

FOR A GOOD **REASON** **GRUNDIG**

en

Owner's Manual

Digital Recording Systems

GRH-K1104B - 4 Channel H.264 HD-SDI Recorder with DVD Drive

GRH-K2108B - 8 Channel H.264 HD-SDI Recorder with DVD Drive

GRH-K4116B - 16 Channel H.264 HD-SDI Recorder with DVD Drive

GRH-K1104B.34.1.26.06.2014

© ASP AG



English

Content

1. Introduction.....	6
1.1 Available Versions.....	7
1.2. Key Features of your DVR.....	7
2. Important Safety Instructions.....	8
3. Package Contents	9
4. Installation	10
4.1. Part Names and Functions.....	10
4.2 Remote Control:	12
4.2.1 Setting the remote control.....	13
4.3. Installation and Connection.....	14
4.3.1. Different configurations	22
4.4. Running the OSD menu	24
4.4.1. OSD Menu Configuration.....	24
4.4.2. Basic Settings.....	25
5. Menu Use	27
5.1. Menu Structure	27
5.2. Function Menu	27
6. Monitoring.....	28
6.1. Basic Screen	29
6.2. Single Full Screen Mode	29
6.3. Multi Screen Mode	29
6.4. Screen Description.....	29
6.5. Sequence Mode.....	30
6.6. Event Screen	30
6.7. Zoom Screen Mode	30

6.8. Pause Live Screen	30
6.9. PTZ Control	32
6.9.1. Pan/Tilt	32
6.9.2. Zoom/Focus	32
6.9.3. Loading Preset	32
6.9.4. Save Preset	33
6.9.5. Auxiliary On	33
6.9.6. Auxiliary Off	33
6.10 Camera Setup	33
6.11. Implemented PTZ camera protocols:	34
7. Playback/Search	35
7.1. Playback/Search Mode	35
7.1.1. Playback on Standard monitor (16 / 9 / 4 division)	35
7.1.2. Playback function.....	35
7.1.3. Screen composition/names of the functions:	36
7.2. Copy	37
7.3.1. CD/DVD	37
7.3.2. EXE	39
7.3.3. AVI	40
8. Configuration.....	41
8.1. System Setup	41
8.1.1. Date/Time.....	41
8.1.2. Disk	43
8.1.3. User Setup	45
8.1.4. Utility	48
8.2. Network	51
8.2.1. Network.....	51
8.2.2. DDNS.....	53
8.2.3. Radius	54

8.3. Device Setup	55
8.3.1. Camera Setup	55
8.3.2. Monitor Setup.....	56
8.3.3. Audio Setup	56
8.3.4. Text Setup.....	58
8.4. Event Setup.....	59
8.4.1. Event Check	59
8.4.2. Event Actions.....	60
8.4.3. Motion Detection	62
8.4.4. Sensor	63
8.5. Recording Setup	64
8.5.1. Continuous / Manual / Schedule Recording Setup.....	64
8.5.2. Program Setup.....	66
9. GRUNDIG Web Viewer	67
9.1. System Requirements.....	67
9.2. Login	67
9.3. User Setup	68
9.4. Available Browser	69
9.5. Monitor.....	69
9.5.1. Screen division and changing video position	70
9.5.2. Playback on Standard monitor (16 / 9 / 4 division)	72
9.5.3. Channel On/Off.....	72
9.5.4. Sensor Indication	72
9.5.5. Relay operation	72
9.5.6. Using a microphone.....	72
9.5.7. Event Data	73
9.5.8. Relay operation	73
9.5.9. Video Recording & Safe Saving.....	73
9.5.10. Using PTZ	74

9.5.11. Using Audio.....	74
9.5.12. Closing Video Channel	74
9.6. Playback.....	75
9.6.1. Video Division & Changing Channel.....	75
9.6.2. Image recording.....	75
9.6.3. Printing	76
9.6.4. Backup	76
9.6.5. Web Monitor	76
9.6.6. Channel On/Off.....	77
9.6.7. Saving Time & Checking Rec. Capacity.....	77
9.6.8. Searching in the Calendar	77
9.6.9. Functions at the bottom of monitor	77
9.7. Java based Web Viewer.....	78
10. GRUNDIG Live Mobile Viewer	78
10.1. Log-In Page	78
10.2. Monitoring Page	80
EC Declaration of Conformity	81
Open Source License Report on the Product	82

1. Introduction

Thank you for purchasing a GRUNDIG digital video recorder for HD-SDI signals. This manual is for GRH-K1104B, GRH-K2108B and GRH-K4116B.

Based on the Television Standard for FullHD Television, HDcctv products feature up to 2 Megapixel (1920x1080) pictures in real-time (30fps) transmitted over coax cabling.

Get the advantages of IP technology without their drawbacks: 16:9 megapixel pictures without network configuration, bandwidth problems and network security risks. Use existing coax cables and only exchange the cameras and recorders. Get a “real” live picture and see the things that happen in the now, not a few seconds ago. Connect a monitor directly to a camera using only a HDcctv-to-HDMI converter. HDcctv is easy to handle, easy to install and produces amazing high quality pictures.

Before product installation and operation, please become thoroughly familiar with this user manual and other manuals referenced by this manual.

This user manual, the software and the hardware described here are protected by copyright law. With the exception of copying for general use within fair use, copying and reprinting the user manual, either partially or in entirety, or translating it into another language without the consent of ASP AG is strictly prohibited.

This specification may change without prior notice for improvement of product performance.

Product Warranty and Limits of Responsibility:

The manufacturer does not assume any responsibility concerning the sale of this product and does not delegate any right to any third party to take any responsibility on its behalf. No warranty is offered for any attachments or parts not supplied by the manufacturer. The product warranty does not cover cases of accidents, negligence, alteration, misuse or abuse, for example:

- Malfunctions due to negligence by the user
- Deliberate disassembly and replacement by the user
- Connection of a power source other than a properly rated power source
- Malfunctions caused by natural disasters (fire, flood, tidal wave, etc.)
- Replacement of expendable parts (HDD, FAN, etc.)
- The warranty period for the HDD and Fan is one year after purchase.

This product is not for exclusive use of crime prevention but also for assistance in cases of fire. We take no responsibility for damage from any incident.

Caution:

This equipment underwent EMC registration and is suitable for business purposes. Distributors and users are aware of this point.

Warning:

This is a class A product. In a domestic environment this product may cause radio interference, in which case the user may be required to take adequate measures.

Warning:

1. In case of changing the built-in lithium battery, it should be replaced with the same or a kindred one to prevent danger of explosion. Since old batteries could be a factor of environment contamination, be cautious how you treat them.
2. Do not throw the batteries into fire or other heat. Short circuit or disassembly is prohibited.
3. Do not charge the batteries provided with the remote control.

1.1 Available Versions

These instructions apply to the following products. For the different properties of the products please refer to the table.

Model	Channels	Recording speed
GRH-K1104B	4	100/120fps
GRH-K2108B	8	100/120fps
GRH-K4116B	16	100/120fps

1.2. Key Features of your DVR

HD-SDI

These products can transfer HD (High-Definition) signal images using the HD-SDI technology via a coax cable. Please note that this product does not accept SD signals.

The supported resolutions are as follows:

- SMPTE 274M : 1920x1080p 25/30Hz

Monitoring Screens

These products support real live video with high resolution for each channel and with variable display modes.

- Various monitoring Multi Views (Single, 4 screen division, 8 screen division, 16 screen division)
- Covert channels for users

Audio Recording

These products support real-time audio input and recording.

- Simultaneous 4ch audio input & recording available
- Input : 4ch RCA, Output : 1ch RCA , 1ch HDMI
- Simultaneous audio recording and playback available

HD-SDI video recording

GRH-K1104B : 1920 x 1080 (1080P) : 1200ips GRH-K2108B : 1920 x 1080 (1080P) : 120ips GRH-K4116B : 1920 x 1080 (1080P) : 120ips

- Supports manual, continuous, schedule & event recording
- Video loss detection
- Supports archiving an event list (Sensor, Video loss, Motion detection, Text)

Search / Playback

These products support variable and convenient functions for search & playback.

- Search for Events (Motion, Video Loss, Text & Relays)
- Search for Dates (Calendar & Date input method)

- Smart Search for Motion Detection
- All Search methods can be used via DVR, remote control & USB mouse
- Supports various backup devices : DVD-R, USB
- eSATA port for external recording HDDs

Network

These products support networks like LAN, XDSL and can be easily controlled from remote site using the GRUNDIG Control Center Software.

- E-mail and/or Twitter notification
- Access Live video and playback with many Web browsers, backup with the Internet Explorer
- Access Live video, playback, search, backup and DVR management with the GRUNDIG Control Center Software
- Access Live video and playback with the GDViewer app, available for iOS and Android devices
- Record, search & playback over a network
- 10/100Mbps Ethernet/xDSL connection

ETC

- User friendly GUI with mouse function
- Easy and simple firmware upgrade over USB or the network
- PTZ Control (several protocols), PRESET function
- Control of up to 16 DVRs with one remote controller
- 10/100/1000Mbps connection for the external storage device GDS-R04A
- Advanced user management with covert function
- 2-men principle password function integrated

2. Important Safety Instructions

1. Do not place heavy objects on the top of the product.
2. This Product is for indoor use. It is not weatherproof. Please use the product considering its environmental specifications (Temperature & Humidity). To clean the product, gently wipe the outside with a clean dry cloth.
3. This Product uses AC power of 110V ~ 240V. Be cautious not to cause electric damages to the product.
4. Be careful not to drop the product. Physical shocks may harm the product including the internal HDD. In addition, be sure the product is secured after installation.
5. This Product is made of metal. Therefore you can hurt human beings if you throw it to them or hit it on them. When installing the product, be cautious to locate it in safe places where children cannot reach it.
6. If the product does not operate properly, please contact the closest GRUNDIG distributor for after sales service. Tampering or disassembling the product will cause expiration of the warranty.
7. Security surveillance laws may differ for each country. Therefore, please contact the local region first to avoid any surveillance law violations.
8. Experience and technical skills are needed for the installation of this product as an improper installation may cause fire, electric shocks, or defects. Any installation job should be performed by the vendor you purchased this product from.

The content of this manual can differ according to firmware or software upgrading. The standard and appearance of the products may be changed for the improvement of quality without prior notice.

3. Package Contents

These parts are included:

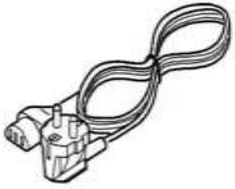

AC Cord

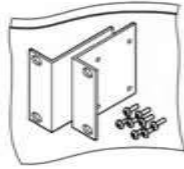

Bracket

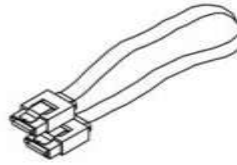

SATA HDD Cable
[built-in]



Screws for HDD



USB Mouse

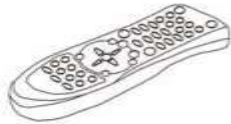

Remote Control
[battery included]

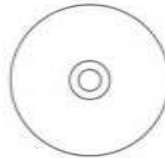

Setup CD

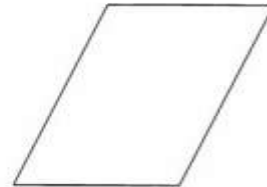

Quick Guide

4. Installation

4.1. Part Names and Functions

Front view:

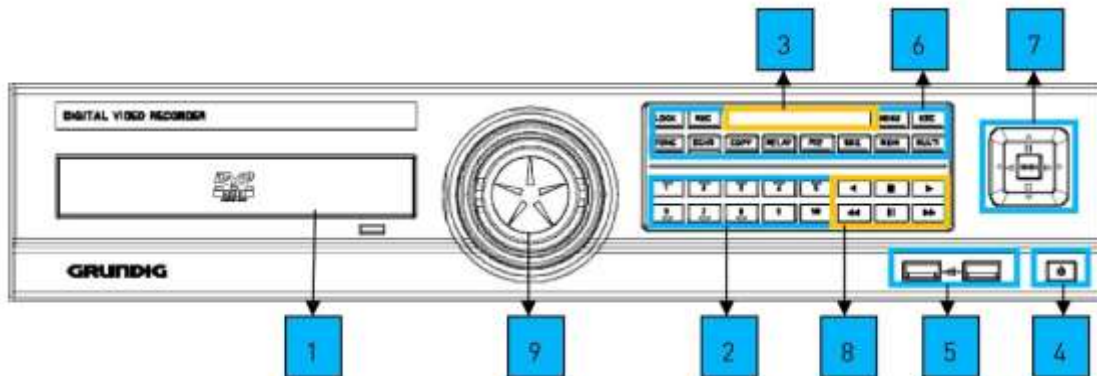

Item	Description
1	DVD-Multi (for Backup) Backup of recorded data by DVD/CD media
2	Channel Buttons To select a video input channel
3	REC LED Displays the recording status
	COPY LED Displays the copy status
	HDD LED Displays the running HDD
	NET LED Displays the network connection
	EVENT LED Displays event detection
4	Power To turn the power on/off
5	USB port For connecting with USB memory or mouse
6	REC To start or stop manual recording
	MULTI To change the DIVISION in live or playback mode
	SEQ To run or stop a user sequence
	COPY To enter copy mode
	SEAR To enter search mode
	PTZ To start or stop the PTZ function
	FUNC To enter the function menu
	RELAY Manual On/Off button for relay
	MON To change the monitor
	MENU To enter the menu
	ESC To exit the menu or close a pop-up window
7/8	Enter/Play ▶ To enter playback mode or select a menu
	◀/REW ◀◀ To move or select in the menu and to change the replay speed in reverse direction in playback mode
	▶/FWD ▶▶ To move or select in the menu and to change the replay speed in forward direction in playback mode
	▲/Pause II To move or select in the menu and pause live/replay video
	▼/Stop ■ To stop replay in playback mode
9	Jog/Shuttle STEP function control, Playback direction change, Playback speed control

Rear view:

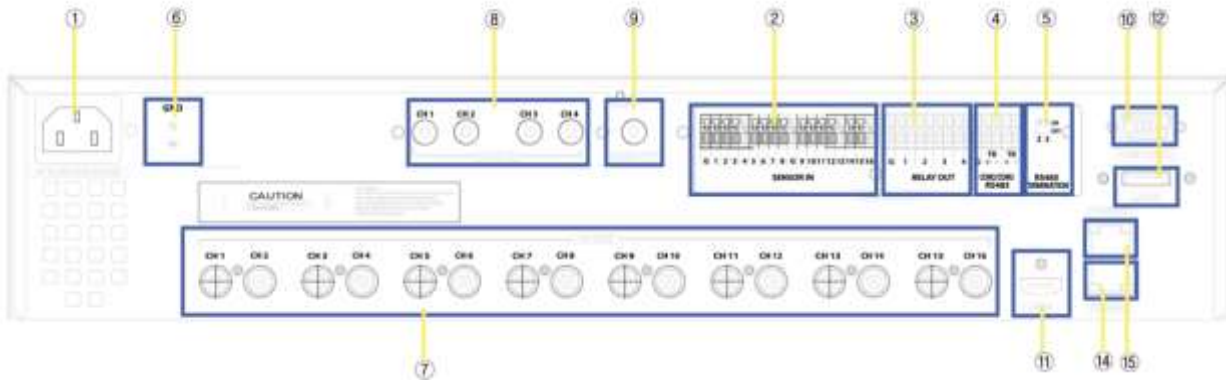

Item		Description
1	Power In	AC100V~AC240V power cord socket.
2	Sensor IN	External sensor input terminal
3	Relay	Relay connect terminal
4	COM2,3	Connct RS-485
5	RS-485 terminating resistors	Set terminating resistors when using RS-485 method
6	Ground connection	Connection terminals that connects DVR to an outside device
7	Channel input	Input connection terminal for BNC of a HD-SDI camera
8	Audio input	Audio input connect terminal.
9	Audio output	Speaker output terminal.
10	COM1	RS-232C D-SUB.
11	HDMI Output	Output port on which HDMI monitor can be connected
12	eSATA port	eSATA external HDD is connected
13	N/A	
14	Storage	Exclusive network storage device(NS0104R) is connected and used
15	ethernet	network connecting terminal (RJ-45)

4.2 Remote Control:

It is possible to use all functions of the DVR with the remote control,. If several DVRs are set with unique ID numbers, they can be controlled with one remote control. To use the remote control, it is necessary to set first the ID which you want to use. Keep pressing the ID button repeatedly (up to max. 16 times) and use it for matching DVR & ID.

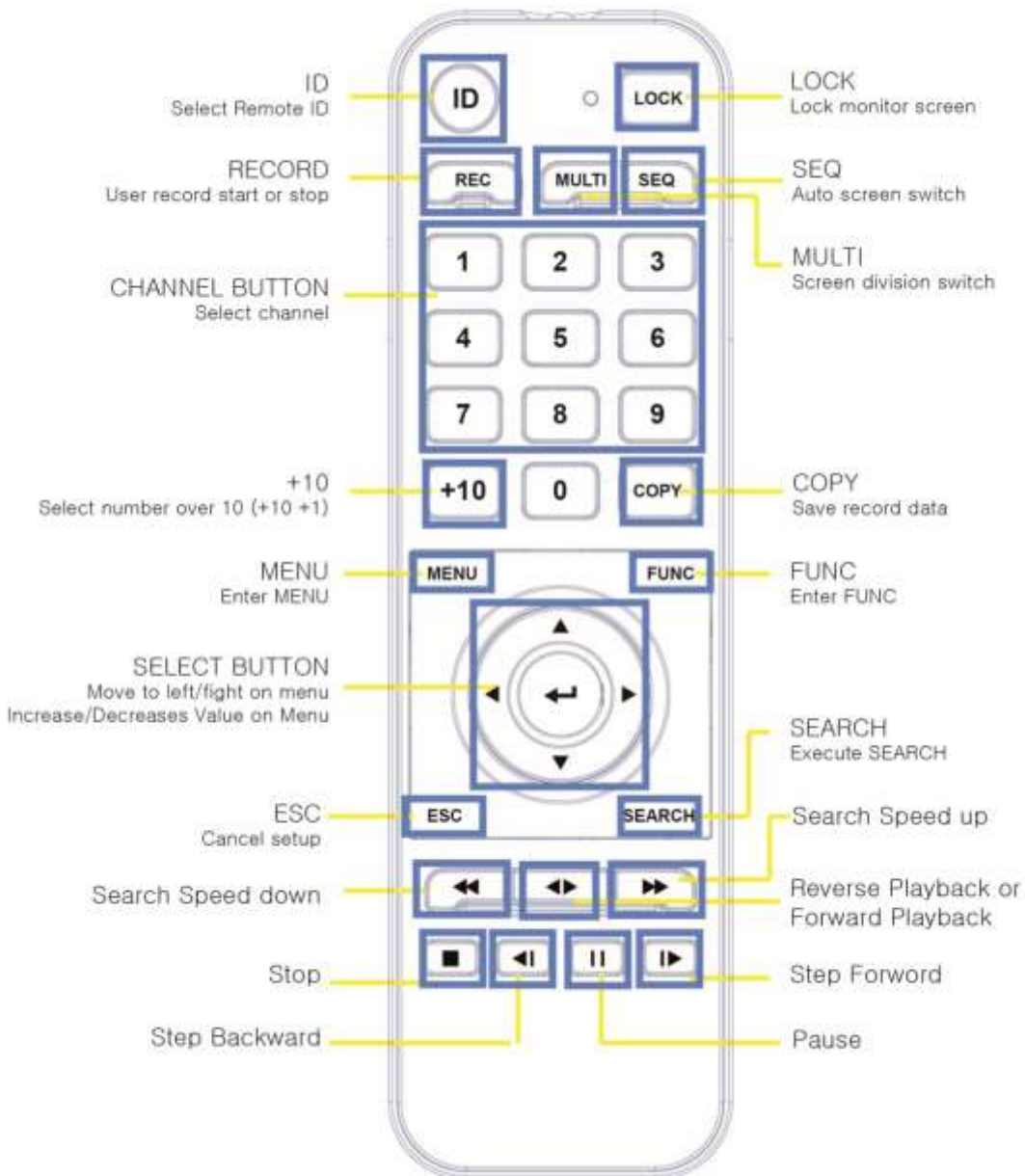

4.2.1 Setting the remote control

Setting the ID of the DVR:

When controlling several DVRs with one remote control, set the Remote Control ID as follows:



- (1) Press the [MENU] button.
- (2) Select “System” by using the [▶] arrow button and press [Enter] or the [▼] button. (3) Select “Utility” by using the [▶] arrow button and press the [Enter] button.
- (4) Select “Remote Controller ID” and press [Enter].
- (5) Select a value using the [◀ / ▶] arrow buttons and press [ESC]. (6) Press the [ESC] button to return to monitor mode.

NOTE:

Up to 16 DVRs can be controlled with a single remote control. If you do not use a remote control, set the Remote Controller ID to “All”.

Selecting an ID with the remote control:

If there are several DVRs with unique ID numbers, they can be controlled with one remote control. To select a specific DVR, keep pressing the ID button of the remote control until you hear a signal sound for the duration of 2 seconds.

Operable range of the remote control:

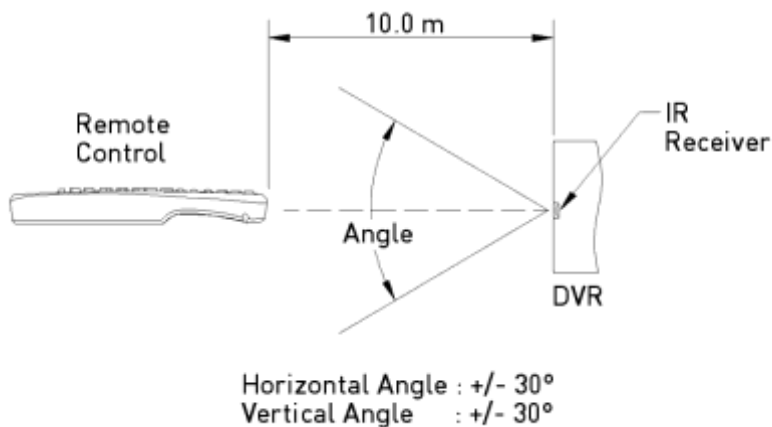

Loading the batteries into the remote control:

The remote control requires two AAA-type batteries. Please refer to the following installation steps.

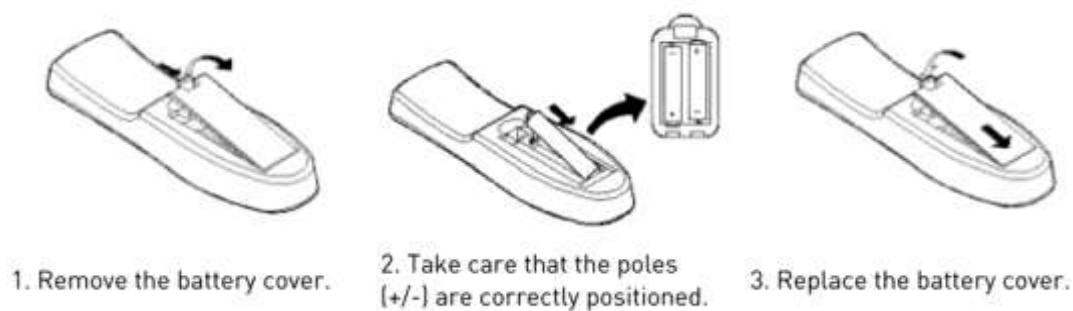

4.3. Installation and Connection

Check settings

This DVR is high quality security device with a high capacity built-in HDD and important circuits. Before installation, please read carefully below recommendations as high internal temperature of the product can lead to damages and shorten product life cycle.

Recommendations on installing a DVR in a rack:

Don't seal the inside of rack where DVR is installed.

Keep airflow through inlet and outlet.

If there is another device installed in the rack, secure additional space or install air ventilation.

Installation of an air circulation fan around each inlet and outlet is strongly recommended.

(Install filter around inlet or outlet for harmful substances)

Keep ambient temperature between 5°C~45°C around DVR.

Warnings if HDD is installed

Please be extra careful not to damage HDD as it easily breaks.

During installation, make sure insulated coat doesn't come off or isn't placed in the wrong place.
Don't lose screws and parts.
(If screws and parts are not screwed or assembled correctly, product may not operate)
Check HDD compatibility list HDD
Partition table must be removed for HDDs used in PC or other DVR models before installation.

HDD installation *

1. Unscrew bracket screws that are fixing it to a DVR..

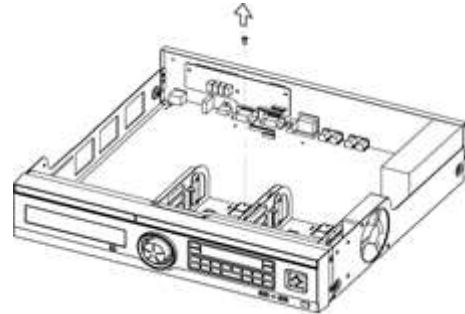

2. Push HDD bracket to a direction shown in the right picture and separate from fixtures.

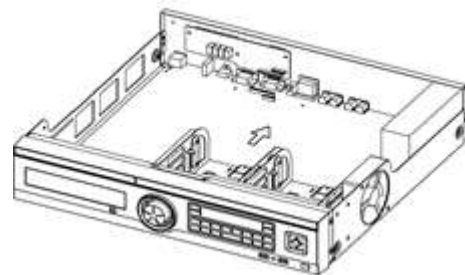

Lift HDD bracket to a direction shown in the right picture and separate from the bottom.

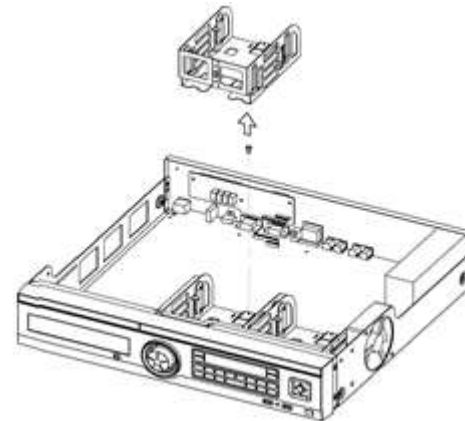

Place HDD in a HDD bracket and fasten 4 screws on each side.

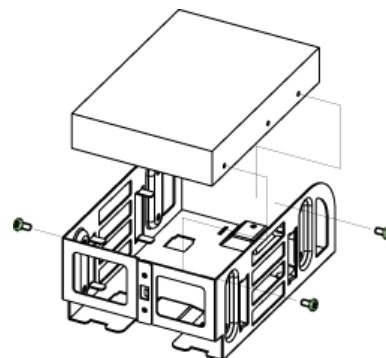

Place HDD bracket fastened with screws in DVR and fasten it on the bottom with screws.

NOTE:

Below is SATA cable socket sequence of a mainboard.
Up to 5 HDDs can be installed inside DVR.

Main Board	Disk Manager
INT A	INT A
INT B	INT B
INT C	INT C
INT D	INT D
INT E	INT E
eSATA	eSATA

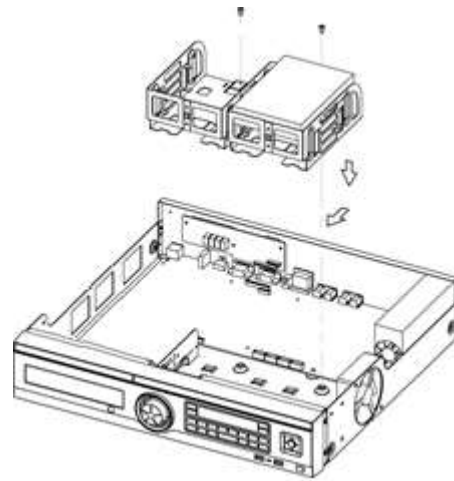

Adding HDD:

Remove the power cord before installation to protect DVR against possible damage and an electric shock. Please call the store you purchased the product from if it isn't operating correctly due to installation or configuration mistakes.

Warnings regarding Data loss:

Please handle with care so HDD data isn't damaged.
Check HDD compatibility before installing additional HDD.
Be careful not to give any shock on HDD during operation which could lead to possible damage or malfunction.
Cases when HDD and its data can be damaged.
To minimize the data loss, please copy data as often as you can.
Physical shock during disassembly or installation may lead to Data damage.
Sudden power outage or turn off of DVR can damage HDD.
Please don't try to move or shock DVR while HDD is working.

Connecting the camera:

Connect the CCTV camera to the DVR using the BNC cable as shown below:

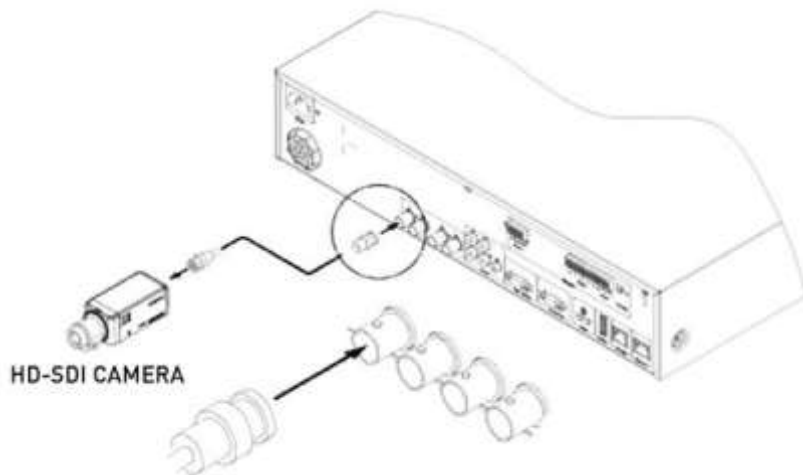

Please make sure that all connected cameras fulfil the SMPTE standards 296M or 274M, or a compatible one. The DVR will recognise the camera automatically. If you do not get a video, please check the connections first and then make sure the distance is not too far for HDcctv signal:

Recommended cable *

Cable Type	HD-SDI transmission distance	Use
5C2V	about 90M	Analog signal
4C-FB(T), 4C-HFB(T), RG59	about 140M	High-foamed cable, double or triple shielded cables are recommended
5C-FB(T), 5C-HFB, L-6CHD, RG6	about 180M	HD-SDI cable
5C-HFBT	about 200M	HD-SDI cable

* Depends on manufacturer and models.

<warnings>

Transmission distance will be affected by cable types and installation site environment

Transmission distance of the chosen cable will be various based on reduction rate of 750MHz (reduction rate of dB/100m < 25dB is recommended)

Foamed or high-foamed trishield cable is recommended.

Impedance 75Ω must be used for coax cable connection and connector work.

Beware of deformation of cable due to high pressure over the cable.

Don't pull the cable with too much force.

For DVR input/output, cables will be tied at the rear of the rack. If tied too tightly, inside/outside insulator can be deformed so tie it loosely within cable's curvature range.

For bigger distances, please use the GTH-L0011E extender from GRUNDIG.

Connecting a monitor:

Connect a CCTV monitor using a HDMI cable with the corresponding port.

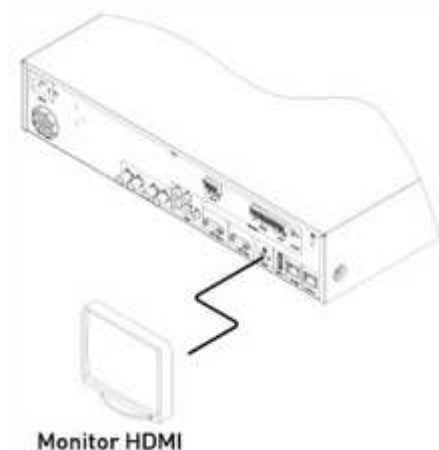

Connecting Audio:

Connect the audio signal to the DVR using the RCA connector as shown below:

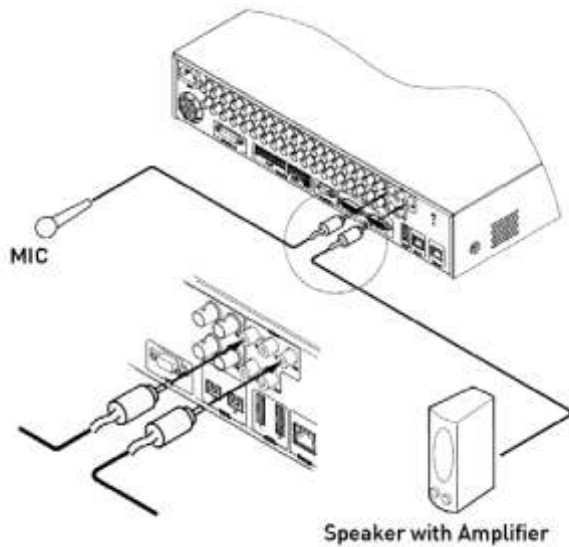

Supplying Power:

Connect the power cable as shown below:

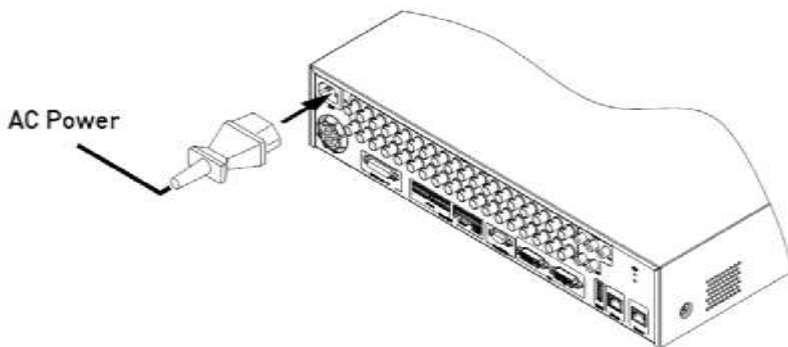

- When supplying the DVR with power, the DVR starts booting automatically.
- In order to cut off the power, press the power switch on the DVR front for 5 seconds. When a pop-up window appears, select "YES" to shut down the DVR.
- For supplying the DVR with power again, push the Power button.

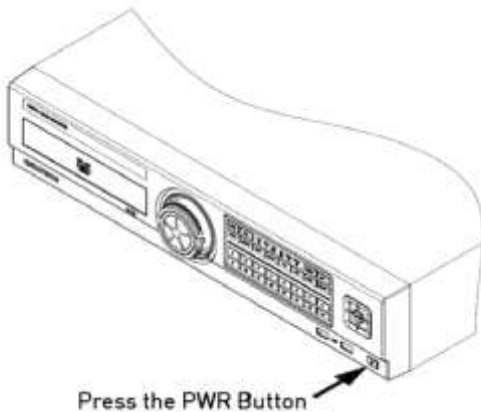

Connecting external device:

Connecting USB Device

USB port can be used for copy of recorded data and for mouse.

See below table for USB Device specifications.

USB specifications	Ver 2.0 or later
Usable device	USB Stick
Voltage specifications	DC 5V / Max. 200mA

NOTE:

USB stick needs to be FAT32 formatted.

DVR may not recognize USB Flash memories that require additional program on MS Windows.

Connecting eSATA Device :

If external eSATA storage is used, it can be connected to a rear eSATA port. Additional power for eSATA device will be required as DVR doesn't supply power.

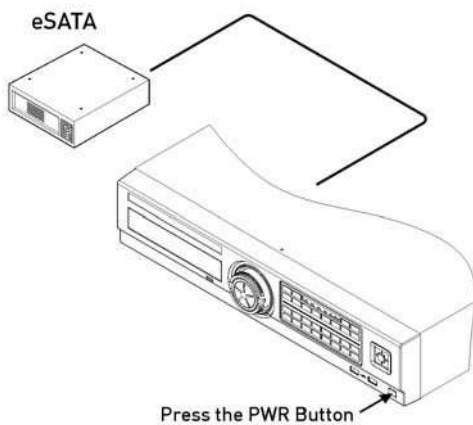

NOTE:

1. Check compatibility of eSATA with DVR as not all eSATA are compatible with DVR.
2. If eSATA is connected to DVR when it is on, it may not be recognized depending on external devices. So we recommend following the below steps.
 - 1) Turn off DVR.
 - 2) Turn off eSATA then connect it to DVR.
 - 3) Turn on eSATA.
 - 4) Turn on DVR.

Connecting input/out terminals:

Wire end handling

See below for wire end handling used in terminal block. Please work on single line and multiple line as they have different thicknesses.

- Multiple lines : Peel off the recommended length(8~10mm) and lead-coat it. Use AWG 22 ~ 26.

- Single line : Peel off the recommended length(8~10mm) and use AWG 20 ~ 26.

Wire insertion/removal

As shown in the picture, push the lever to insert or remove a wire.

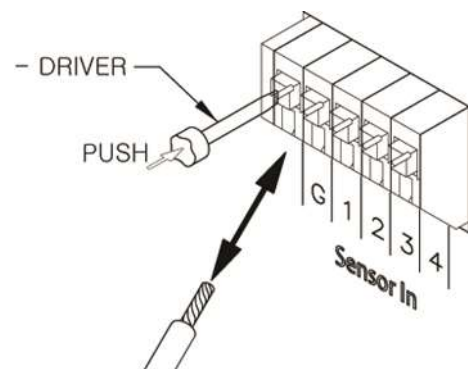

Connecting a sensor:

Specification:

below requirements need to be met in order to connect the sensor

Specifications	Input Channel #	16EA Transistor input
	Input Type	N.C, N.O support
	Supported sensor	Dry contact sensor
	Connection method	Connect the trimmed wire to terminal block
Performance	Available input pulse range	Minimum 500ms
	Output current	Standard DC 12mA

Connecting sensor input terminal:

Please see the picture for sensor input. The below picture is an example of connecting Dry Contact sensor type. Please refer to “Wire Handling” for more information.

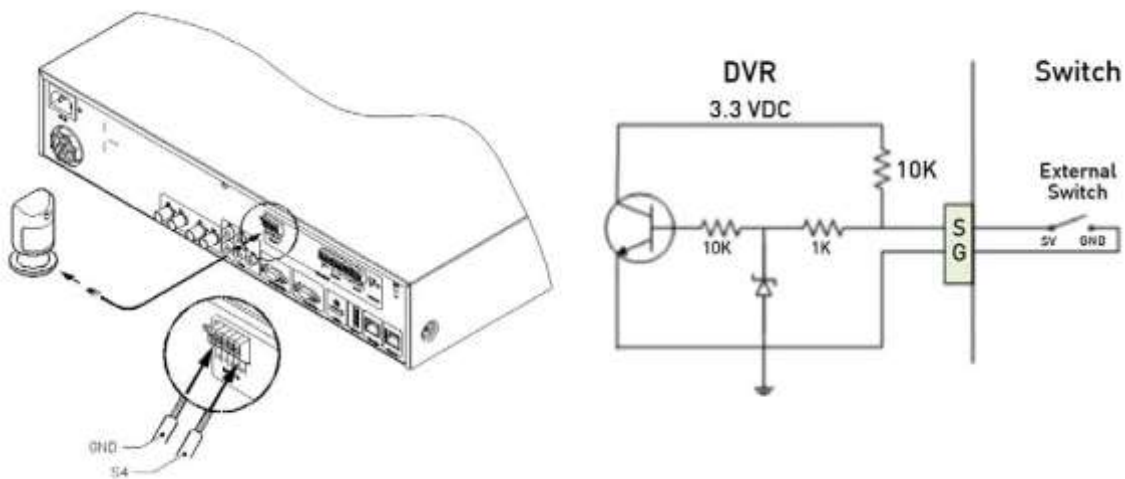

Connecting a Relay:

Specifications:

Please see the below table for alarm output requirements.

Specifications	Output Ch.	4ch relay output
	Output type	Dry Contact
	Connection method	Connect the trimmed wire to terminal block
Performance	DC	30V / 1A
	AC	125V / 0.5A

Please refer to the below picture in regards to connecting R1~R4 output. Below picture is an example of connecting a light bar. Please see “wire end handling” in regards to connecting/removing wires.

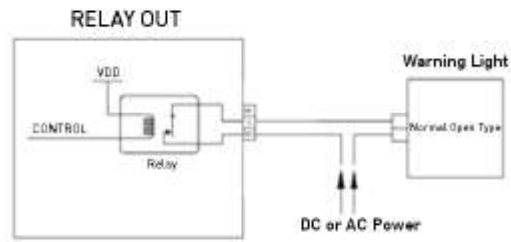
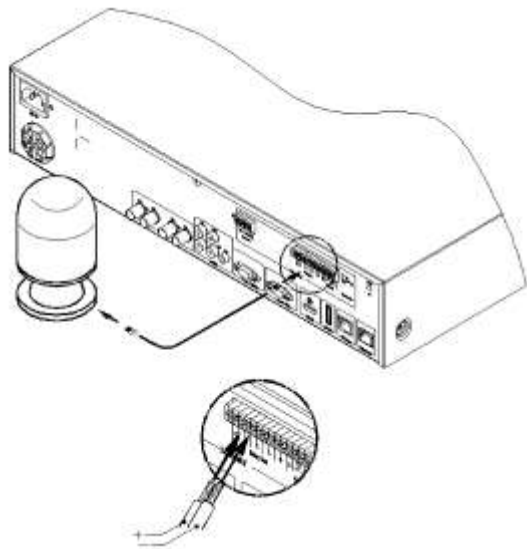

Connecting COM1 serial port with external devices:

Connecting Text input device (ATM / POS / Access Control)
Using COM1/RS232, TEXT DATA can be recorded with synchronizing POS/ATM.

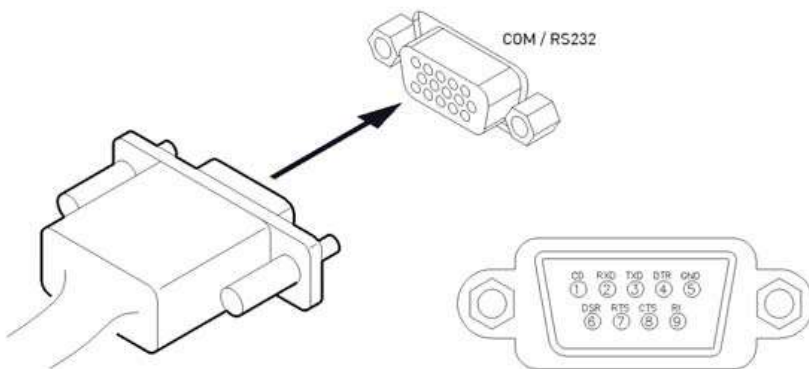

As shown in the picture, for a set up to connect COM1/RS232 (D-Sub 9pin), set up serial & text info under “device” menu.

Connecting COM2/COM3 serial port external device:

Connecting serial communication terminal for PTZ device & Keyboard device

Control PTZ devices and Keyboard devices by connecting them to DVR’s COM ports. Picture in the right shows how a camera and a keyboard device with PTZ function are connected to RS-232 COM1 & RS-485 COM2 respectively. Other serial communication terminals will be connected to other devices as shown in the below picture. To connect or remove a wire, please refer to the “wire end

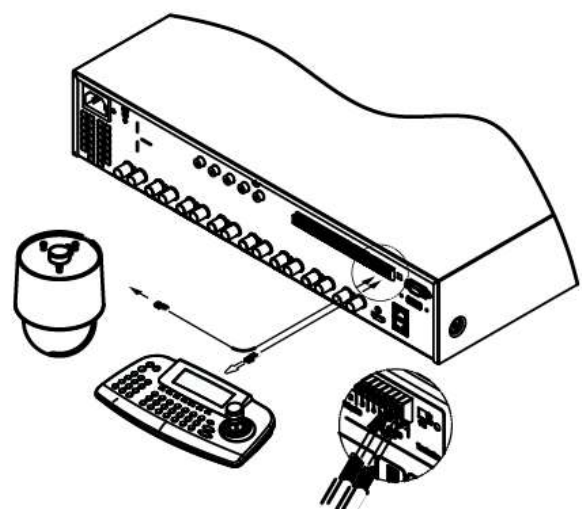

handling” and supported models can be checked on “compatible PTZ & Keyboard device” on the supplement booklet.

Connecting Serial Port for Transparent device:

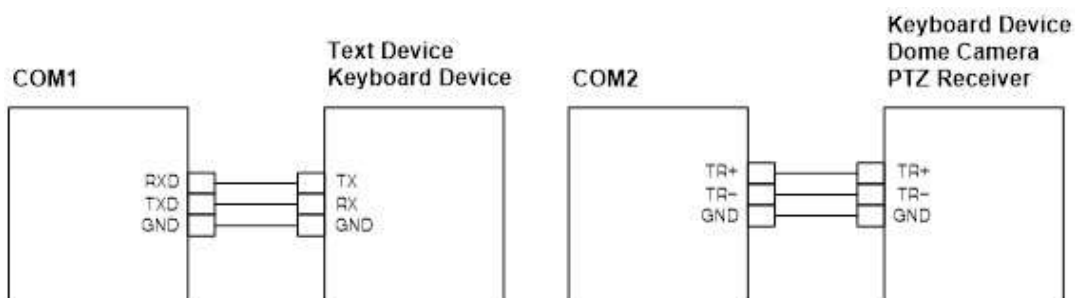

Specifications	Output Ch.	4ch relay output
	Output type	Dry Contact
	Connection method	Connect the trimmed wire to terminal block
Performance	DC	30V / 1A
	AC	125V / 0.5A

Connecting PTZ & Keyboard:

up to 255 DVRs can be connected using keyboard and PTZ control is possible for all channels connected to DVR. Also, multiple keyboards extension as Slave can be used limitless with Master Keyboard. In this case, Master Keyboard has priority for all controls. Please refer the instruction manual for PTZ keyboard connection & its way of control which comes with PTZ/ Keyboard.

Configuration using 2 serial ports

PTZ(DOME) and Keyboard can be connected to DVR’s 2 serial ports. In such case, keyboard can control DVR and PTZ(DOME) at the same time, and DVR can control PTZ(DOME).

4.3.1. Different configurations

Basic configuration:

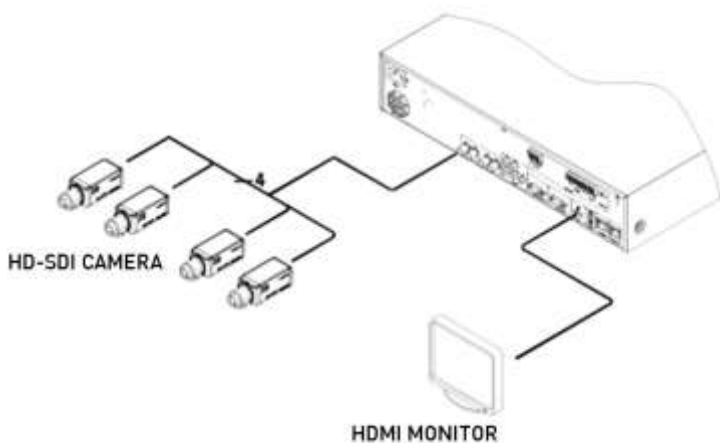

Advanced configuration:

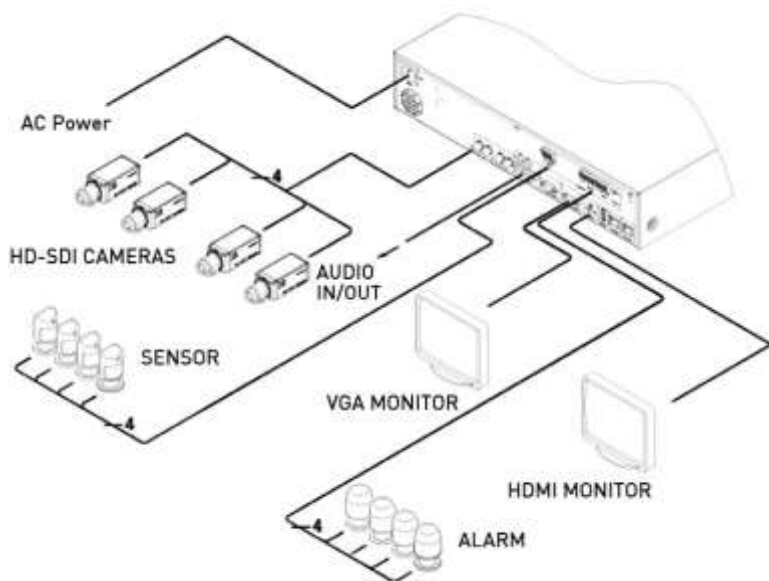

Connection to an USB storage device for backups:

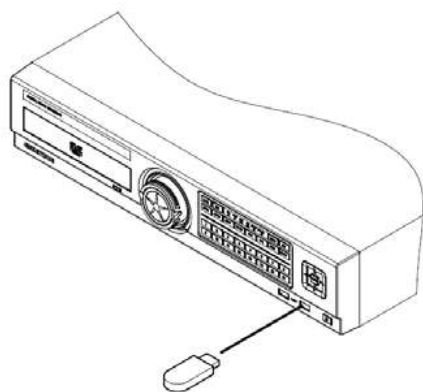

USB Storage for Copy

Internet/Intranet configuration:

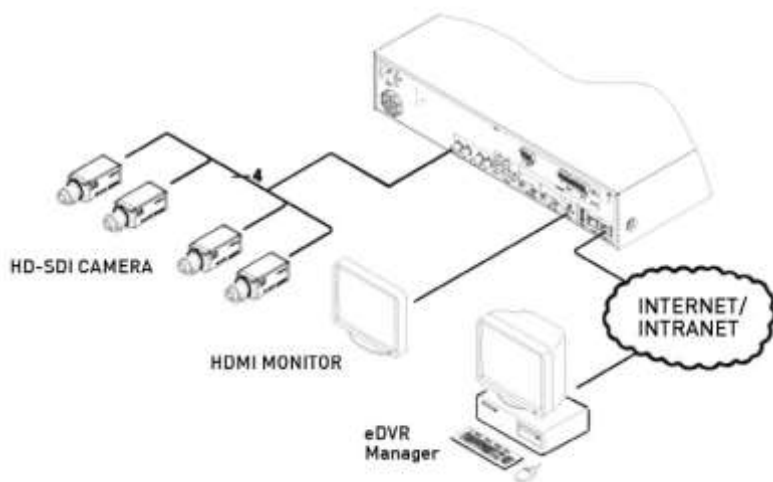

4.4. Running the OSD menu

The OSD can be controlled with the keypad on the front panel of the DVR, with a remote control or with an USB mouse. In this manual we will refer to the keys of the front panel, as the procedure with a remote control and a mouse is almost identical.

4.4.1. OSD Menu Configuration

Press [MENU] on the keypad on the front to open the configuration menu as shown below:

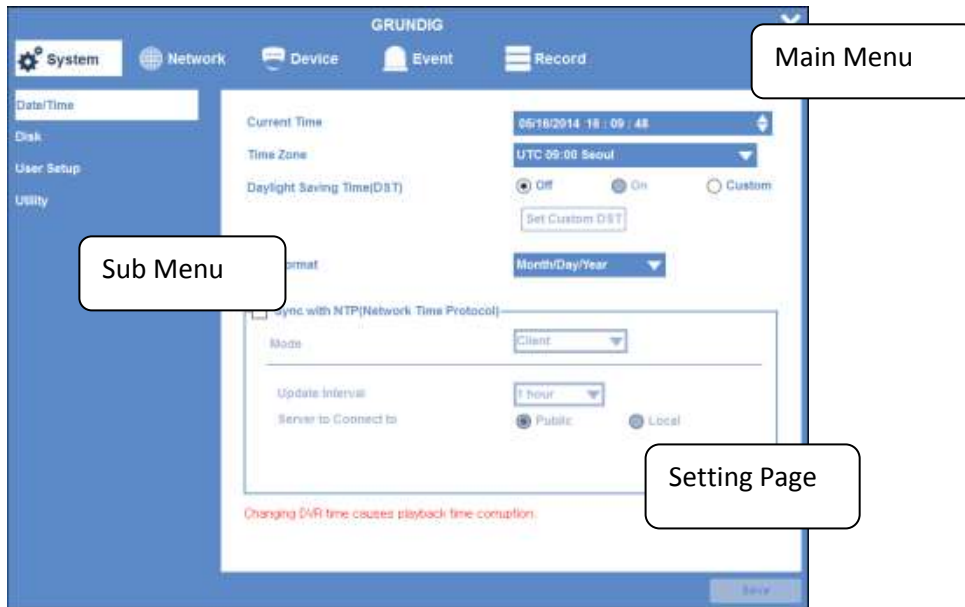

(1) Main Menu : The selected tab is shown in white colour and the related sub-menu will be shown on the left, below the tab. To move to the previous/next tab, use the [◀ / ▶] arrow buttons. To move to a sub-menu, press the [Enter] key.

(2) Submenu : The selected sub-menu is shown as a tab title and the related setting will be shown. To move to the previous/next tab, use the [◀ / ▶ , ▲ / ▼] arrow buttons. To move to the related setting, press [Enter]. To move to an upper main menu, press the [ESC] button.

(3) Setting page : The selected tab is shown in blue. To move to the previous/next tab, use the [◀ / ▶] or [▲ / ▼] arrow button and press the [Enter] key for value setting. When setting the value is a word, a dialogue box to edit the word will open. When setting the value is a number, it should be set with using [◀ / ▶] or [▲ / ▼]. Press the [ESC] button when the value is set. With the [ESC] button it is also possible to move to the upper sub-menu.

Dialogue box to edit a word:

The dialogue box to edit a word is shown below. It is possible to input both letters and numbers.

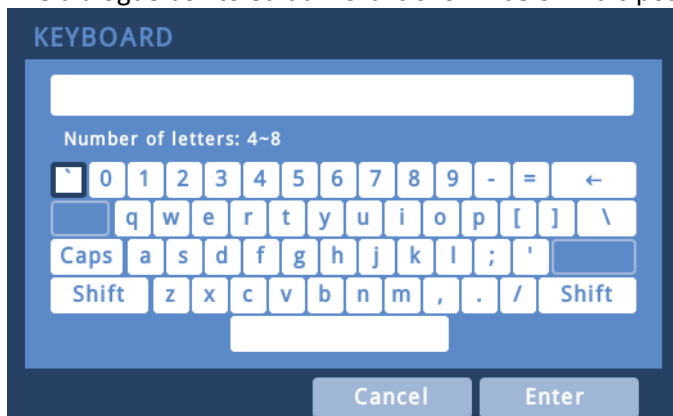

Keep pressing the [▲/▼], [◀ /▶] arrow buttons until the word is typed in, then press [Enter]. In case of deleting press [←], for spacing press the [→] button. To exit the dialogue box, press [Enter] after having finished the word input.

4.4.2. Basic Settings

Viewing Image:

When powered on, the DVR starts automatically and displays a basic 4 ch-split (GRH-K1104B) , a 8-split screen (GRH-K2108B) or a 16-split screen (GRH-K4116B).

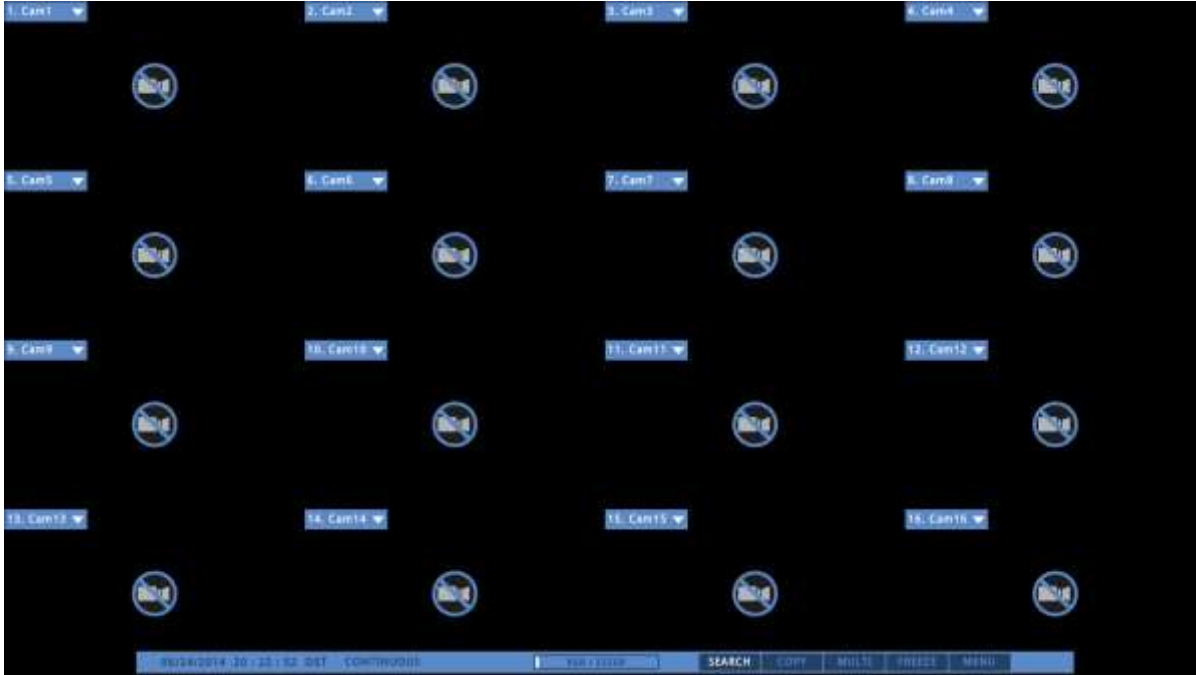

NOTE:

After booting the recorder, by default a prompt for entering the password will appear. The default admin password is: 1234.

Setting Date & Time:

- Press the [MENU] button and select “System” when the OSD menu appears.
- Select “Date/Time” and press the [Enter] button.

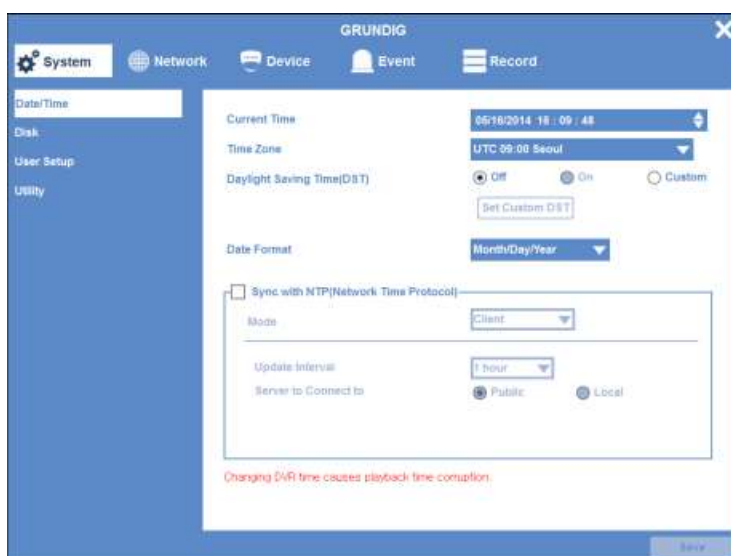

Standard time zone

Use the left or right arrow key on the front or the mouse wheel to select your time zone. (In order to go to the previous menu, press the [ESC] button on the front or click "X" with a mouse. This is the same for all OSD menus.)

Daylight Saving Time (DST)

On the "time zone" setting, "on" will be chosen when users click on regions where daylight saving time applies and "off" will be chosen when regions without daylight saving time are chosen.

Users can check "off" if they don't need daylight saving time function for a region where daylight saving time applies.

Please select "custom" if users want to set their own daylight saving time preferences. Select "custom" and the DST setting will appear. ??? "month/day" will set DST start/end at month/day/hour and "month/week/day" will set DST start/end at month/week/day/hour.???

NTP function

Please set the NTP 'On' then select 'Public' in Client Mode for the DVR to set the time automatically via internet connection.

Date Notation

Please select "Date Format" by choosing 'YYYY/MM/DD, MM/DD/YYYY or DD/MM/YYYY.

Recording configuration



[continuous recording]

[manual recording]

[schedule recording]

Continuous recording

Continuous recording will automatically begin after booting is completed and continuous/event recording will begin according to the chosen program values.

Manual recording

Push the REC button on the front panel to begin/end manual recording and manual/event recording will begin according to the chosen program values.

NOTE:

If manual recording is chosen, exit the menu and check the manual record indicator on the status bar to confirm recording. If there is no manual recording indicator sign, press the REC button on the front panel to begin recording.

Schedule recording

Schedule recording will begin according to a pre-set day/time schedule. Set day/time on "schedule setting" under the schedule recording mode.



Program configuration

Please set the resolution, frame rate, and picture quality of each individual camera per channel in “Program menu” under the record setup.

<Reference>

How to check if it’s recording: When the settings are correct and recording has started, the “REC LED” indicator on the front will be flickering. Also, the status bar’s save indicator will show [SCHEDULE], [MANUAL], or [continuous] indicating that all channels are recording. The “REC LED” is turned off when the DVR is not recording.



5. Menu Use

5.1. Menu Structure

The menu structure is shown in the image below. The settings for each menu are explained in the following chapters.



5.2. Function Menu

To run the Function menu, click the right mouse button in the live monitoring or playback status or push the “Func” button on the front panel.

The Function menu enables every function of the product to be controlled by USB mouse. Each function can be executed by clicking the left mouse button.

The Function menu can also be controlled by the front panel buttons.
Please refer to the picture on the right for the Function menu structure..

Function Menu in Live Mode:



Function Menu in Playback/Search Mode:



6. Monitoring

All HD-SDI video image channels connected to the DVR are displayed on the screen after booting the DVR.

6.1. Basic Screen

The basic screen shows a multi screen with all channels supported, if the multi screen has been modified and the DVR is being rebooted, the default multi screen will be shown.

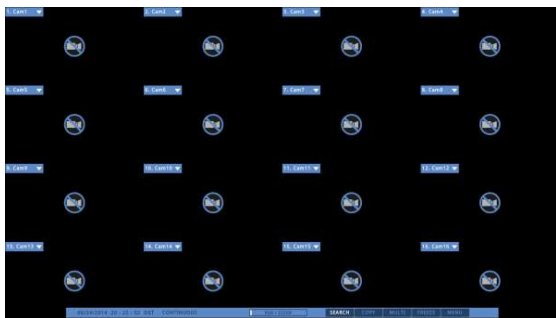

6.2. Single Full Screen Mode

After the power connection is established, the DVR will boot automatically. After booting, the user needs to put in his user password. In the default settings, only the admin has the rights to see the channels, therefore no user will see any video at the first boot.

Depending on the model you will either see a 4ch or 8ch split view.

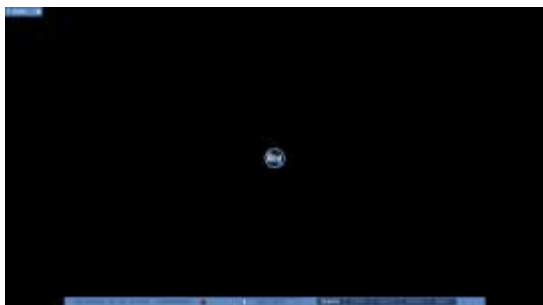

Press the wanted channel number or click with the mouse on the wanted channel. Double-click with the mouse to return to the previous multi-channel view.

You can select different Multi-channel views by clicking the [MULTI] button on the front panel or the [Display] button in the function bar.

6.3. Multi Screen Mode

Press [MULTI] for multi channel display or click the "Multi" function in the Function menu. Every time you press the [MULTI] button, the screen mode will change.

For GRH-K1104B you only have the 1-4 channel multiview.

For GRH-K2108B you also have the 5-8, 4C & 1~8 multiview and for GRH-K4116B the 5-8, 4C & 1~16 multiview .

6.4. Screen Description

The status bar from the monitoring screen shows the DVR's current status which includes Date/Time, Record, Motion/Sensor Detection, Manual Record, Text Input and HDD's Record capacity.



6.5. Sequence Mode

Auto switch screen mode is a feature in which the selected channel or multi screen division switches in a sequence with the time interval of 1 – 60 seconds.

(Please refer to “Monitor setup” for further configuration methods).

Auto Switch mode can be set in every division mode by pressing the [SEQ] button.

Press the [SEQ] button once more to exit the Auto Switch mode.

6.6. Event Screen

Users can set the selected screen to pop-up automatically when an event is triggered.

Users can choose events that trigger the pop-up from the event source. Event source supports 3 types of events: Sensor, Motion Detection & Text.

If multiple events are triggered, the corresponding screens will pop up automatically.

For example, if events are triggered in 3 Channels, they will be displayed in a 4 screen division automatically.

To return to the original channel, press the button of one of the popped up channels.

Press [ESC] to return to original channel.

NOTE:

If Alarm pop-up is “Off”, Event pop-up will not be enabled.

If event screen switch is set to “Keep”, it keeps showing pop-up image until the user presses a button. To return to the previous screen, please press any button.

6.7. Zoom Screen Mode

By using D-Zoom on a single screen, users can enlarge the section they want to view.

Press [ZOOM] on a single screen in a full screen mode or press D-Zoom while pressing [FUNC] to enable D-Zoom mode. Use “+,-” or drag a mouse to enlarge/reduce the screen.

The initial location of the enlarged screen is the center. Use the direction keys to move the enlarged image 22 steps to left/right and 14 steps up/down.

Enlarge mode can be used between a 1.00X ~ 10.00X range. To return to the previous screen, select a button and press enter or left click the mouse.

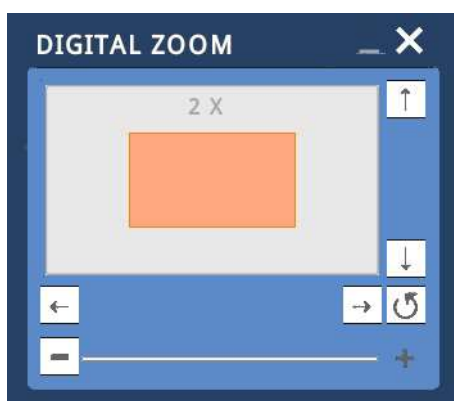

6.8. Pause Live Screen

Just like in playback, Live screen can be paused.

Press the PAUSE button to pause the live display, press any button to return to the live display.

6.9. PTZ Control



Connect a PTZ controller to the DVR and set the relevant protocol in the “Serial Setup” menu and the corresponding camera menu, then the PTZ of the camera can be operated while live monitoring is activated. To pan and tilt a PTZ camera, use the direction keys from the DVR’s front panel or the mouse. You can access focus, zoom and presets of the PTZ camera by pressing the PTZ button on the DVR’s front panel or clicking on the PTZ icon in the Function menu.

Below you find a list of supported protocols.

Instant PTZ

PTZ mode will automatically be on if Instant PTZ switches a set channel to a single screen. + sign will appear in the middle of the screen if PTZ is operating.



- Press the button of the desired channel, or select the channel with the mouse.
- Press the PTZ button from the front panel or click on the PTZ icon in the Function menu with the mouse.
- The PTZ menu (Zoom/Focus, Load Preset, Save Preset) will appear.
- Then press the [Enter] button or click on the mouse.

6.9.1. Pan/Tilt

The Pan/Tilt function is directly activated after you have chosen a PTZ camera in single monitor mode. You can control the PTZ with the front panel direction buttons, or with the USB mouse by clicking on the screen. Depending on the distance to the central cross, the PTZ will move into the direction of the mouse click.

6.9.2. Zoom/Focus

This menu is used to control the Zoom & Focus function in real-time monitoring mode.

- Select Z/F (Zoom/Focus) from the PTZ mode.
- Control Zoom/Focus through the direction keys on front of the DVR or use the scroll wheel of the mouse.

6.9.3.

Loading Preset

This menu is used to move the PTZ camera into a Preset position during real-time monitoring mode.

- Use the Up / Down buttons or the mouse wheel to select the Preset Number.
- Once Preset is configured, please select [Load] and then press [Enter].

6.9.4. Save Preset

This menu is used to set a new Preset position during real-time monitoring mode.

- Control the PTZ camera location by using the 'Pan/Tilt' menu and the 'Zoom/Focus' menu.
- Use the Up / Down buttons or the mouse wheel to select the Preset Number.
- Once the preset position is configured, select [Save] and then press [Enter].

6.9.5. Auxiliary On

This menu is used to utilise specific functions of a PTZ device during real-time monitoring mode.

- Use the Up / Down buttons or the mouse wheel to select the Aux Number.
- Select the relevant Number button for this specific function (Up to 16 functions of the PTZ camera can be controlled with the Aux Function.)

6.9.6. Auxiliary Off

This menu is used to stop operation of a specific function of the PTZ device.

- Use the Up / Down buttons or the mouse wheel to select the Aux Number.
- Select Off and press the [Enter] button or click on the mouse.

6.10 Camera Setup

Used to enter the menu of the connected PTZ device.

Use the direction keys and the enter button to set up the menu. Press esc or “ ” to exit the menu.



6.11. Implemented PTZ camera protocols:

Model	Manufacturer
BOSCH AutoDome, TC8560X-4	Bosch
PELCO(P), PELCO(D)	Pelco
Sony EVI-D3x	Sony
VT VPT-4x	VT
AD SpeedDome	AD
SungJin SJ372R1	SungJin
Samsung SCC641	Samsung Electronics
Panasonic WV-CS850	Panasonic
SDZ160/330, Samsung SPD, Keyboard SCC3000A, Samsung SRX-100B	Samsung Techwin
LG GAC-PT2	LG
Merit-Lilin FastDome	Merit
Elmo PTC200C	Elmo
Canon VC-C4	Canon
HTC-2305	DongYang Unitech
RVision	RVision
Elbex	Elbex
Honeywell 755/655, HRX-2000, HTX-3000, ScanDome2	Honeywell
VIDO	VIDO
VICON	Vicon
Hunt	Hunt
ORX-1000	Sysmenia
Fine CRR-1600	LiveEye
Tokina	Tokina
Kodicom KRE	Kodicom
Nuvico	Nuvico

7. Playback/Search

7.1. Playback/Search Mode

7.1.1. Playback on Standard monitor (16 / 9 / 4 division)

- Please press the [SEARCH] button in monitoring mode or click the [SEARCH] button in the Function menu with the mouse.
- When pressing the [PLAY] button or the [FWD] button, the video plays in forward direction at 1× speed.
- When pressing the [REW] button, the video plays backwards at 1× speed.
- When pressing the Playback button in a multi-division monitor mode, it plays the recorded data for all viewable channels.

7.1.2. Playback function

PLAY ◀ ▶ :

Playback 1× speed Multichannel video will play when pressing the [PLAY] button in Multichannel monitor mode.

PAUSE II :

Pause the video temporarily.

STOP ■:

Stops the Playback and the DVR returns to live view.

FWD ▶ ▶ :

Playback speed will be changed (x1, x2, x4, x8, x16, x32, x64, x1/2, x1, x2, x4 – in order). When pressing the [FWD] button in live view mode, the DVR plays back the recorded video from 1 minute ago. Playback speed can be changed by pressing the [FWD] button.

REW ◀ ◀ :

Reverse playback speed will be changed (x1, x2, x4, x8, x16, x32, x64, x1/2, x1, x2, x4 - in order). When pushing the [REW] button in the live view mode, the DVR plays back the video from 1 minute ago. Playback speed can be changed by pressing the [REW] button.

1/2 FORWARD :

Plays at half speed in forward direction.

Jog Dial:

The Jog Dial can be used to control the video playback. The outer wheel controls the speed of the playback. The inner wheel can be used to control the Fast-forward function and the Rewind function.

7.1.3. Screen composition/names of the functions:

Screen composition

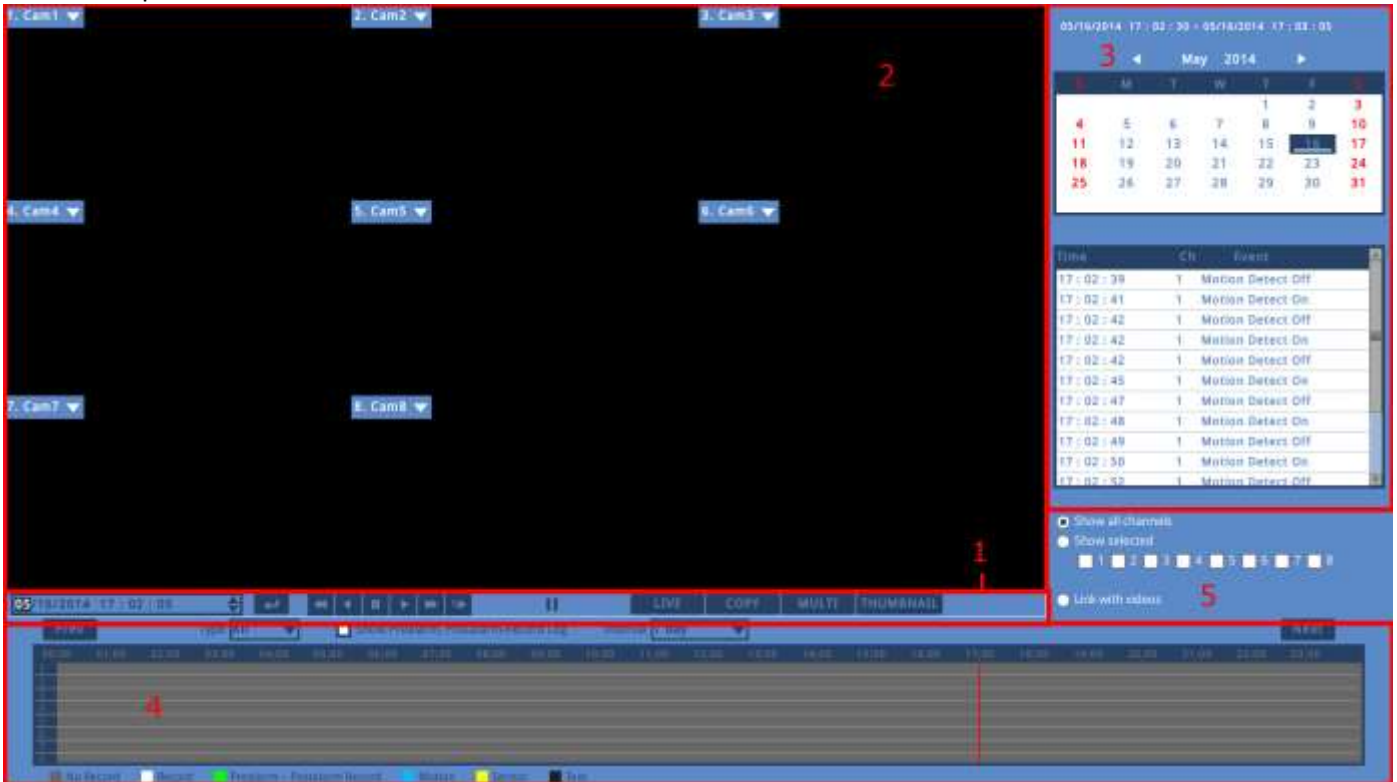

Name	Description	
1	Playback button	Use the buttons to control the playback.
2	Screen	Displays the playback videos.
3	Log viewer	Displays the log seen on timeline
	Calendar/time search	Select a date on the calendar to view the data of the date.
4	Timeline	Displays the info of the unit and search the playback sections.
5	Channel Selector	Allows you to select the channels that will be displayed

Icon function description:

Buttons	Description
	Go back to live mode.
	Enter COPY menu
	Select multi-screen mode.
	Switches to Thumbnail Search Mode
	Fast Rewind button
	1x reverse playback button.
	Pauses the playback.
	1x forward playback button.
	Fast Forward button.
	1/2 forward playback button

Time search:

Enter the date and time you want to search and press enter to move to the entered date and time.



Calendar search:

When calendar search is running, it marks the dates on which there were recordings.

Select a date from calendar you want to search, and it moves to the desired date.



Event search:

Event info(All, Motion, Sensor, Text, None) is shown on the timeline. Select a list to move to the selected time.

Time	Ch	Event
17 : 02 : 39	1	Motion Detect Off
17 : 02 : 41	1	Motion Detect On
17 : 02 : 42	1	Motion Detect Off
17 : 02 : 42	1	Motion Detect On
17 : 02 : 42	1	Motion Detect Off
17 : 02 : 45	1	Motion Detect On
17 : 02 : 47	1	Motion Detect Off
17 : 02 : 48	1	Motion Detect On
17 : 02 : 49	1	Motion Detect Off
17 : 02 : 50	1	Motion Detect On
17 : 02 : 52	1	Motion Detect Off

Channel Selector:

Select between all channels or a selection to be displayed in the monitor and timeline.



7.2. Copy

The Copy function is used to back up video material on USB devices or CD/DVDs. For USB devices you can select between the EXE (multichannel) and AVI (only 1 channel) video format and store it on a FAT32 formatted device. In the user authorisation you can define which user has the right to back up the video. For this please refer to chapter 8.1.3. User Setup.

To use the copy function, press [COPY] or click the Copy button in the Function menu.

NOTE: The multi-channel format always includes a miniplayer.exe file that can play back the video without the need to install any program. You have also access to the logfile with this miniplayer.

NOTE: When accessing the Copy function from Playback, the actual playback time will be copied to the Start time field and the Stop time field will be 1 minute later. With these settings an easy adjustment of the backup time is possible.

7.3.1. CD/DVD

This is the copy function if you use a recordable CD or a DVD. Please insert the recordable CD or DVD first before you start the backup menu. The CD or DVD will be automatically detected.

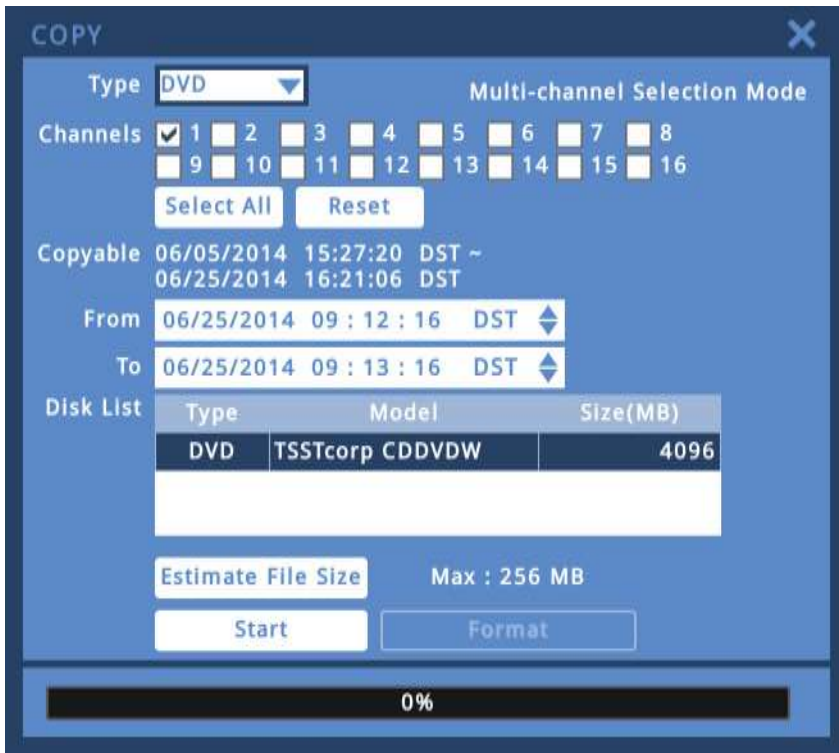

Type:

Select CD/DVD by using the direction keys or the mouse.

Channel:

Select the channels you want to back up.

From:

Select the start date and time to copy using the Up / Down direction keys or the mouse.

To:

Select the end date and time to copy using the Up / Down direction keys or the mouse.

Select Disk:

Select the media to copy using the [Enter] button on Select Disk.

Start:

Starts to copy. Press the [Start] button with [Enter] or click with the left button of the mouse.

DVD-R manufacturer (DVD+R is not supported):

- Mitsubishi (×16 recommended)
- TDK (×16 recommended)
- Imation (×16 recommended)
- Sony (×16 recommended)

7.3.2. EXE

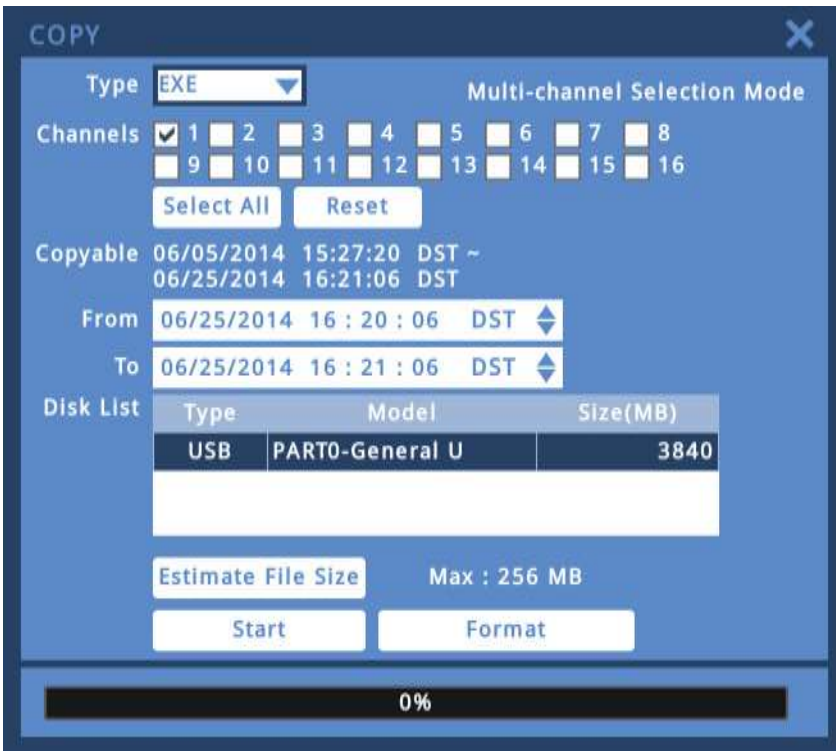

The EXE format can be backed up on external HDDs and USB Flash drives. Together with the video a Mini player will be copied to the Storage device to be able to view the EXE format. You can also open the EXE file with the GRUNDIG Control Center.

Select the channel you want to record and press [Enter] or use the mouse to open the channel selector as shown below.

Type:

Select EXE using the direction keys or the mouse.

Channel:

Select the channels you want to back up.

From:

Set the start date or time to copy. Use the direction keys or the mouse to change the values.

To:

Set the end date or time to copy. Use the direction keys or the mouse to change the values.

Select disk:

Select the media you want to copy to. Press [Enter] on the Disk list or click the mouse.

Start:

Starts the backup. Press [Enter] or click the mouse.

Format:

This will format the entered USB device. All data on the device will be deleted.

NOTE: If the backup is interrupted, the backup files will not be playable on a PC.

7.3.3. AVI

In the AVI format the user can back up a single channel video. Together with the video file the System and Event log of the selected time frame will be copied to the external storage.



Type:

Select AVI using the direction keys or the mouse.

Channel:

Select the channel to copy with the direction keys or the mouse.

From:

Set the start date and time you want to back up. Use the direction keys or the mouse to change the values.

To:

Set the end date or time to copy. Use the direction keys or the mouse to change the values

Select disk:

Select the media on which you want to back up the AVI file. Press [Enter] and select the media or click the mouse.

Start:

Starts the backup. Press [Enter] or click the mouse.

Format:

This will format the entered USB device. All data on the device will be deleted.

8. Configuration

8.1. System Setup

Time, Disk and Authority settings and miscellaneous settings can be configured here.

8.1.1. Date/Time

The Date and Time setting should be configured prior to any recording.

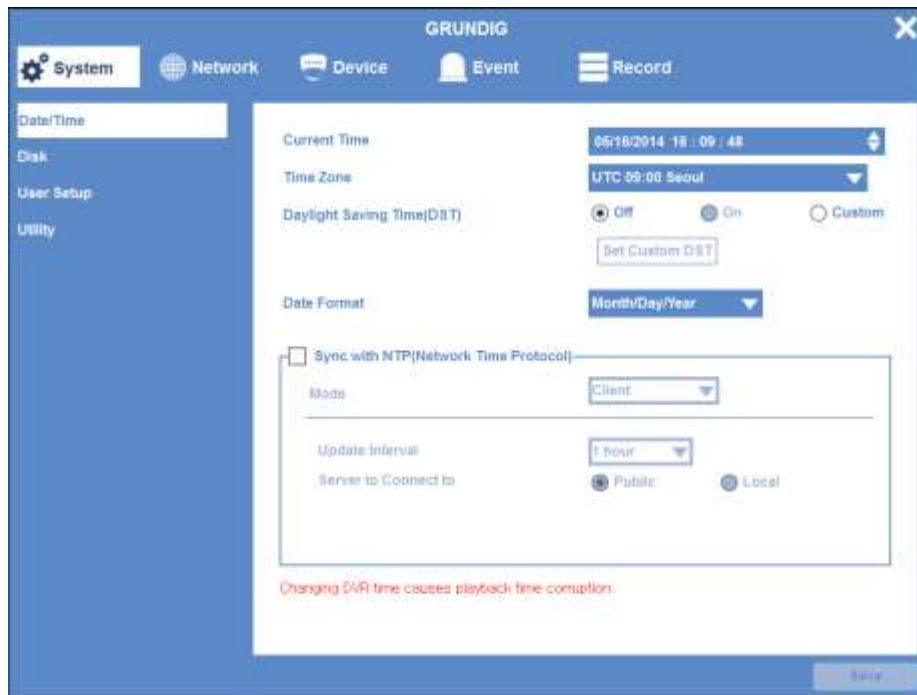

The Time configuration is very important to protect the recording data. Changing the time during recording is not recommended. The factory default setting for the time is “UTC 00:00 Dublin”.

Time Setup:

Caution: While recording, changing the system time will affect a time change for all previously recorded video data. Therefore, we recommend to back up the recorded video before changing the system time.

- Press “Main Menu” in the Function menu or the [MENU] button on the front panel.
- Select the “System” menu.
- Select “Date/Time” in the System menu. The Date/Time configuration will be opened.
- Use the directional keys or the mouse to change the values.

Time Zone / Standard Time:

Use the Left / Right direction keys or the mouse wheel. To return to the previous menu, press [ESC] or click the right mouse button.

Daylight Saving:

This menu is synchronised with the time zone configuration menu. When a daylight saving area is set, this function is activated. The daylight saving applicable area is working in conformity with the time zone of Microsoft Windows.

Custom DST Setup:

You can also use a custom DST. Select a fixed day of a week (first Tuesday of March) or the day of a month (24th of March) to select when the switch should happen. You can also define the exact time, when it should happen. This can be used if you want to change the time not in the middle of the night, but maybe on the noon of the next day, so you have enough time to search for any events using the “old” time, for example.

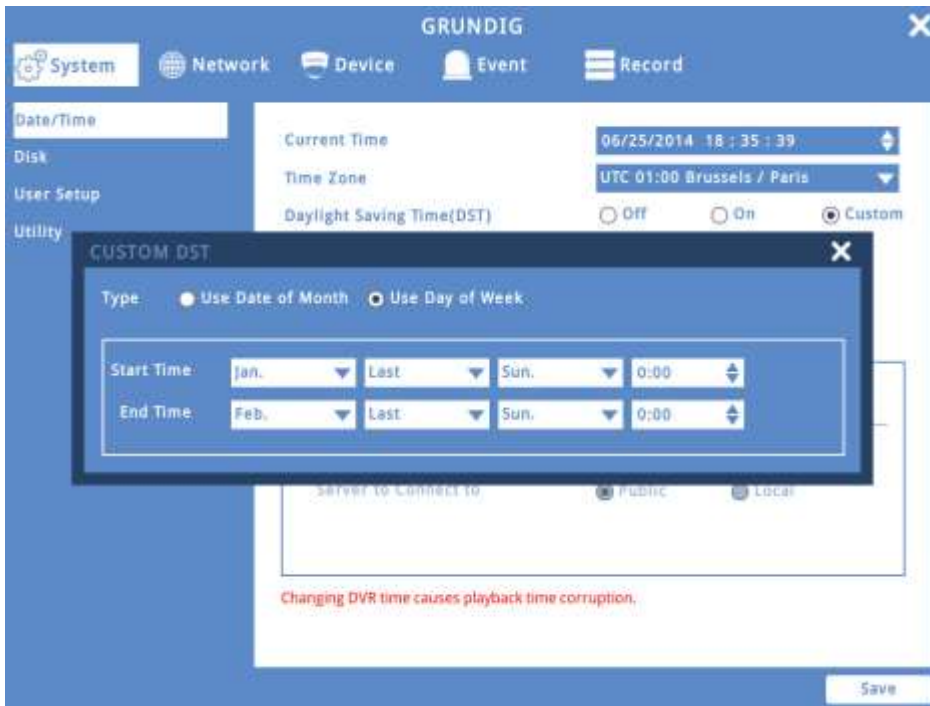

Date format (Type):

Change the date format between “MM/DD/YYYY”, “YYYY/MM/DD” and “DD/MM/YYYY” by using the Left / Right direction keys or the mouse wheel.

Start / End Time:

With the Left / Right direction keys, you can move to year, month, day, hour in order. Each configuration can be changed with the Up / Down direction keys or the mouse wheel.

NTP Setup / Set Automatically (NTP):

The NTP (Network Time Protocol) synchronises the time of all connected devices. The DVR can be set to client mode or server mode or to both modes at the same time.

Sync with NTP:

Enable or disable the NTP function.

NTP Mode:

Configure the NTP mode of the DVR – Client / Server / Both

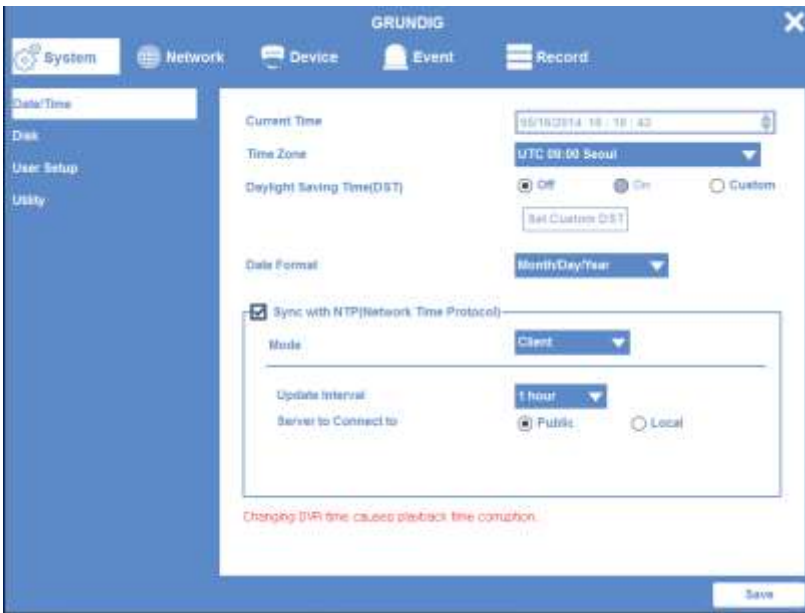

NOTE:

When using the NTP client mode, the user must set the NTP to "On". NTP Server Loc.:
 If the DVR is in client NTP mode, this function is enabled. Configure the IP address of a local network NTP server or select "Public" if the NTP server is a public one.

NTP Local server IP:

Input the IP address of the local NTP server or a DVR that is working in NTP server mode.

Interval:

Configure the interval of the time synchronisation.

8.1.2. Disk

In the "Disk" menu everything regarding the hard disk of the DVR can be configured. Here you can also use the Disk Manager to format HDDs.

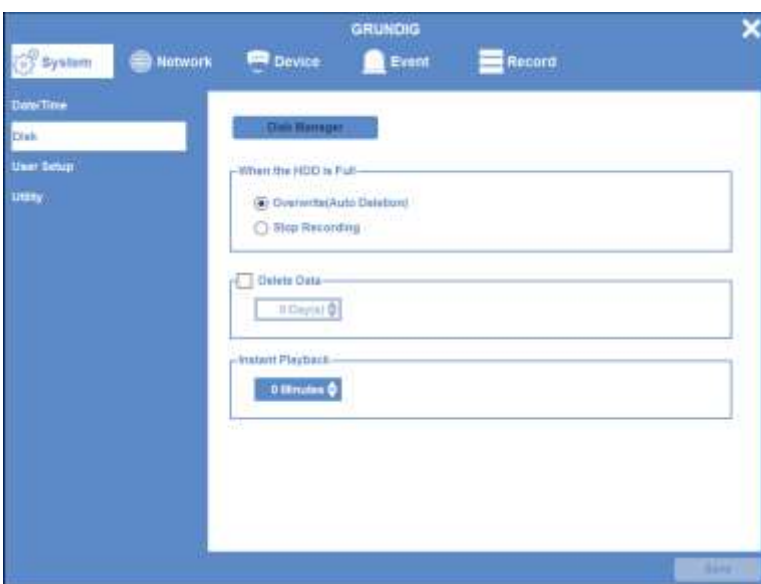

Overwrite (Auto Deletion):

If there is no space left in the HDD, old data will be overwritten automatically.

Delete Data:

Select this ticker to select after which amount of days the recorded data will be deleted.

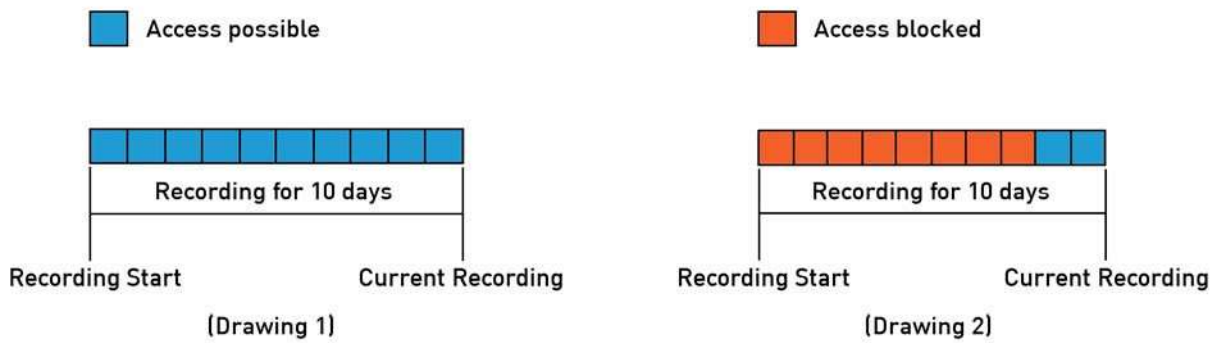

Instant Playback:

Decide the time interval that will be used to go back in time when you select the instant playback function.

Disk Manager:

“Disk Manager” is the menu for the management of internal or external HDDs (hard disk drives). You can see the type, name, the bad block status and the size of the HDD in this menu. You can also select if the HDD is enabled for recording or not.

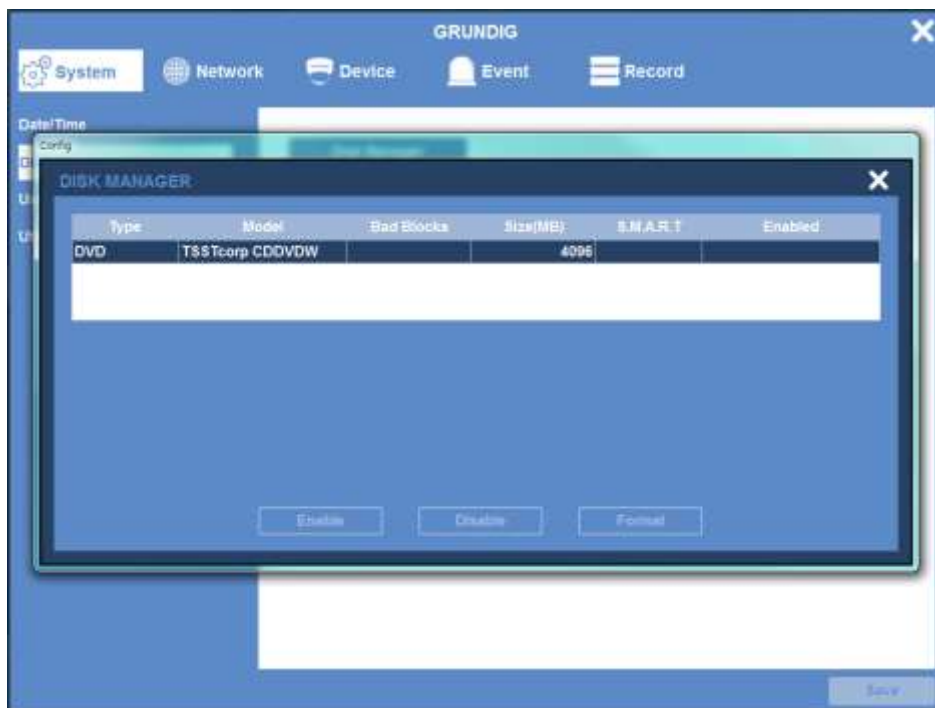

NOTE: If you enable a HDD to record, you will be asked whether the HDD should be formatted. Type: Displays the location or type of disk (Int A (Internal A HDD), Int B (Internal B HDD), Ext (External HDD)).

Model:

HDD model name

Bad Blk:

Displays the number of bad blocks of the HDD.

Size:

Displays the HDD size in MB.

Enabled:

Shows if a HDD is enabled for recording (“Yes”: Enabled / “No”: Disabled).

To enable a HDD, select it and change and press the [Enable] button on the bottom of the disk manager. If the HDD needs to be formatted, select [Format] first. All data will be erased then.

8.1.3. User Setup

The user setup is only editable for the administrator. Users can only change their passwords here.

In the user setup you can define which user has which rights. You can choose that users are only allowed to access defined channels and can only execute defined functions. Here you can change the user name and the password.

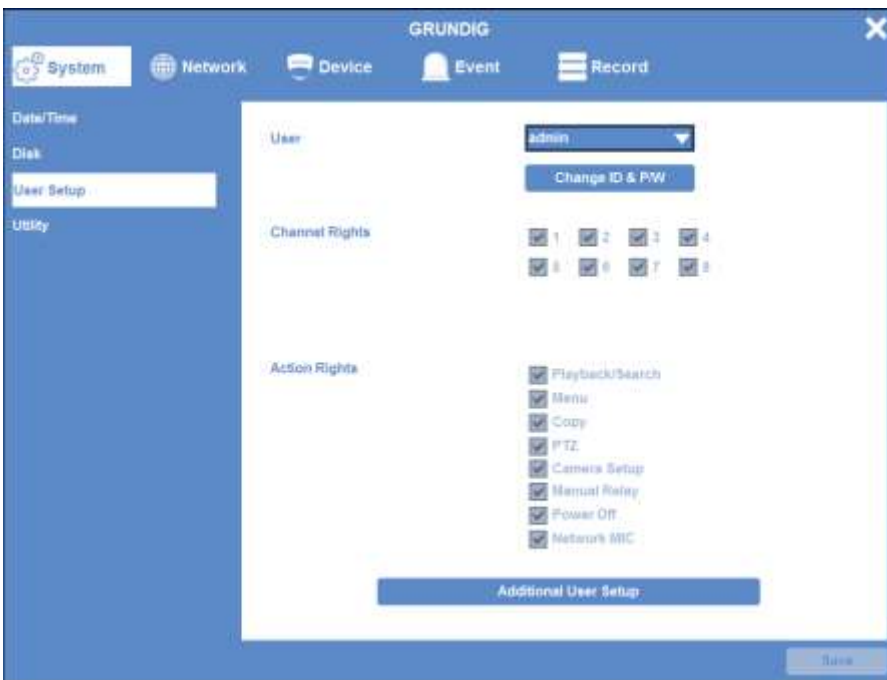
**User :**

Here you can select which user you want to edit.

Change ID & Password:

Change the user name here. This name can then be used to enter the DVR directly or over the Ethernet connection.

Change Password:

The password can be up to 8 digits long. To ensure you did not misspell the password, you have to enter the password twice. Press “Change” when the password is finished. After that, a message window will be shown and you have to confirm the password change.

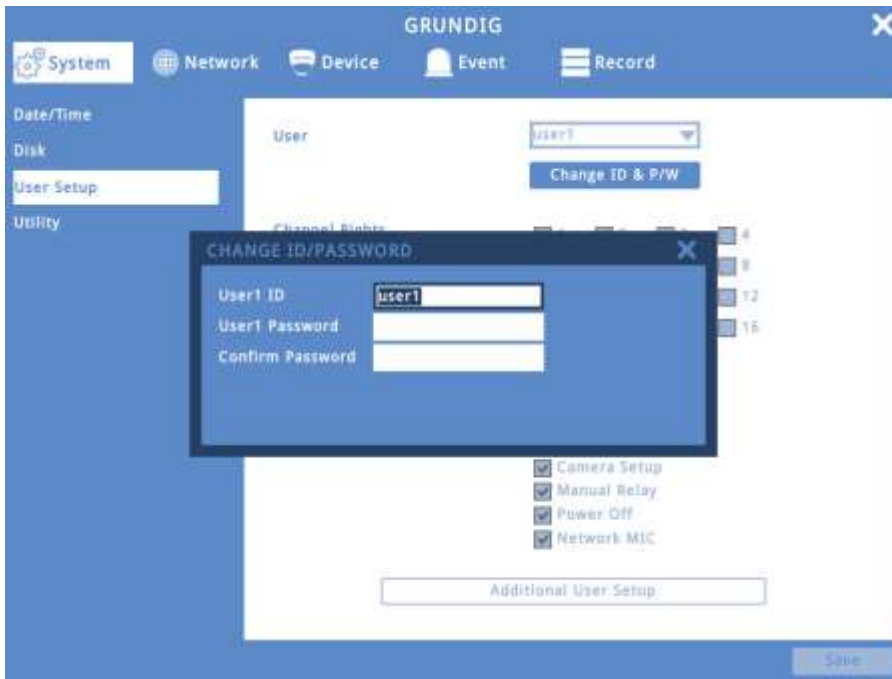

NOTE: The Admin Password is “1234” in factory default. For user 1 to 10 the password is (in order) “1111”, “2222”, ... and for user 10 it is “0000”.

Access rights:

Here you define which rights the user has. The administrator has always all of the rights and this cannot be changed. In the default settings the users do not have any right to see any channel or do anything. The administrator needs to give them rights first.

Action rights:

Here you can define which functions of the DVR the user can access.

Action Rights

- Playback/Search
- Menu
- Copy
- PTZ
- Camera Setup
- Manual Relay
- Power Off
- Network MIC

Menu: Gives the user the right to access the configuration menu. (The users are not allowed to change the user rights or to perform a factory reset.)

PTZ: If set to YES, the user has the right to control PTZ cameras.

Relay: If set to YES, the user has the right to activate the relays of the DVR. **Playback:** If set to YES, the user has the right to access the Playback.

Power Off: If set to YES, the user has the right to turn off the DVR.

Copy: If set to YES the user has the right to backup video.

N/MIC: If set to YES, the user has the right to use the microphone function over the network.

Channel rights:

Here you can define which channels the user can see under Live & Playback. Covert channels will also be invisible in search results and backup files.

Channel Rights

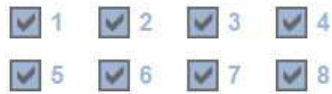

Additional User Setup:

In the Additional User Setup extended functions can be accessed.

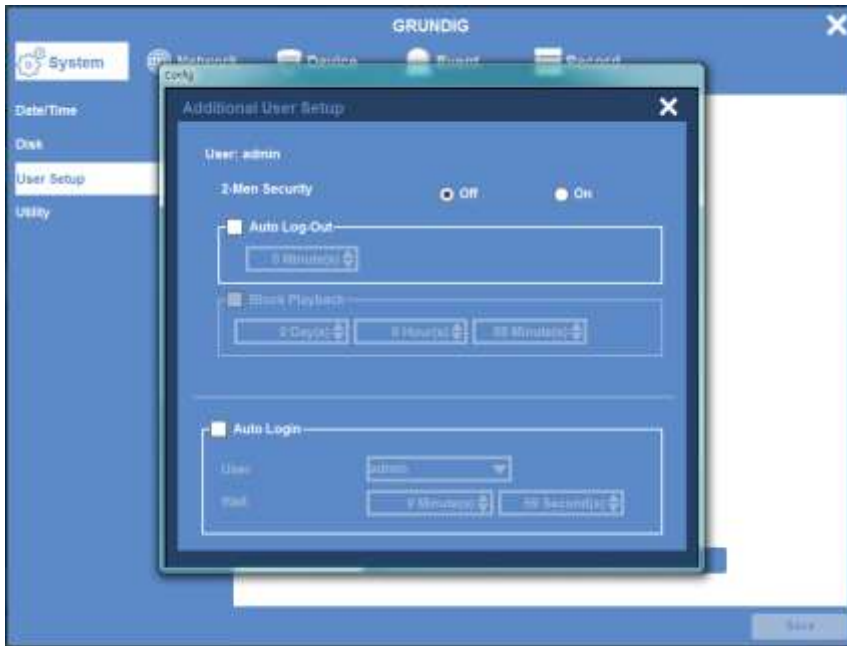

2-Men Security:

Activate this function to enable the 2-men security function for this user. You will need to enter a second password for this user to log in.

Auto Log-out (Min):

Every user can have its own auto-log-out time. With this function you can, for example, limit the admin access to 2 minutes. So even if you forget to log-out, the access to the DVR will not be possible without the admin password. But you can also create a user with infinite log-out time (set to 0), so that you can have a "guest" account that will show defined channels all the time without any special function rights.

Block Playback:

Here you can block the playback access independently for each user. Select days, hours and minutes for the user he is allowed to access the recorded material.

NOTE: If a user is logged in locally with blocked playback access. Also from remote the playback time is blocked, even though the remote user, might have a different time range he can access.

Auto Login:

The Auto-Login function can be used to log in a user automatically. Use this function to restart the DVR in a guest mode, with limited access for example.

8.1.4. Utility

Configure the name of the DVR, the remote control ID and Language.

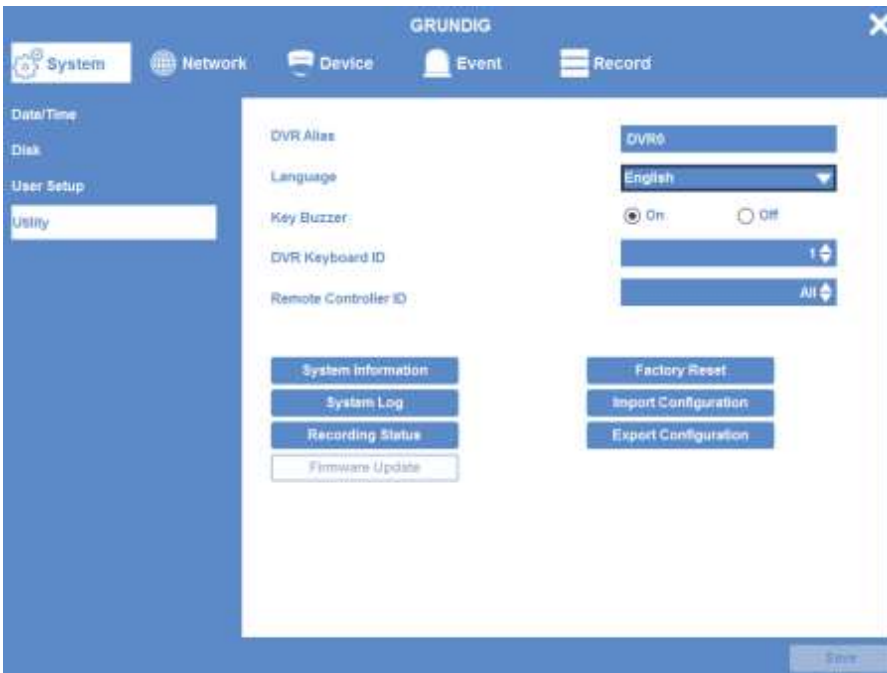

DVR Alias:

Set the name of the DVR. This name will be shown when accessing the DVR via a network.

Language:

Select the language you would like to use.

Key Buzzer:

Select if the Buzzer will be active, when you press a button on the front panel of the DVR.

DVR Keyboard ID:

This menu is for setting the address of the keyboard when using all functions of the DVR with the keyboard. Factory default is "1". If the user wants to control various DVRs with one keyboard, each address should be set with a different value.

Remote Controller ID:

Maximally 16 remote control IDs can be set. One remote control can be used to manage all the 16 DVRs.

Registration order for the remote control:

1. Make the remote control point in the direction of the DVR.
2. Press the ID button several times to match the ID of the remote control to the DVR.
3. If the IDs are matched correctly, the DVR buzzes.
4. Now you can use the remote control.

System Information:

The System information contains all the relevant system information like firmware and model type.

System Log:

The system log shows the boot status of the system and any changes regarding users and the DVR configuration.

You can also export the system log to USB disk from here.

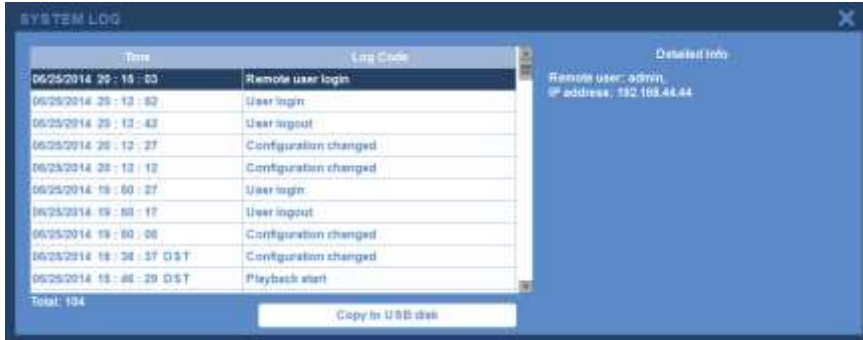

Firmware Update:

You can update the firmware by a USB Memory device.

- Insert a USB memory device including the firmware file to the USB port.
- Press the Firmware Update button.
- Select [YES] in the pop-up window.

NOTE: Only the administrator is allowed to perform a Firmware Update.

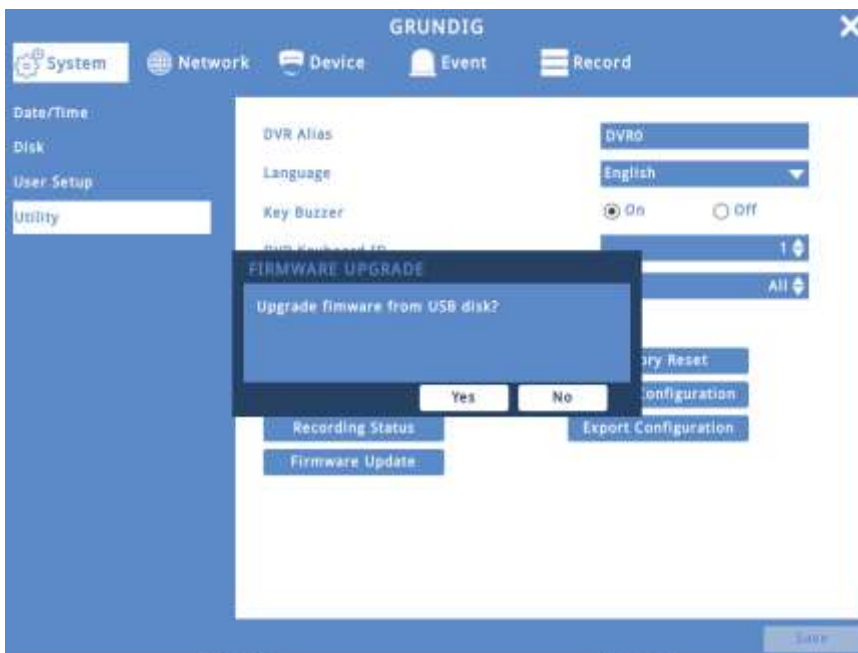

- The system will reboot.
- Firmware update is done.

Factory Reset:

Set all configurations back to factory default.

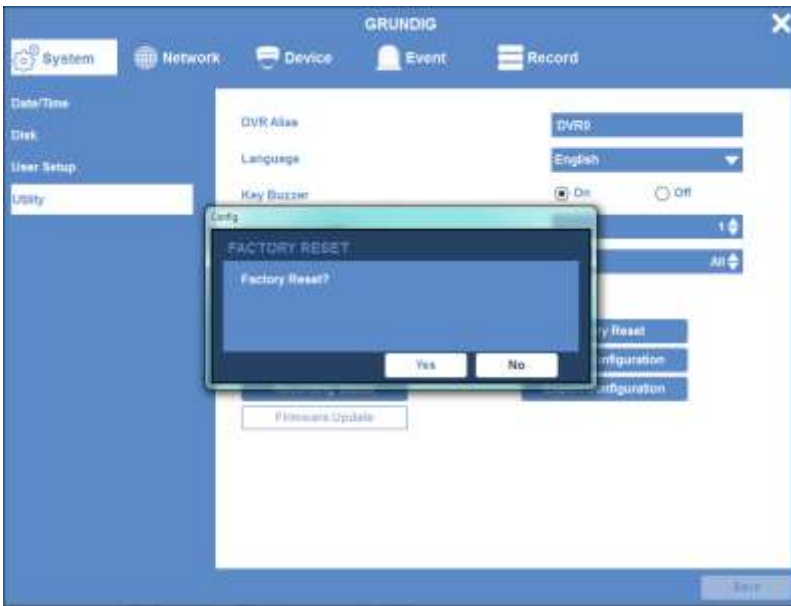

NOTE: Only the administrator is allowed to perform a factory reset.

Import/Export Configuration:

Use this function to backup the DVR configuration for a later time, or to copy it to other DVRs of the same model type and firmware status.



8.2. Network

This is the menu for configuring the network related settings.

8.2.1. Network



Type:

Configure the type of Network (Ethernet/xDSL) connection. If the DVR is connected to a local network, you can change the configuration directly in the fields below. If the DVR is connected by xDSL (PPPoE), please make the configuration in the xDSL submenu.

Automatic Addressing (DHCP):

With DHCP (Dynamic Host Configuration Protocol), all hosts connected to LAN can get a temporary IP address from a DHCP server.

If the LAN has an active DHCP server, this server allocates the IP address directly to the DVR. If there is no DHCP server in the network, the IP address needs to be configured manually.

IP Address:

The IP Address is for connection between the DVR and the Control Center and also for the web connection with the WebViewer (Net Mask and Gateway need to be configured if you want to access the DVR over the Internet.)

Net Mask:

The Net Mask determines the range of the IP addresses which are available for use. You should receive the correct data from the network administrator.

Gateway:

The Gateway is necessary for different types of network connections. You should receive the correct data from the network administrator.

UPnP (Universal Plug and play) Port Forwarding:

This very helpful feature can be used if you do not want to configure your network forwarding ports manually. If activated, the DVR will instruct your router automatically to forward all requests coming to the defined port. Set the Port Forwarding to "On" to activate this feature in the Pop Up Window. The status of the UPnP forwarding will be shown in the Status field.



DNS Server:

DNS is a network service used to rename IP addresses (Domain Name Server) and it should be received from the network administrator.

Port:

The port is necessary for the connection to the Control Center Software and the WebViewer. The factory default setting is Port 80. If you want to connect to the DVR through the internet over a router, this is the port you will need to forward in your router.

Please make also sure that your firewall is not preventing the access to this port.

Bandwidth Limit:

In this menu the bandwidth used for video transmission can be limited. You can define the bandwidth between 0.03 Mbps and 99.99 Mbps. Contact the network administrator for further information on bandwidth limitation.

Video Streaming:

Adjust the RTSP streaming settings here. Choose the RTSP port and deactivate authentication if needed.

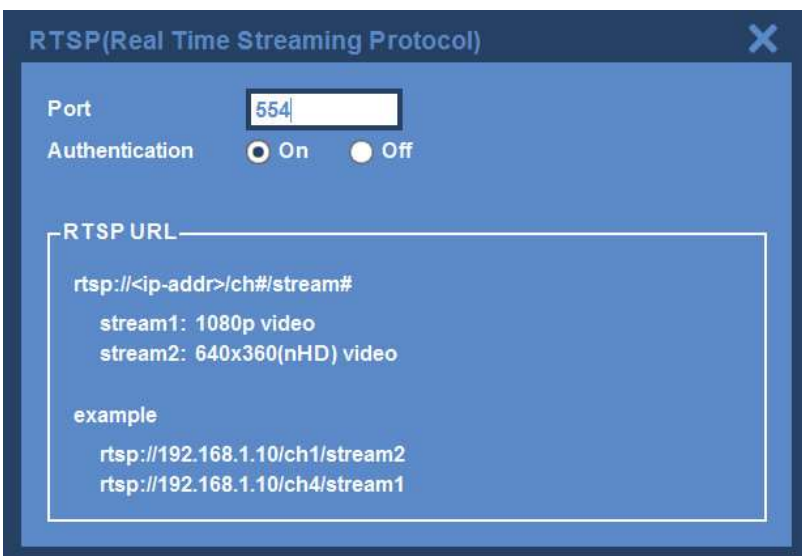

IP Filtering:

Configure a White- or Blacklist to filter IP addresses for remote connection.



8.2.2. DDNS

If the DVR is connected to a Cable modem or a xDSL modem, the IP address will be changed with every connection to ISP. To connect to the DVR over the Internet you need to know this IP address. GRUNDIG supplies a DDN Server that can be used to update the IP address of the DVR. The DVR sends its latest IP address to this server and the user can then connect to this server to access its DVR.

To register the Static IP to DDNS, please refer to the following configuration.

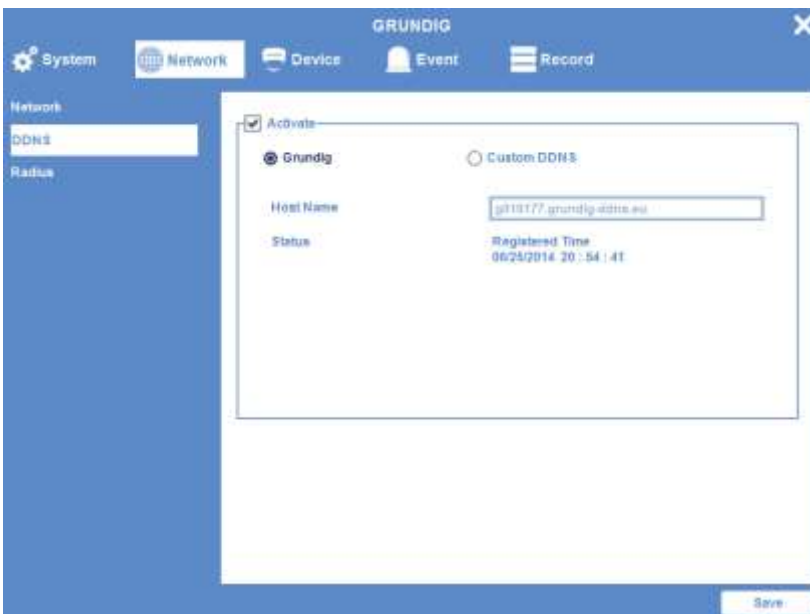

Host Name:

This menu shows the server address where the DVR registers its dynamic IP address. The DDNS address, on which GRUNDIG is operating now, is: www.grundig-ddns.eu.

You can access the DVR now over the internet and the Control Center Software through the following address: [last 6 digits of the MAC address].grundig-ddns.eu

(example: g02c362.grundig-ddns.eu)

Custom DDNS:

If you have already a DDNS service like no-ip.com, you can use this account also with your Grundig DVR. You have to enter your Host Name, user ID and the password to use this function.

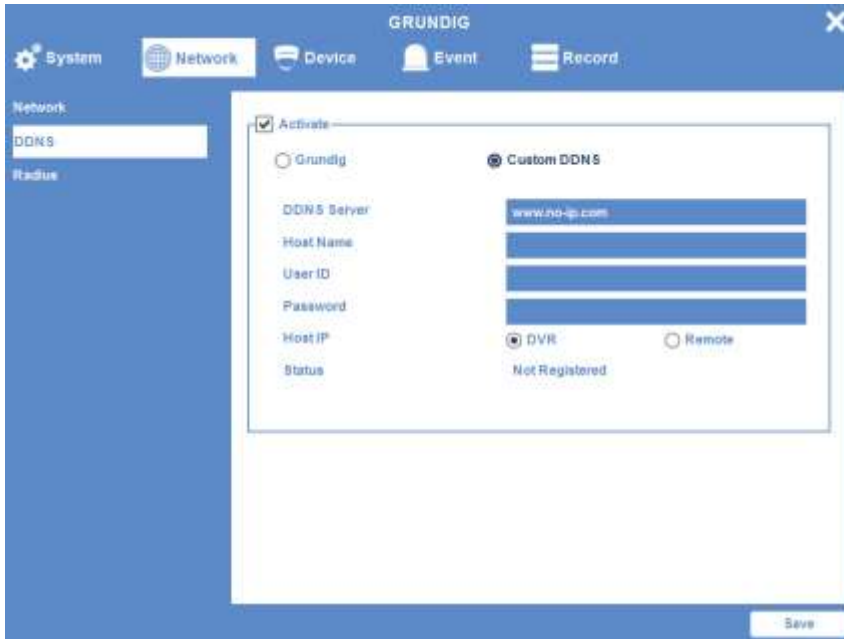

The MAC address is printed on the box label and on the backside of the DVR.

8.2.3. Radius

Remote Authentication Dial In User Service (RADIUS) is a networking protocol that provides centralized Authentication, Authorization, and Accounting (AAA) management for users that connect and use a network service.

Here you can configure the Radius settings if you are using this protocol in your network.

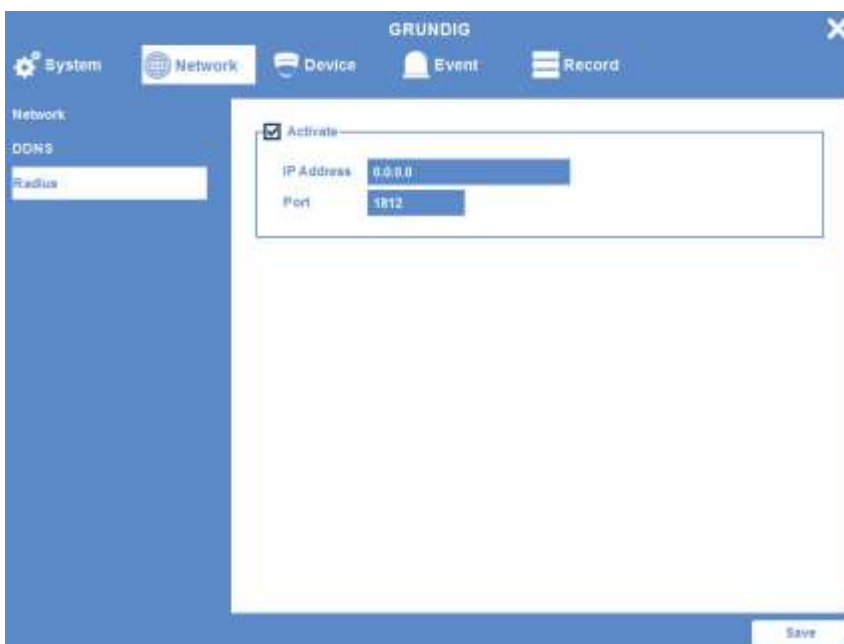

8.3. Device Setup

In this menu you can configure all devices that can be connected to the DVR, like cameras, monitors and keyboards.

Caution: NTSC and PAL cameras cannot be used at the same time.
If changing the camera type from NTSC to PAL, the system should be rebooted.

8.3.1. Camera Setup

Select the camera you want to configure, by selecting its channel.

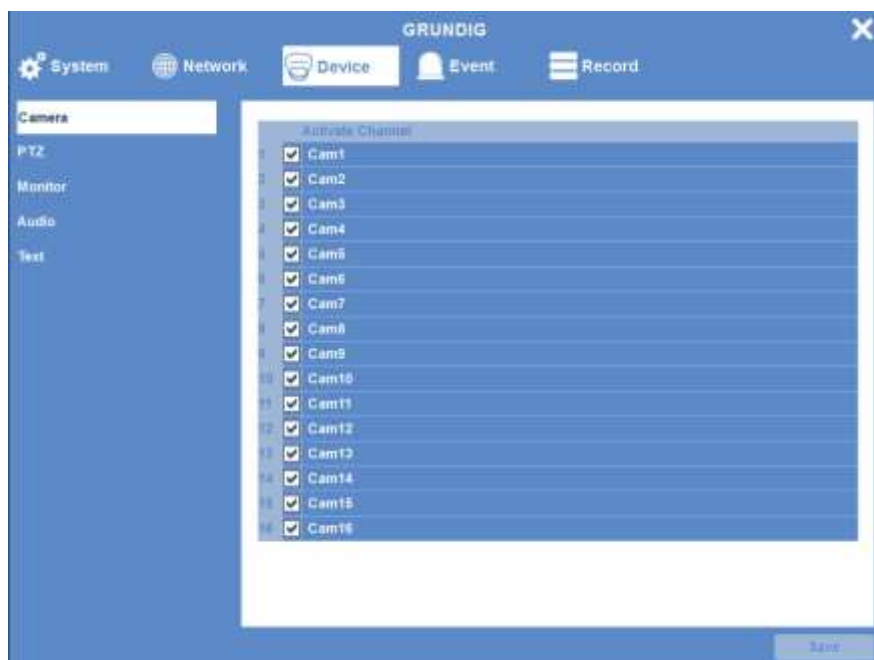

Name:

Fill in the name the camera should have. This name will be shown on the monitor and will be also shown in the GRUNDIG Control Center Software.

When pressing the [Enter] button or clicking the mouse, you can enter the camera name in the text menu.

8.3.2. Monitor Setup

Configure all connected monitors. Depending on the model of the DVR and the attached monitor different options are available.

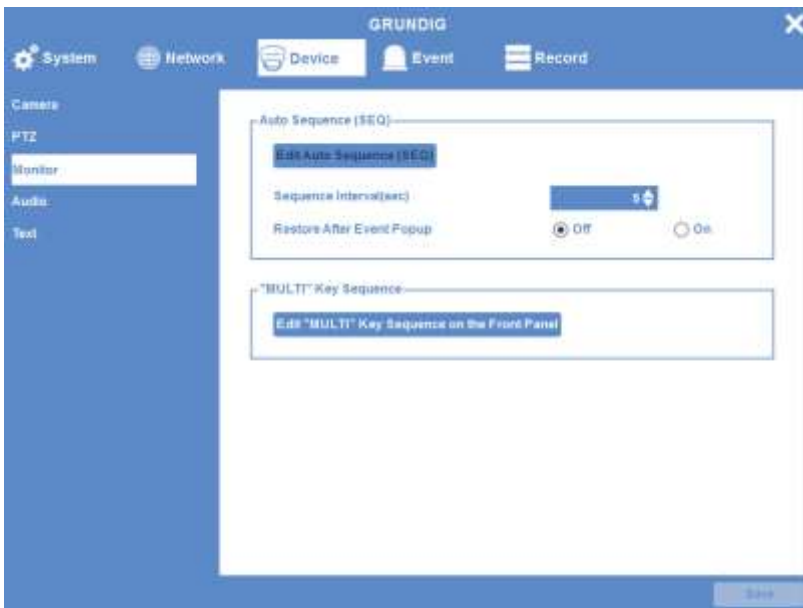

Sequence configuration:

Here you can configure the user sequence. You can edit up to 16 steps within an interval from 1 to 60 seconds. You can select a single channel and Multi-Mode views.



Sequence Interval:

Select the amount of time in seconds between the switching of channels during sequence.

8.3.3. Audio Setup

In this menu the user can configure Audio recording, Volume, Synchronisation and Mixing.

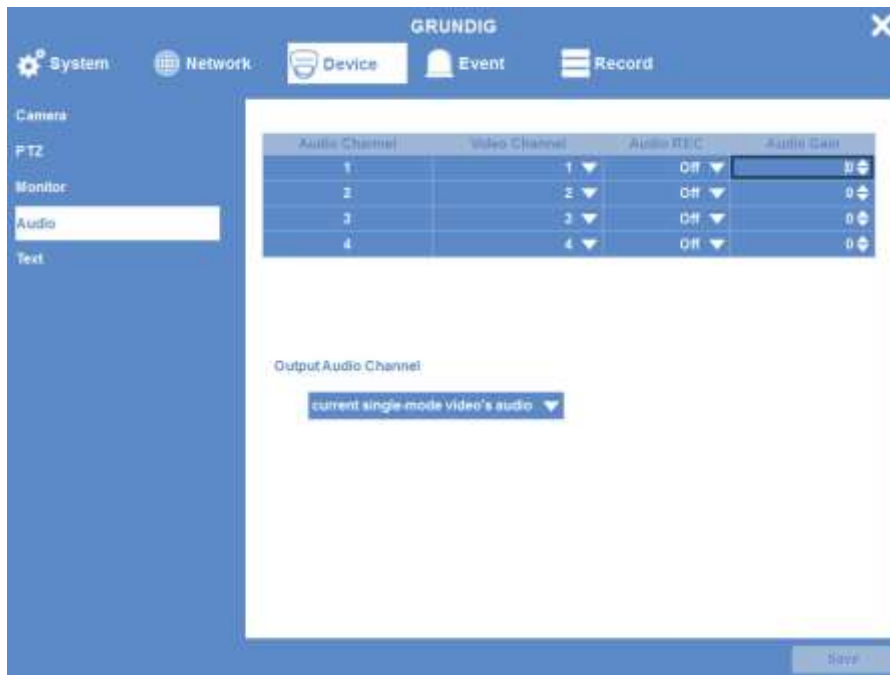

Audio Channel:

Select the channel you want to configure.

Video Channel:

Select the video channel you want to connect to this audio channel.

Audio REC:

Enable or disable the audio recording. If disabled, audio will be transmitted in live view, but will not be recorded. If audio recording is enabled, the recorded audio will also be available in playback mode.

Audio Gain:

Configure the volume of the audio in the + /- direction.

Audio Output Channel:

Select the channel that will be active over the speakers. You can either fix one audio channel, or let always make audio channel active that is connected to the current video channel.

8.3.4. Text Setup

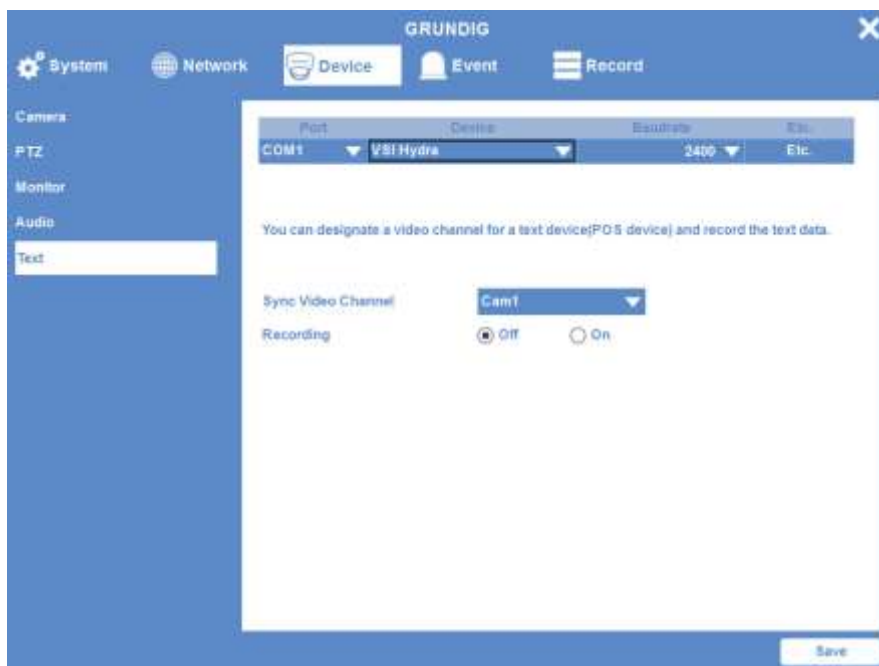

Device:

Select the type of the Text input device you are using. Choose between VSI-Pro Hydra, Starfinger 007 or manual configuration. If you choose the manual configuration you have to set the Header, Delimiter, Timeout and Lines settings.

Sync Video Channel:

Select the channel which will be synchronised with the text input.

Recording:

Enable or disable the recording of transmitted texts.

Seek Header:

Activate or deactivate searching for the header of the data. You can define up to 2 different headers here. For information about the header, please refer to the manual of your text input device.

Delimiter:

The delimiter value may differ depending on the device used. For more information on delimiters, refer to the user manual of the text input device.

Timeout:

The lines defined below are the maximum number of text lines available for one piece of data. Even though the number of lines is preset the actual number may differ sometimes. For example, three lines are programmed for a client name input for an ATM, but if someone registers only his/her first name and last name, only two lines will be provided when the person uses the ATM. The DVR will not be able to detect this automatically, so the Timeout function will be used to stop data recognition after the last line is entered.

Lines:

This defines the maximum number of lines for one piece of data.

NOTE: If the external text input device cannot be recognised, please contact the seller of the external device.

8.4. Event Setup

In this menu users can configure the handling of an event.

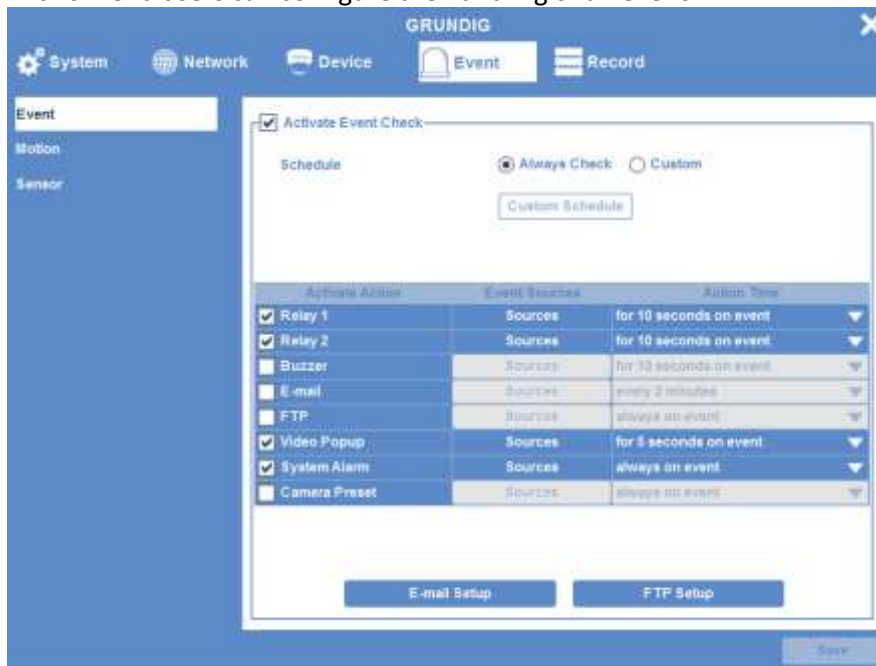

8.4.1. Event Check

Enable or disable the event checking algorithms. You can set up a schedule for the event check if you want to enable the event check only for a certain time frame. In the case of schedule mode, you can set up schedules for different dates and times, as shown in the following screenshot.



Create a schedule:

By default the DVR has set the event schedule for all days at all times. To edit the existing schedule, you have to delete the existing schedule first.

Then you can add new schedules by creating them in the Add Schedule field and press the [Add] button when you are finished. You can add schedules for each day or for weekdays and weekends.

8.4.2. Event Actions

Configure what action the DVR will perform if an event is detected.

Event Action:

There are different actions you can choose from: Relays, Buzzer, FTP, E-Mail, Video Pop Up, System Alarms and Camera Presets..

Action Duration:

Select how long an Action Duration will be kept up. Relay and Buzzer can be configured from 5 seconds to 60 seconds. In the FTP, E-mail and Twitter notification you can configure the repeating interval.

Event Sources:

There are multiple different event sources available that could trigger an event. The amount of these sources differ for each model, but they all have following types.

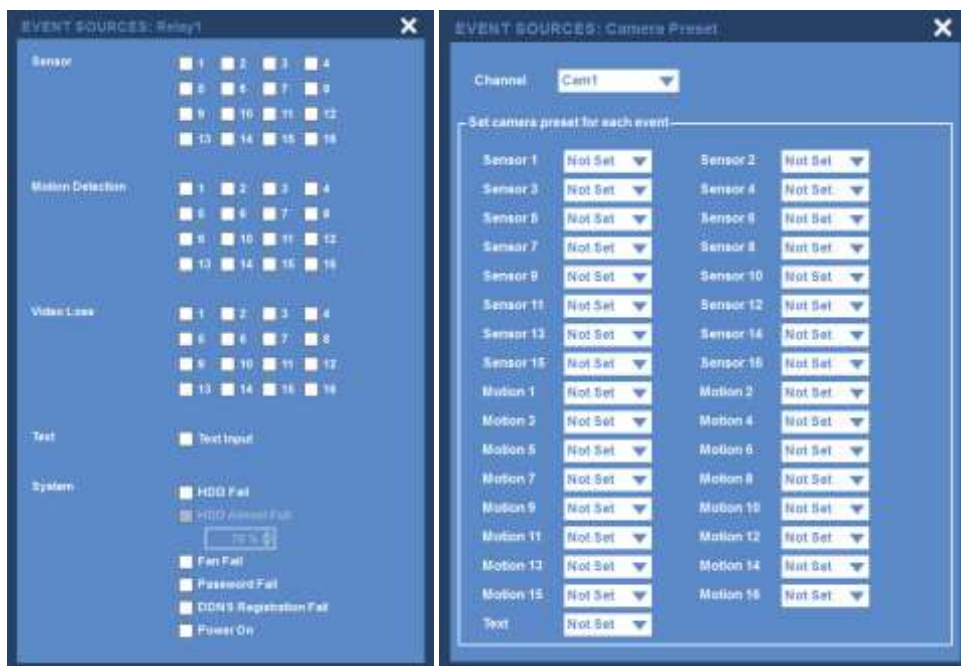

Sensor:

These will trigger an action when the physical contacts have been activated.

Motion Detection:

If the motion detection is set up, it can trigger event actions.

Video Loss:

If the connection to a camera signal is lost, it can trigger an action.

Text:

If you have set up the text device connection, the receiving of a text can trigger an event.

System:

Here system related events can be selected to trigger actions.

E-Mail Setup:

Here you can set up the sender & receiver E-mail address.



The screenshot shows a dialog box titled "E-MAIL SETUP" with a close button (X) in the top right corner. The fields are as follows:

- Recipient Address: receiver@gmail.com
- Sender Address: dvr1@dvr.com
- Attach Picture:
- SMTP Server section (indicated by a bracket on the left):
 - Address: SMTP_SERVER
 - ID: email_jd
 - Password: [masked]
 - Port: 25 (dropdown menu)
 - Authentication: Not Use (dropdown menu)
- Send Test-Mail button at the bottom.

Recipient Address:

Input the E-mail address to get an event alarm to this E-Mail address.

Sender Address:

Not mandatory, but necessary if the receiver wants to know which DVR sent the event.

Attach Picture:

Tick this box, if you want to receive a picture of the channel that triggered the event.

SMTP Server:

Address: Enter your SMTP server address, provided by your email address provider.

ID: Enter the username for your email address.

Password: Enter your email password.

SMTP Port: Enter the port your SMTP server is using. This information can also be obtained from your email provider.

Authentication:

Please select here if your SMTP Server needs an authentication. You can also choose if your SMTP Server is using a TLS encryption method.

FTP Setup:

Here you can set up all information needed to upload events to an FTP server.



The screenshot shows a dialog box titled "FTP SETUP" with a close button (X) in the top right corner. The fields are as follows:

- Sever IP/URL: FTP_SERVER
- FTP Directory: /
- User Account section (indicated by a bracket on the left):
 - ID: ftp_user
 - Password: [masked]

Server IP/URL:

Input the URL to connect to the FTP server. Please use either a DNS name or the static IP address.

FTP directory:

If you want to include all the uploads in a dedicated directory please name it here. Make sure the directory exists on the FTP server.

User ID:

Please input the user name which will be used to access the FTP server.

Password:

Please input the password of the above user.

8.4.3. Motion Detection

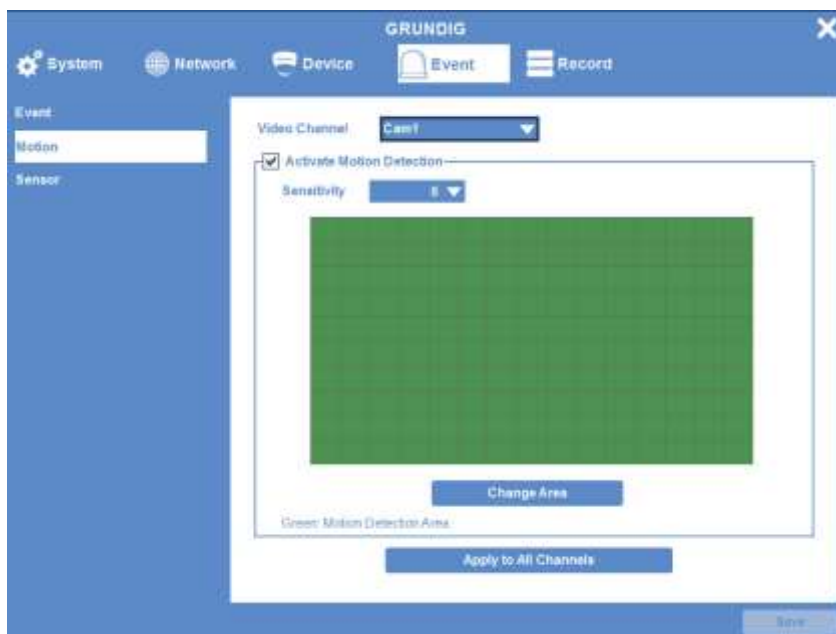
**Video Channel:**

Select if you want to configure all channels or only a dedicated one.

Sensitivity:

The sensitivity of the motion detection can be configured from min. 1 to max. 10, whereas 1 means less sensitive and 10 means very sensitive.

Change Area:

A custom area can only be defined for a single channel. The video is divided into 15x10 grids. After pushing the custom area button, the configuration window for the detection area will appear.

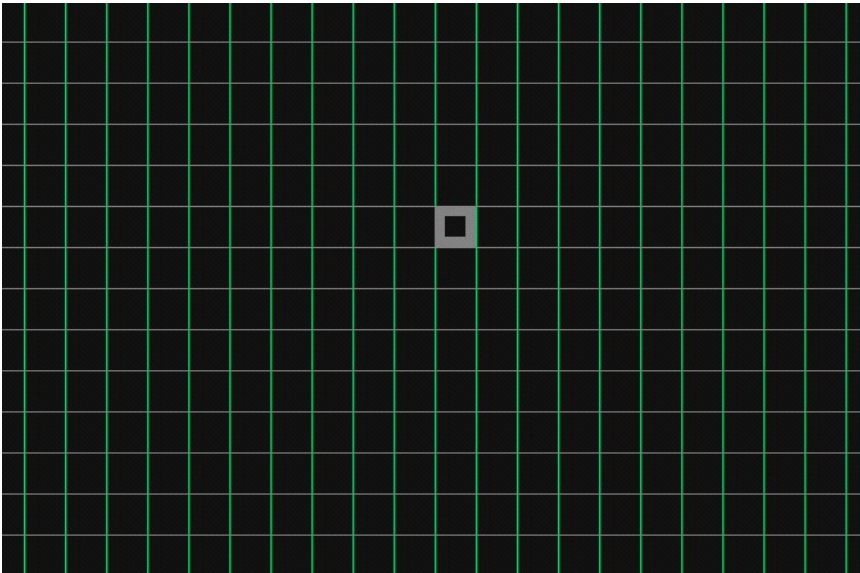

Select an area with the direction keys and press [Enter] or click the mouse to select or deselect an area which is used for motion detection. The first selected field will define the start and the second one will draw a rectangle within these 2 fields. Combine several rectangles to optimise the Motion detection area. Press the [ESC] button or click the right mouse button to apply your settings and go back to the previous menu.

8.4.4. Sensor

This menu is to set up the existing sensor input and the type of the sensor. GRH-K4116B has 16 inputs, GRH-K2108B has 8 inputs and GRH-K1104B has 4 inputs. The sensors can be set either to Normal Open (N.O.) or to Normal Close (N.C.).



8.5. Recording Setup

There are 3 modes for recording – Continuous Recording, Manual Recording & Schedule Recording.



Schedule Recording records according to a configured schedule, you can use different programs for different times.. Manual Recording records only after pushing the [REC] button or an event is noticed, continuous recording will record all the time and can switch the recording mode when events are detected.

8.5.1. Continuous / Manual / Schedule Recording Setup

Continuous Record:

If the DVR is set to Continuous Record the DVR will record all the time. If an event occurs the recording setting will be changed from continuous to event settings.

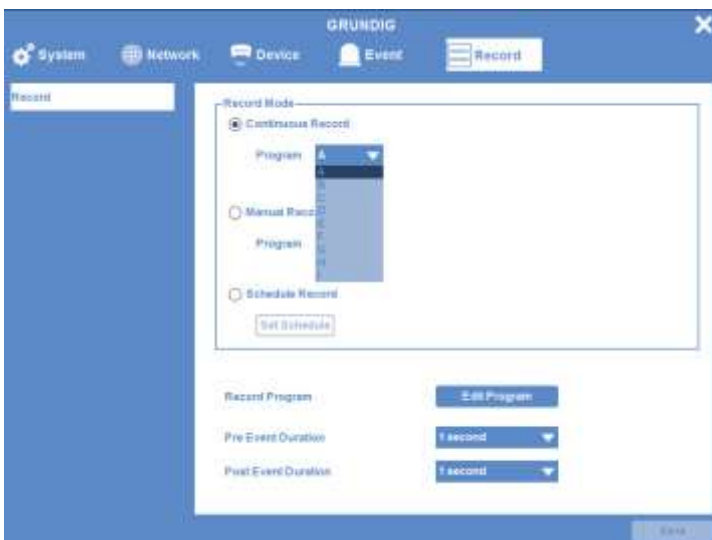

Manual Record:

If set to Manual Record, the DVR will record when pressing the [REC] button. It will stop recording when you press [REC] again. If an event is detected the DVR will start recording automatically. You can also set which program is used for manual recordings.

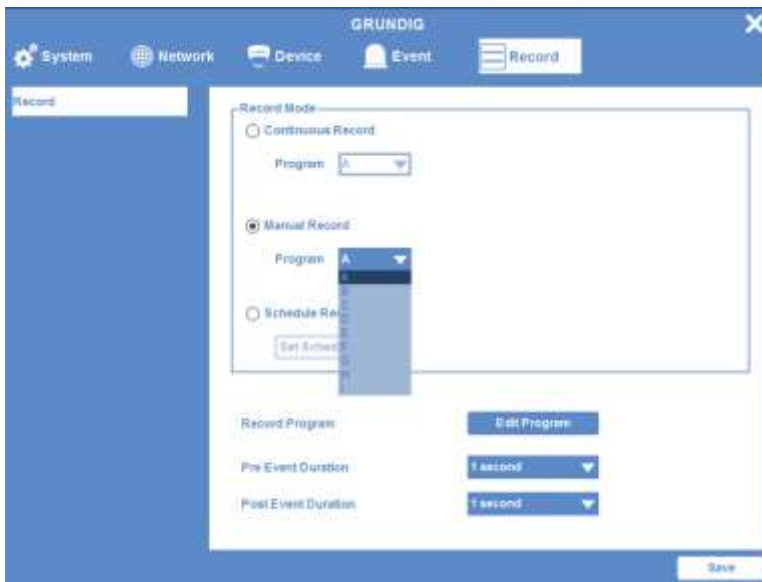

Schedule Record:

The DVR can record automatically, depending on the programmed schedule. Set the recording mode to Schedule Record and configure the days and time in the schedule submenu.

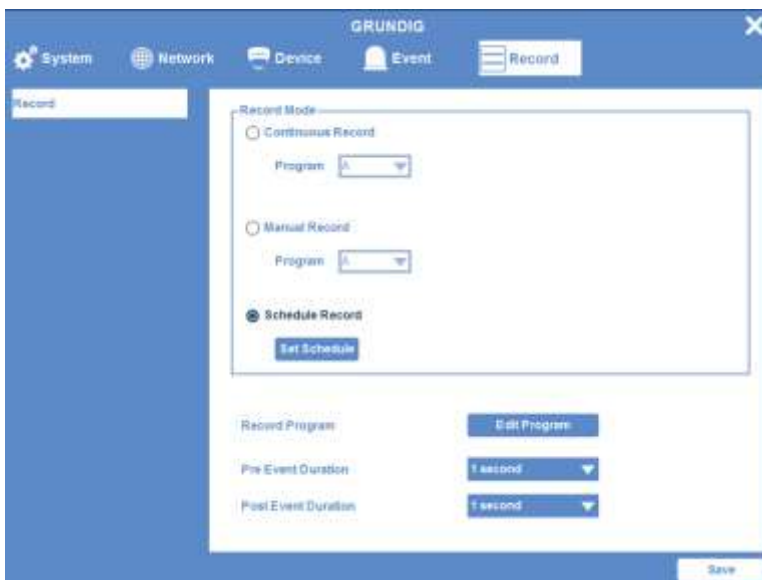

Select the days and the time zones which you want to record. You can also select different programs for different times.



- Program: Set the recording program (A~Z)
- Time: Set the applicable time
- Day : Set the day you want to record

- Program: Set the program you want to use for this day and time
- Delete selected: will delete the currently selected index
- Delete All: Will delete all indexes that are in the schedule list.

8.5.2. Program Setup

Here you can setup the recording resolution, frame rate and quality for every channel for normal recording and for event recording.

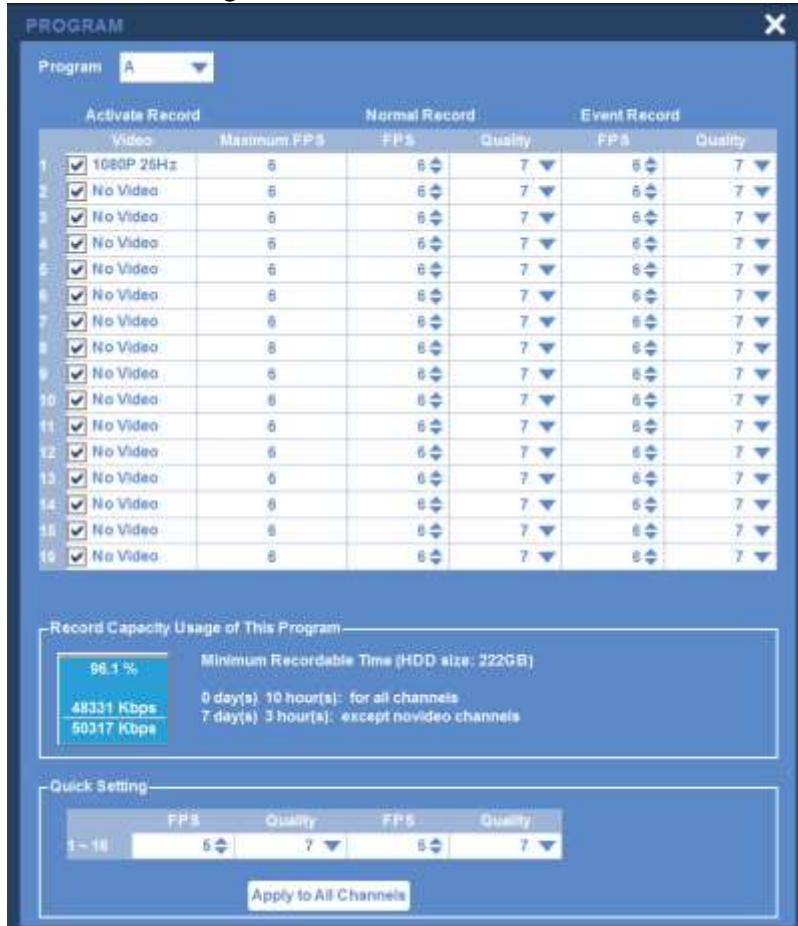

Program:

There are 9 programs from A to I composing the recording quality and resolution per channel. For a detailed explanation please refer to the program configuration below.

Video:

Displays the channel number.

Maximum FPS:

Displays the maximum possible frames per second you can use for this channel.

F (FPS):

FPS means frame per second. The user can select a frame rate from 1 to maximum fps. The max. frame rate can differ according to the configuration.

Q (Quality):

There are 7 recording qualities: Q7/ Q6/ Q5 / Q4 / Q3 / Q2 / Q1. The recommended quality for event recording is Q5. Q1 has a low quality which needs less storage space and Q7 is a higher quality which needs more storage space.

NOTE: If you disable a channel or lower its resolution or its frame rate the unused bandwidth can be used for other channels to increase their frame rate or resolution.

The relation between general recording and event recording:

When an event is triggered, the DVR records with the event recording settings. The recording performance of the DVR differs for every model.

Quick Settings:

Here you can apply the selected FPS and Quality to all channels at once.

9. GRUNDIG Web Viewer

The GRUNDIG WebViewer is a Web application program to access the DVR over an Ethernet or Internet connection. You can monitor the live view or access the recorded data with this program.

The GRUNDIG WebViewer is divided into the Login page, the Monitor page, where you can monitor the live video, and the Playback page to access recorded videos.

9.1. System Requirements

	Minimum	Recommendation
CPU	Intel Pentium 4 / 3.0GHz	Core2duo E6750 or higher
Main Memory	1GB	2GB or higher
Video Memory	128MB	512MB or higher
Display	1280 x 1024 (with 32bit colour) or higher	
HDD	1GB or higher	
OS	Windows XP Professional (over SP2) / Window Vista Business (over SP1)	
Others	DirectX 9.0 or higher	

9.2. Login

After inputting the IP address of the DVR, the GRUNDIG WebViewer Login page will be displayed in the browser window.

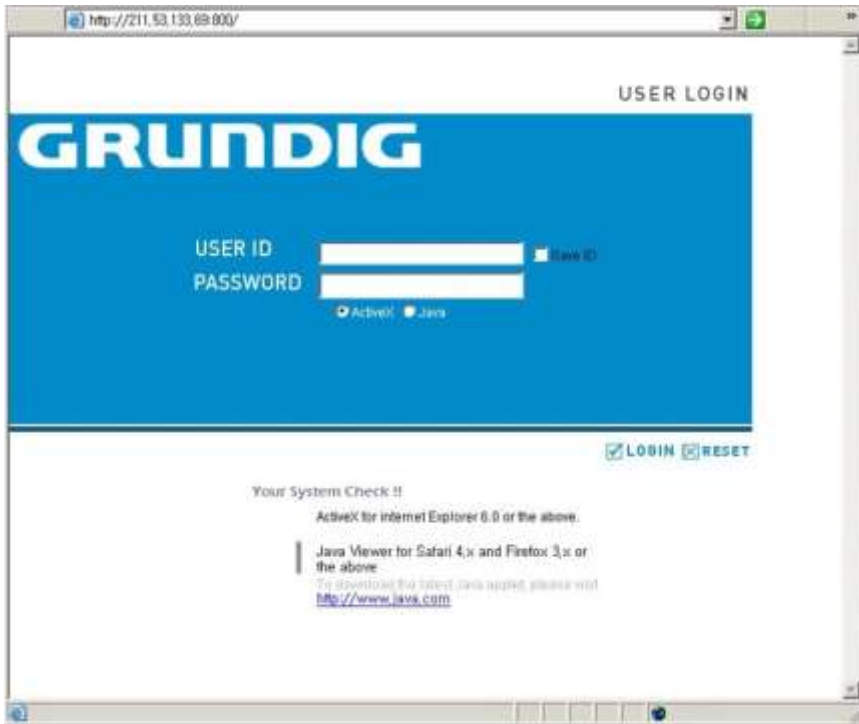

Input the User ID and Password and click 'LOGIN' to access.

If the user/administrator did not change the password in the Control Center, the ID and the Password will be: ID: admin / user1 / user2 / ... / user10
 Password: 1234 / 1111 / 2222 / .../ 0000

9.3. User Setup

To access the GRUNDIG WebViewer, user authority and password can be changed in the DVR or in the Control Center configuration (see the following images).

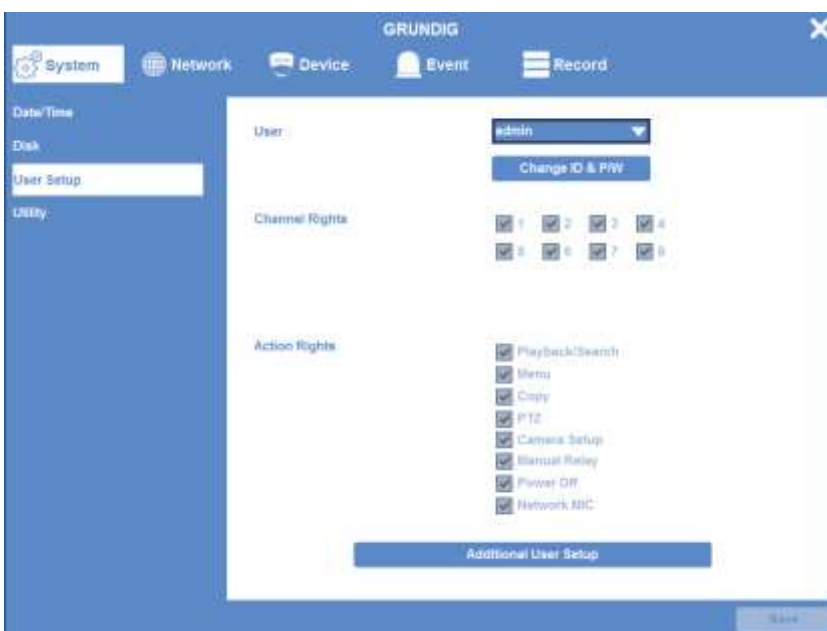

The basic admin password is "1234" and the user password is "1111" for User 1, "2222" for User 2 etc. The

password for User 10 is "0000". A valid password can have up to 8 digits.

This authority configuration is almost the same in the DVR as in the Control Center. But the authorisation of quick recording and the covering of dedicated channels for a user are only possible in the Control Center.

9.4. Available Browser

The GRUNDIG WebViewer is optimised for the Windows Internet Explorer 6.0 or higher. But GRUNDIG also supplies a Java based access to the DVR that can be used with other browsers like Mozilla Firefox, Apple Safari, Google Chrome or the Opera browser.

WebViewer Installer:

The Login page provides a manual installation program for the WebViewer.

A PC that accesses the WebViewer for the first time will install an ActiveX certificate to use the WebViewer's functions. If this installation fails, the installation program can be downloaded from the Login Page and installed manually.

Caution:

When installing the WebViewer Installer, all programs related to the Control Center have to be closed. Otherwise the installation might fail.

9.5. Monitor

When successfully authorised with User ID & Password input at the Login page, you will be directed to the Monitor page. On the Monitor page you can view live videos of cameras connected to DVR, or you can control a PTZ camera, Relays, and use the Microphone function according to user's authorisation.

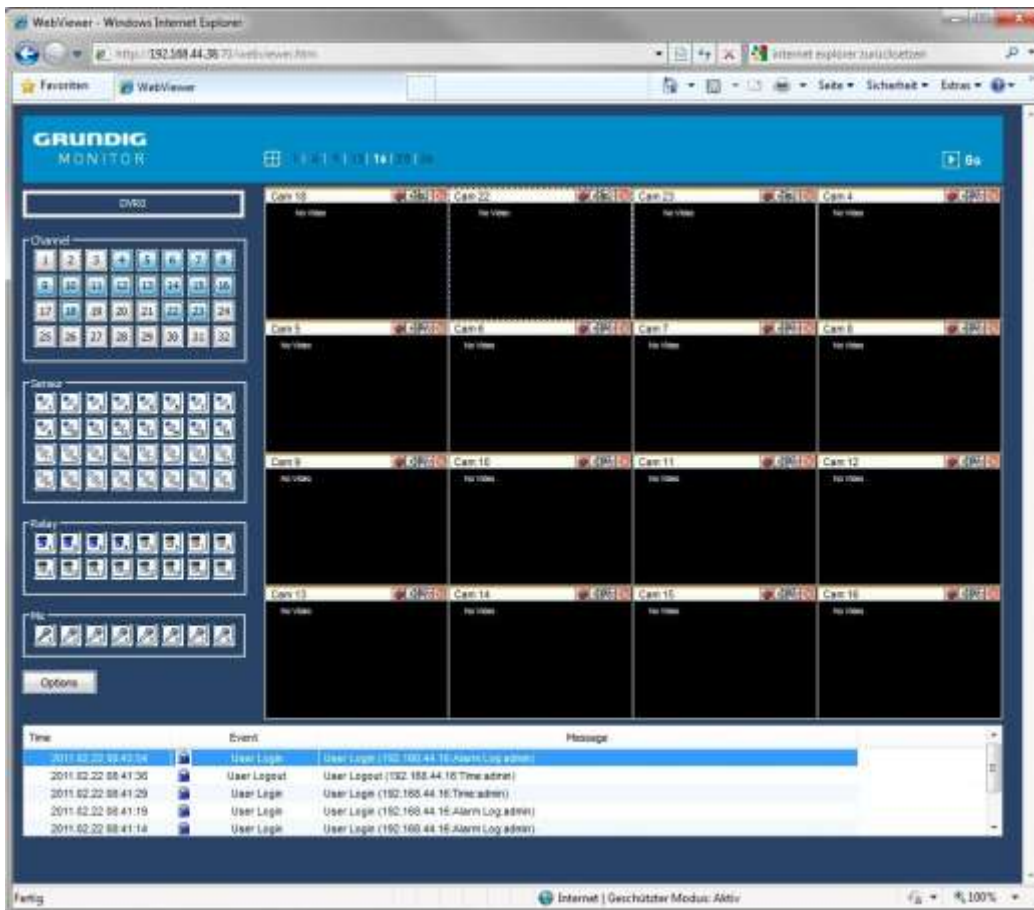

9.5.1. Screen division and changing video position

When accessing the Monitor page for the first time, 9 divisions, 16 divisions or 32 divisions (according to the number of channels of the DVR) are displayed.



You can change to 1, 4, 9, 13, 16, 25 or 36 divisions by clicking on the number on top of the page. Also, you can change to 1-channel mode by clicking on any of the channel images.

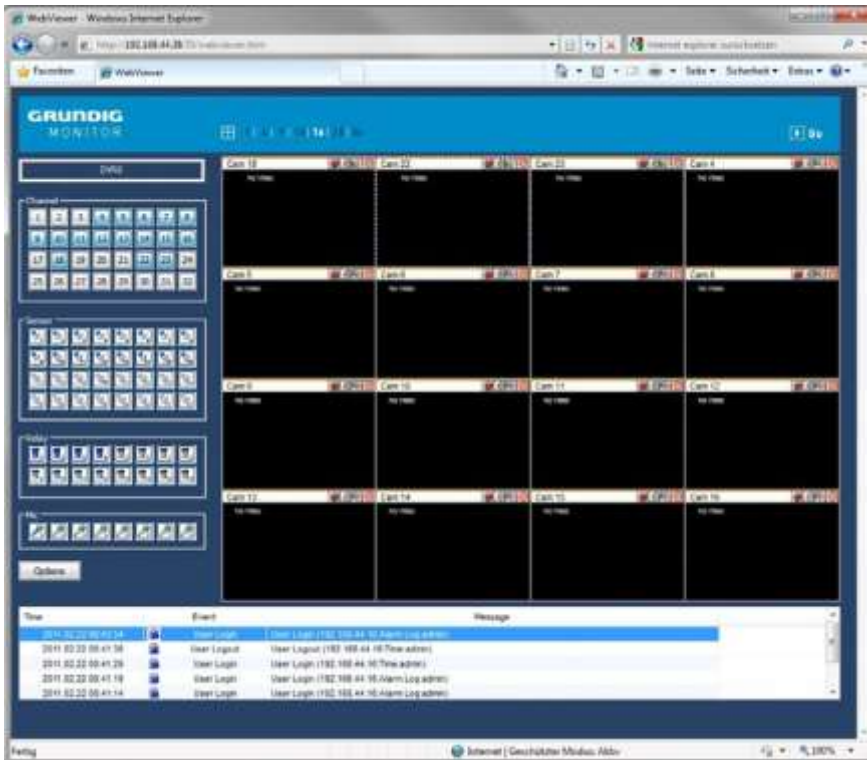

Double-click on one of the channels to switch to 1-channel mode.

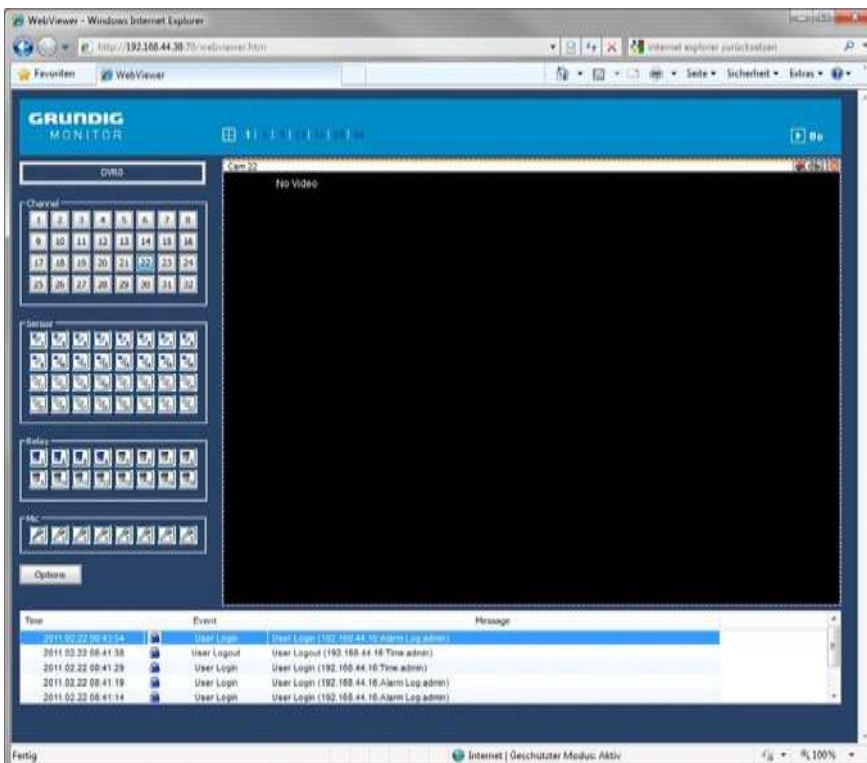

After entering 1-channel mode, a double-click on the screen will return to the previous division of channels. On the division screen, you can change the screen location.

If you want to move channel 3 to the position of channel 6, drag the 3ch image and drop it on the 6ch location. Channel 6 will automatically move to the former position of channel 3.

9.5.2. Playback on Standard monitor (16 / 9 / 4 division)



Move to the playback function by clicking on the image above.

9.5.3. Channel On/Off

You can select which channels are played by clicking the On/Off button of the Channel located on the left hand side of the page.

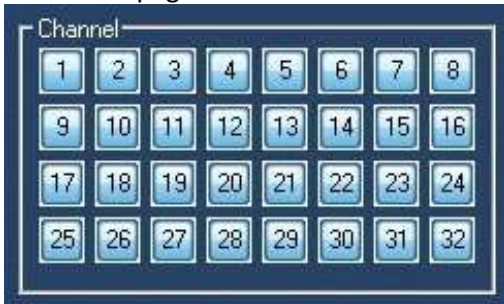

9.5.4. Sensor Indication

The icons indicate whether a sensor event occurred in the system.



When a sensor is activated, the relevant sensor icon will change to red colour.

9.5.5. Relay operation

You can turn on or off the relays of the DVR within the WebViewer. Click the number button to activate the relay and the icon will change from blue to orange.

If you define a time for the relay in the Control Center, the Control Center will be turned off automatically after this configuration.



Activating relays is only possible when the user possesses the authorisation. Refer to the chapter "User Authority" in this manual for the setup of user authority for relays.

9.5.6. Using a microphone

You can enable or disable the use of a microphone within the GRUNDIG WebViewer. The default setting is Off. If a microphone is activated, the colour of the corresponding icon will change from blue to red.



9.5.7. Event Data

The event log is displayed at the bottom of the monitoring page and shows all the event information stored on the DVR.

2009.03.31 10:42:13		7 On	CH7 - Motion Detected
2009.03.31 10:42:13		6 On	CH6 - Motion Detected
2009.03.31 10:42:13		5 On	CH5 - Motion Detected
2009.03.31 10:42:13		1 On	CH1 - Motion Detected
2009.03.31 10:42:13		16 On	CH16 - Motion Detected

9.5.8. Relay operation

The indicated data is listed as follows: [Table / Event Icon]

Button	Function
	Motion Detection On
	Sensor Input [Off, On]
	Relay Output [Off, On]
	No Video, Video Detected

9.5.9. Video Recording & Safe Saving

Video Recording:

During monitoring, the GRUNDIG WebViewer can record up to 10 minutes of video by clicking the Quick Recording button (the red dot in the top panel). During Quick Recording, the recording time is shown on the video.



During video recording, click the Quick Recording button to stop recording and a dialogue box will be opened to store the recorded files.

Saved recording files are saved in “*.re4” file format. The .re4 file can be played back by the GRUNDIG Control Center Playback software or the GRUNDIG Mini Player software.

Screenshots:

You can make a screenshot of the video by clicking on the right mouse button in the selected channel and by choosing the

“Save As” option. The picture can be stored in .jpg, .bmo or .eye file format.

9.5.10. Using PTZ

Among the icons on the top of a video in monitoring mode, click ‘PTZ’ to activate the control Pan, Tilt, Zoom, and Focus. If a PTZ camera is connected and already set to PTZ, this button is activated by default.



Pan/Tilt Control:

To control the PTZ with the mouse, click the right button and select “PTZ” or click the arrow button at the top. A Cross line on the middle of screen will be shown indicating that PTZ control is activated. Click within the image to operate the pan/tilt function.

Zoom/Focus Control:

Move the mouse to the left and right edge to see the slide bar for Zoom and Focus.

Move to Preset:

In case you have a set preset for a PTZ in the DVR, you can access it by right-clicking the mouse and selecting “Go to Preset”. When selecting a preset position from the preset list, the camera will move to the selected preset position.

Activating Auxiliary:

In case of a preset set, the “Auxiliary” function is indicated additionally, and can be operated after you selected the designated menu.

NOTE:

For a supported PTZ camera list please refer to 6.9. PTZ Control.

9.5.11. Using Audio

In case of Channel setup synchronisation with Audio, press the right mouse button on the channel to activate the pop-up menu “Listen” or activate the audio listen button. In the default setting the audio is muted. To activate the audio transmission, select it in the pop-up menu or click the corresponding button.



9.5.12. Closing Video Channel

You can disable and enable channels by clicking on the corresponding button at the top of the screen.

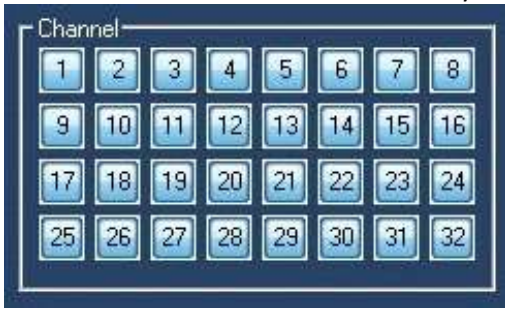

9.6. Playback

If you have the user rights to play back video, you can access the Playback screen when pressing the “Go” button on the Monitor screen of the GRUNDIG WebViewer.

In the Playback screen you can monitor up to 16 video streams simultaneously and search through a calendar to see recorded video from that date. You can make backups of the videos and save images in .bmp format or print them directly.

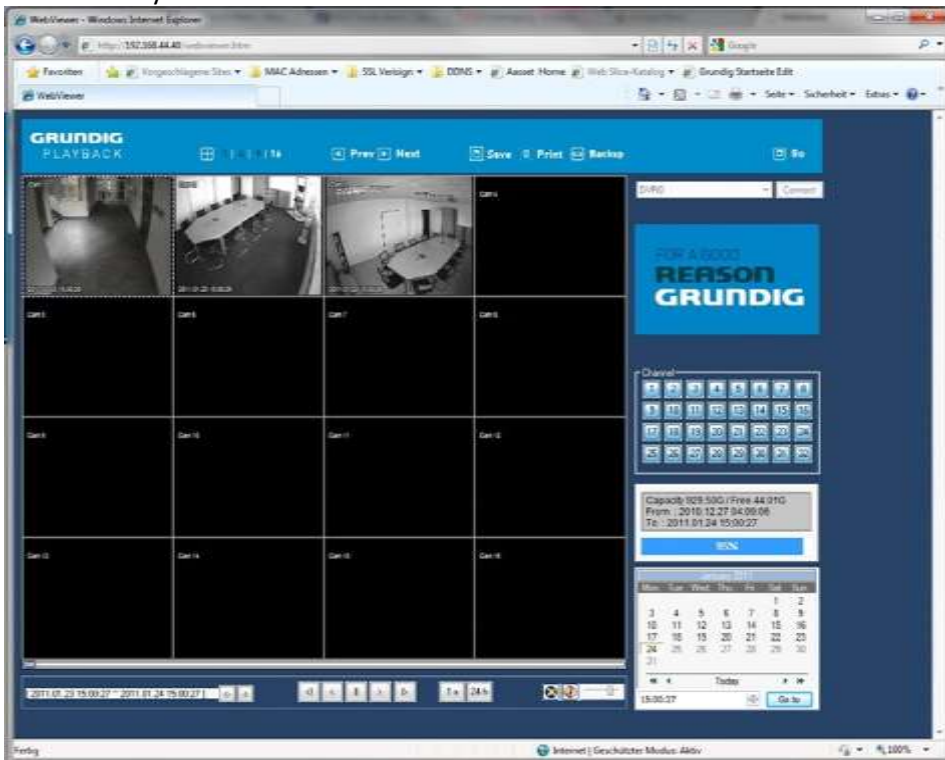

9.6.1. Video Division & Changing Channel



The Playback supports 1, 4, 9 and 16 divisional screens. You can select the number of divisions using the menu on the top of the page as shown in the picture above.



If the screen shows 4 divisions CH1~CH4, you can change to CH5~CH8 using the ‘Next’ button. Press the ‘Prev’ button to call for the previous channel group CH1~CH4.

9.6.2. Image recording

You can save a playback image as '.bmp' picture file.
Select the channel with the mouse and click the 'Save' button.



A Save Image dialogue box appears and you can input a memo text or select if the channel name, date and event data should be written into the file.

Press 'OK' to open the dialogue box for the saving location, then you can save it as a '.bmp' file.

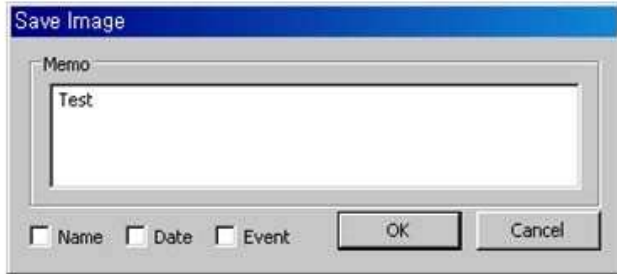

9.6.3. Printing

Select the channel you want to print, and click the 'Print' button.

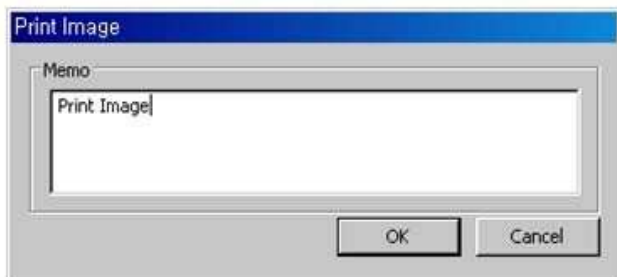

A window pops up to input a memo text. Click the 'OK' button to print the image on the connected printer. The Printout will include the 'Printing Date', 'Channel name', 'Recording Date', 'Event' and the 'Memo' text.

9.6.4. Backup

You can choose between .re4 (multi-channel) or .avi (single-channel) backup. Select the time, date and channel you want to back up and choose a location to save the file to.

If you want to secure the video file you can input a password which has to be verified.

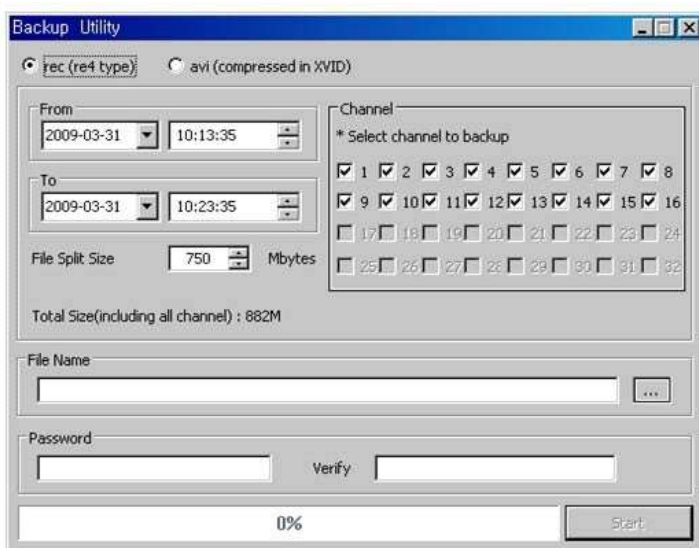

9.6.5.

Web Monitor

Click on the 'Go' button at the top of the page to return to the Web Monitor page.



9.6.6. Channel On/Off

This function is similar to the Channel On/Off function of the Web Monitor.

9.6.7. Saving Time & Checking Rec. Capacity

This field indicates the total capacity of the HDD and also displays the Starting date & Last date of the recorded video on the DVR. The image shows the percentage (%) of the DVR's HDD capacity.

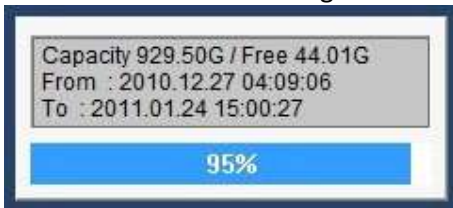

9.6.8. Searching in the Calendar

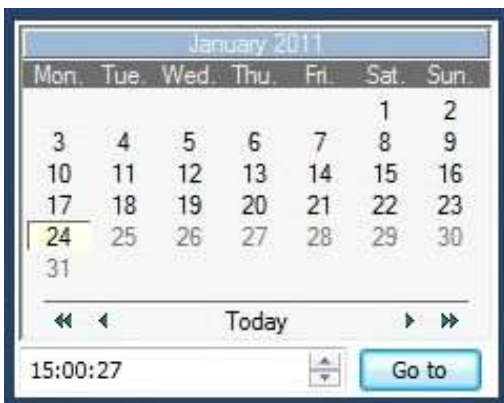

When a video was recorded on a special date, that day will be coloured in black. When a day is coloured in grey, this means that there was no video recorded on this date. Select the year, month, day and time to play back the video of that date.



When clicking on the 'Go to' button, you get access to the 24 hours of that date.

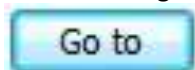

9.6.9. Functions at the bottom of monitor



(1) Indicates the playback range of the recorded image.

- (2) Press the -> <- buttons to jump to the time area of an earlier or later time.
- (3) From left to right: 'One frame back', 'Play backward', 'Stop', 'Play', 'One frame forward'.
- (4) Here you can set the playback speed. After clicking the button, it can set the playback speed to '0.5x, 1x, 2x, 4x, 16x, 32x, 64x, and All'.
- (5) Here you can set the time area. After clicking the button, select the time area out of '10min, 30min, 1hour, 3hour, 6hour, 12hour, 24hour'.
- (6) Here you can select if you want to use DirectX or not. If checking/activating DirectX mode, the WebViewer will use the graphic card of the PC to display the video. This will reduce the CPU workload.
- (7) Here you can set if audio should be played or not, and you can change the volume.

9.7. Java based Web Viewer

The GRUNDIG DVRs also support a connection based on Java. This technology can be used to get access to the DVR using another browser than the Microsoft Internet Explorer. The user just needs to select "Java" in the WebViewer start page.

While the opticaldesign looks slightly different than ActiveX, the basic functions are almost identical. You can have Multi-Views in Live mode, controlPTZ cameras and activate the relays over a network connection.

Playback is currently not available due to restrictions within the JAVA environment.

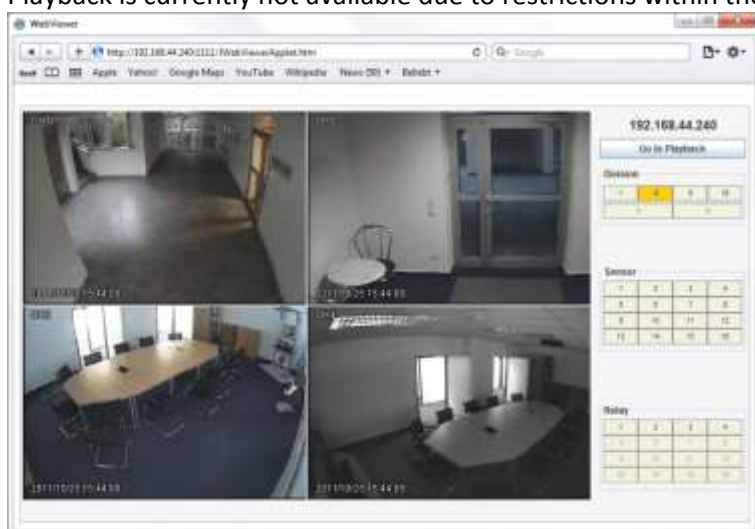

10. GRUNDIG Live Mobile Viewer

The GRUNDIG Mobile viewer is a viewer service for monitoring video with many different mobile devices. To access the mobile viewer, the user needs a mobile device supporting Wi-Fi or 3G.

10.1. Log-In Page

The picture below shows the Mobile viewer log-in page.

To access the log-in page via mobile viewer, please type in the address in the following format:

`http://IP/mvmenu.html`.

E.g.: `http://192.168.44.40/mvmenu.html`

or: `http://g0187D3A.grundig-ddns/mvmenu.html`

To log-in, please enter the ID and the password, select the resolution, the channel number and the refresh rate. Press the [Start View] button or [0] on a mobile phone without a touch screen to start the monitoring.



The image shows a web browser window displaying the 'GRUNDIG Live Mobile Viewer' configuration page. The browser's address bar shows the URL '192.168.44.40/mvmenu.htm'. The page has a blue background with white text and form fields. The title 'GRUNDIG Live Mobile Viewer' is prominently displayed at the top. Below the title, there are four input fields for configuration: '[1]User ID' with the value 'admin', '[2]Password' (empty), '[3]Channel' with the value '1', and '[4]Interval' with the value '5'. Underneath these fields is a section titled 'Select Resolution' with three radio button options: '[5] 180x120' (selected), '[6] 360x240', and '[7] 720x480'. There is also a checkbox for 'Old Browser Support' which is currently unchecked. At the bottom of the form is a button labeled '[0]Start View'.

10.2. Monitoring Page

The monitoring page shows the selected channel video and some functions you can use, right below the video display. The functions can be activated by pressing the buttons (touchscreen devices) or pressing the corresponding number on your phone keypad.

For the functions, please refer to the description below.

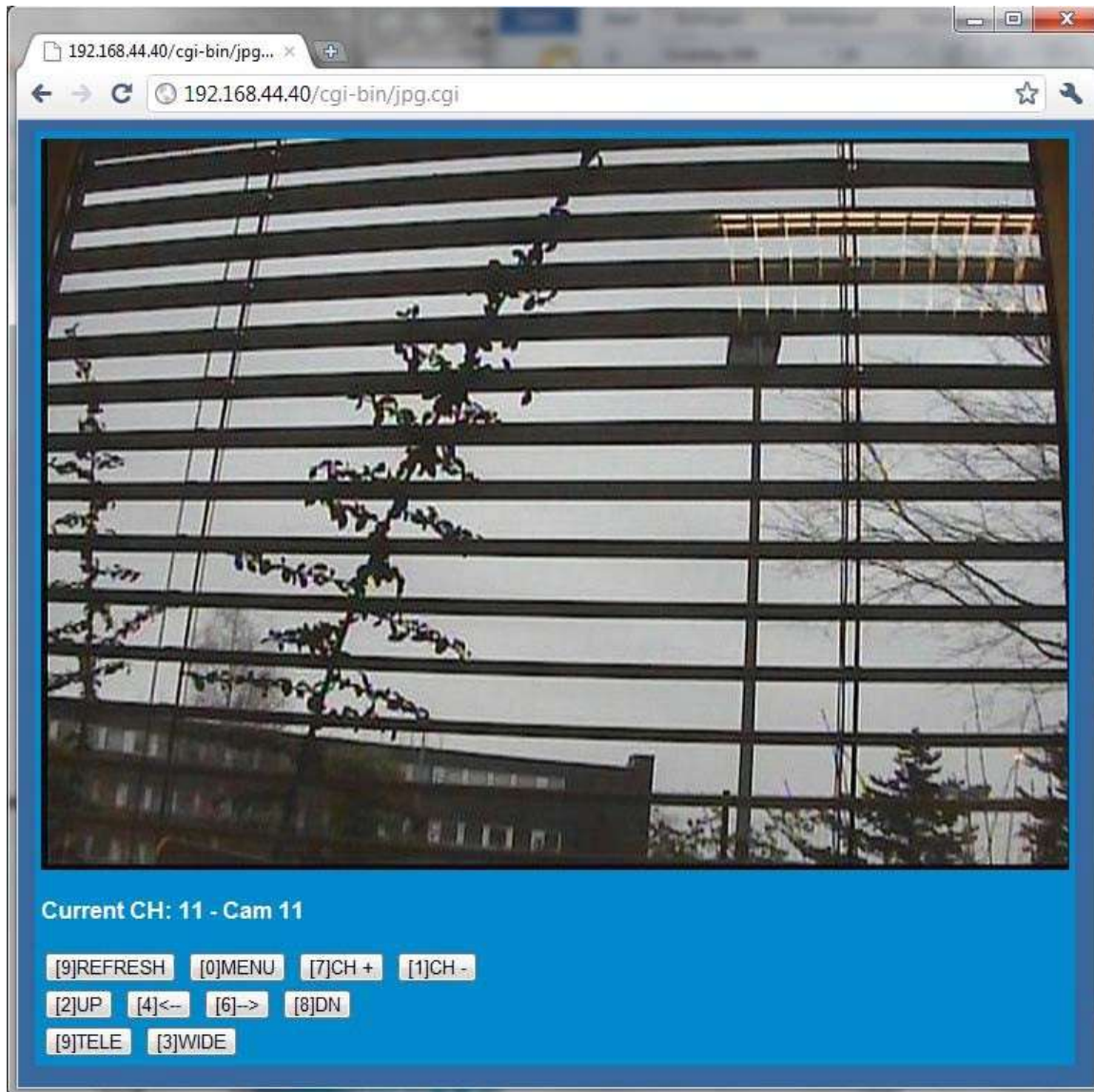

(0) MENU : Move back to Login page

(1) CH- : Move to previous channel

(2) UP : If the channel is PTZ you can move the camera up

(3) WIDE : If the channel is PTZ you can zoom out

(4) <- : If the channel is PTZ you can move the camera to the left (6) -> : If the channel is PTZ you can move the camera to the right (7) CH+ : Move to next channel

(8) DN : If the channel is PTZ you can move the camera down

(9) TELE : If the channel is PTZ you can zoom in



EC Declaration of Conformity

GRH-K1104B	4 Channel H.264 HD-SDI Recorder with DVD Drive
GRH-K2108B	8 Channel H.264 HD-SDI Recorder with DVD Drive
GRH-K4116B	16 Channel H.264 HD-SDI Recorder with DVD Drive

It is hereby certified that the products meet the standards in the following relevant provisions:

EC EMC Directive 2004/108/EC
Low Voltage Directive 2006/95/EC
AIMD Directive 90/385/EEC
R&TTE Directive 1999/5/EC

Applied harmonised standards and technical specifications:

EN 60950-1 (2006 +A11:2009+A1:2010+A12:2011)
EN 55022 (2010)
EN 55024 (2010)
EN 50130-4 (2011)
EN61000-3-2 (2006/A2:2009)
EN 61000-3-3 (2008)

ASP AG
Lüttringhauser Str. 9
42897 Remscheid
Germany

GRUNDIG

Remscheid, 18.12.2012

Ludwig Bergschneider
CEO

Open Source License Report on the Product

The software included in this product contains copyrighted software that is licensed under the GPL/LGPL. You may obtain the complete Corresponding Source code from us for a period of three years after our last shipment of this product by sending email to <info@asp-ag.eu>.

If you want to obtain the complete Corresponding Source code in a physical medium such as CD-ROM, the cost of physically performing source distribution might be charged.

GPL Software : busybox, boa, CyaSSL, dosfstools, linux kernel, rp-pppoe,

cdrtools, dvd+rw-tools, dhcpcd, iproute2, smartmontools

LGPL/GPL with exceptions : glibc, libgcc, libstdc++, FFMpeg, ftplib

Apache License : WenQuanYi Micro Hei

Copyright (c) 2007, Google Corp.; Copyright (c) 2008,2009 WenQuanYi Board of Trustees and Qianqian Fang.

Apache License : Apache Commons

<http://commons.apache.org>

BSD License : ash, minipnp, telnet-server, YUI Library, ppp

Freetype License : freetype2

Portions of this software included in this product are copyright (C) 2010 The

FreeType Project (www.freetype.org). All rights reserved. IJG

License : JPEG

The software included in this product is based in part on the work of the Independent JPEG Group.

MIT License : c-ares, curl, liboauth, jcodec

OpenSSL License : OpenSSL SIL Open Font

License : Arimo Copyright (c) 2010 Google

Corporation.

This Font Software is licensed under the SIL Open Font License, Version 1.1.

This license is copied in this manual, and is also available with a FAQ at:

<http://scripts.sil.org/OFL>

GNU GENERAL PUBLIC LICENSE

Version 2, June 1991

Copyright (C) 1989, 1991 Free Software Foundation, Inc.
51 Franklin Street, Fifth Floor, Boston, MA 02110-1301, USA

Everyone is permitted to copy and distribute verbatim copies of this license document, but changing it is not allowed.

Preamble

The licenses for most software are designed to take away your freedom to share and change it. By contrast, the GNU General Public License is intended to guarantee your freedom to share and change free software--to make sure the software is free for all its users. This General Public License applies to most of the Free Software Foundation's software and to any other program whose authors commit to using it. (Some other Free Software Foundation software is covered by the GNU Lesser General Public License instead.) You can apply it to your programs, too.

When we speak of free software, we are referring to freedom, not price. Our General Public Licenses are designed to make sure that you have the freedom to distribute copies of free software (and charge for this service if you wish), that you receive source code or can get it if you want it, that you can change the software or use pieces of it in new free programs; and that you know you can do these things.

To protect your rights, we need to make restrictions that forbid anyone to deny you these rights or to ask you to surrender the rights. These restrictions translate to certain responsibilities for you if you distribute copies of the software, or if you modify it.

For example, if you distribute copies of such a program, whether gratis or for a fee, you must give the recipients all the rights that you have. You must make sure that they, too, receive or can get the source code. And you must show them these terms so they know their rights.

We protect your rights with two steps: (1) copyright the software, and (2) offer you this license which gives you legal permission to copy, distribute and/or modify the software.

Also, for each author's protection and ours, we want to make certain that everyone understands that there is no warranty for this free software. If the software is modified by someone else and passed on, we want its recipients to know that what they have is not the original, so that any problems introduced by others will not reflect on the original authors' reputations.

Finally, any free program is threatened constantly by software patents. We wish to avoid the danger that redistributors of a free program will individually obtain patent licenses, in effect making the program proprietary. To prevent this, we have made it clear that any patent must be licensed for everyone's free use or not licensed at all.

The precise terms and conditions for copying, distribution and modification follow.

TERMS AND CONDITIONS FOR COPYING, DISTRIBUTION AND MODIFICATION

0. This License applies to any program or other work which contains a notice

placed by the copyright holder saying it may be distributed under the terms of this General Public License. The "Program", below, refers to any such program or work, and a "work based on the Program" means either the Program or any derivative work under copyright law: that is to say, a work containing the Program or a portion of it, either verbatim or with modifications and/or translated into another language. (Hereinafter, translation is included without limitation in the term "modification".) Each licensee is addressed as "you".

Activities other than copying, distribution and modification are not covered by this License; they are outside its scope. The act of running the Program is not restricted, and the output from the Program is covered only if its contents constitute a work based on the Program (independent of having been made by running the Program). Whether that is true depends on what the Program does.

1. You may copy and distribute verbatim copies of the Program's source code as you receive it, in any medium, provided that you conspicuously and appropriately publish on each copy an appropriate copyright notice and disclaimer of warranty; keep intact all the notices that refer to this License and to the absence of any warranty; and give any other recipients of the Program a copy of this License along with the Program.

You may charge a fee for the physical act of transferring a copy, and you may at your option offer warranty protection in exchange for a fee.

2. You may modify your copy or copies of the Program or any portion of it, thus forming a work based on the Program, and copy and distribute such modifications or work under the terms of Section 1 above, provided that you also meet all of these conditions:

a) You must cause the modified files to carry prominent notices stating that you changed the files and the date of any change.

b) You must cause any work that you distribute or publish, that in whole or in part contains or is derived from the Program or any part thereof, to be licensed as a whole at no charge to all third parties under the terms of this License.

c) If the modified program normally reads commands interactively when run, you must cause it, when started running for such interactive use in the most ordinary way, to print or display an announcement including an appropriate copyright notice and a notice that there is no warranty (or else, saying that you provide a warranty) and that users may redistribute the program under these conditions, and telling the user how to view a copy of this License. (Exception: if the Program itself is interactive but does not normally print such an announcement, your work based on the Program is not required to print an announcement.)

These requirements apply to the modified work as a whole. If identifiable sections of that work are not derived from the Program, and can be reasonably considered independent and separate works in themselves, then this License, and its terms, do not apply to those sections when you distribute them as separate works. But when you distribute the same sections as part of a whole which is a work based on the Program, the distribution of the whole must be on the terms of this License, whose permissions for other licensees extend to the entire whole, and thus to each and every part regardless of who wrote it.

Thus, it is not the intent of this section to claim rights or contest your rights to work written entirely by you; rather, the intent is to exercise the right to control the distribution of derivative or collective works based on the Program.

In addition, mere aggregation of another work not based on the Program with the Program (or with a work based on the Program) on a volume of a storage or distribution medium does not bring the other work under the scope of this License.

3. You may copy and distribute the Program (or a work based on it, under Section 2) in object code or executable form under the terms of Sections 1 and 2 above provided that you also do one of the following:

- a) Accompany it with the complete corresponding machine-readable source code, which must be distributed under the terms of Sections 1 and 2 above on a medium customarily used for software interchange; or,
- b) Accompany it with a written offer, valid for at least three years, to give any third party, for a charge no more than your cost of physically performing source distribution, a complete machine-readable copy of the corresponding source code, to be distributed under the terms of Sections 1 and 2 above on a medium customarily used for software interchange; or,
- c) Accompany it with the information you received as to the offer to distribute corresponding source code. (This alternative is allowed only for noncommercial distribution and only if you received the program in object code or executable form with such an offer, in accord with Subsection b above.)

The source code for a work means the preferred form of the work for making modifications to it. For an executable work, complete source code means all the source code for all modules it contains, plus any associated interface definition files, plus the scripts used to control compilation and installation of the executable. However, as a special exception, the source code distributed need not include anything that is normally distributed (in either source or binary form) with the major components (compiler, kernel, and so on) of the operating system on which the executable runs, unless that component itself accompanies the executable.

If distribution of executable or object code is made by offering access to copy from a designated place, then offering equivalent access to copy the source code from the same place counts as distribution of the source code, even though third parties are not compelled to copy the source along with the object code.

4. You may not copy, modify, sublicense, or distribute the Program except as expressly provided under this License. Any attempt otherwise to copy, modify, sublicense or distribute the Program is void, and will automatically terminate your rights under this License. However, parties who have received copies, or rights, from you under this License will not have their licenses terminated so long as such parties remain in full compliance.

5. You are not required to accept this License, since you have not signed it. However, nothing else grants you permission to modify or distribute the Program or its derivative works. These actions are prohibited by law if you do not accept this License. Therefore, by modifying or distributing the Program (or any work based on the Program), you indicate your acceptance of this License to do so, and all its terms and conditions for copying, distributing or modifying the Program or works based on it.

6. Each time you redistribute the Program (or any work based on the Program), the recipient automatically receives a license from the original licensor to copy, distribute or modify the Program subject to these terms and conditions. You may not impose any further restrictions on the recipients' exercise of the rights granted herein. You are not responsible for enforcing compliance by third parties to this License.

7. If, as a consequence of a court judgment or allegation of patent infringement or for any other reason (not limited to patent issues), conditions are imposed on you (whether by court order, agreement or otherwise) that contradict the conditions of this License, they do not excuse you from the conditions of this License. If you cannot distribute so as to satisfy simultaneously your obligations under this License and any other pertinent obligations, then as a consequence you may not distribute the Program at all. For example, if a patent license would not permit royalty-free redistribution of the Program by all those who receive copies directly or indirectly through you, then the only way you could satisfy both it and this License would be to refrain entirely from distribution of the Program.

If any portion of this section is held invalid or unenforceable under any particular circumstance, the balance of the section is intended to apply and the section as a whole is intended to apply in other circumstances.

It is not the purpose of this section to induce you to infringe any patents or other property right claims or to contest validity of any such claims; this section has the sole purpose of protecting the integrity of the free software distribution system, which is implemented by public license practices. Many people have made generous contributions to the wide range of software distributed through that system in reliance on consistent application of that system; it is up to the

author/donor to decide if he or she is willing to distribute software through any other system and a licensee cannot impose that choice.

This section is intended to make thoroughly clear what is believed to be a consequence of the rest of this License.

8. If the distribution and/or use of the Program is restricted in certain countries either by patents or by copyrighted interfaces, the original copyright holder who places the Program under this License may add an explicit geographical distribution limitation excluding those countries, so that distribution is permitted only in or among countries not thus excluded. In such case, this License incorporates the limitation as if written in the body of this License.

9. The Free Software Foundation may publish revised and/or new versions of the General Public License from time to time. Such new versions will be similar in spirit to the present version, but may differ in detail to address new problems or concerns.

Each version is given a distinguishing version number. If the Program specifies a version number of this License which applies to it and "any later version", you have the option of following the terms and conditions either of that version or of any later version published by the Free Software Foundation. If the Program does not specify a version number of this License, you may choose any version ever published by the Free Software Foundation.

10. If you wish to incorporate parts of the Program into other free programs whose distribution conditions are different, write to the author to ask for permission. For software which is copyrighted by the Free Software Foundation, write to the Free Software Foundation; we sometimes make exceptions for this. Our decision will be guided by the two goals of preserving the free status of all derivatives of our free software and of promoting the sharing and reuse of software generally.

NO WARRANTY

11. BECAUSE THE PROGRAM IS LICENSED FREE OF CHARGE, THERE IS NO WARRANTY FOR THE PROGRAM, TO THE EXTENT PERMITTED BY APPLICABLE LAW. EXCEPT WHEN OTHERWISE STATED IN WRITING THE COPYRIGHT HOLDERS AND/OR OTHER PARTIES PROVIDE THE PROGRAM "AS IS" WITHOUT WARRANTY OF ANY KIND, EITHER EXPRESSED OR IMPLIED, INCLUDING, BUT NOT LIMITED TO, THE IMPLIED WARRANTIES OF MERCHANTABILITY AND FITNESS FOR A PARTICULAR PURPOSE. THE ENTIRE RISK AS TO THE QUALITY AND PERFORMANCE OF THE PROGRAM IS WITH YOU. SHOULD THE PROGRAM PROVE DEFECTIVE, YOU ASSUME THE COST OF ALL NECESSARY SERVICING, REPAIR OR CORRECTION.

12. IN NO EVENT UNLESS REQUIRED BY APPLICABLE LAW OR AGREED TO IN WRITING WILL ANY COPYRIGHT HOLDER, OR ANY OTHER PARTY WHO MAY MODIFY AND/OR REDISTRIBUTE THE PROGRAM AS PERMITTED ABOVE, BE LIABLE TO YOU FOR DAMAGES, INCLUDING ANY GENERAL, SPECIAL, INCIDENTAL OR CONSEQUENTIAL DAMAGES ARISING OUT OF THE USE OR INABILITY TO USE THE PROGRAM (INCLUDING BUT NOT LIMITED TO LOSS OF DATA OR DATA BEING RENDERED INACCURATE OR LOSSES SUSTAINED BY YOU OR THIRD PARTIES OR A FAILURE OF THE PROGRAM TO OPERATE WITH ANY OTHER PROGRAMS), EVEN IF SUCH HOLDER OR OTHER PARTY HAS BEEN ADVISED OF THE POSSIBILITY OF SUCH DAMAGES.

END OF TERMS AND CONDITIONS

How to Apply These Terms to Your New Programs

If you develop a new program, and you want it to be of the greatest possible use to the public, the best way to achieve this is to make it free software which everyone can redistribute and change under these terms.

To do so, attach the following notices to the program. It is safest to attach them to the start of each source file to most effectively convey the exclusion of warranty; and each file should have at least the "copyright" line and a pointer to where the full notice is found.

one line to give the program's name and an idea of what it does.
Copyright (C) yyyy name of author

This program is free software; you can redistribute it and/or modify it under the terms of the GNU General Public License as published by the Free Software Foundation; either version 2 of the License, or (at your option) any later version.

This program is distributed in the hope that it will be useful, but WITHOUT ANY WARRANTY; without even the implied warranty of MERCHANTABILITY or FITNESS FOR A PARTICULAR PURPOSE. See the GNU General Public License for more details.

You should have received a copy of the GNU General Public License along with this program; if not, write to the Free Software

Foundation, Inc., 51 Franklin Street, Fifth Floor, Boston, MA 02110-1301, USA. Also

add information on how to contact you by electronic and paper mail.

If the program is interactive, make it output a short notice like this when it starts in an interactive mode:

```
Gnomovision version 69, Copyright (C) year name of author
Gnomovision comes with ABSOLUTELY NO WARRANTY; for details type
`show w'. This is free software, and you are welcome
to redistribute it under certain conditions; type `show c' for
details.
```

The hypothetical commands `show w' and `show c' should show the appropriate parts of the General Public License. Of course, the commands you use may be called something other than `show w' and `show c'; they could even be mouse-clicks or menu items--whatever suits your program.

You should also get your employer (if you work as a programmer) or your school, if any, to sign a "copyright disclaimer" for the program, if necessary. Here is a sample; alter the names:

```
Yoyodyne, Inc., hereby disclaims all copyright
interest in the program `Gnomovision'
(which makes passes at compilers) written by
James Hacker.
```

```
signature of Ty Coon, 1 April 1989
Ty Coon, President of Vice
```

This General Public License does not permit incorporating your program into proprietary programs. If your program is a subroutine library, you may consider it more useful to permit linking proprietary applications with the library. If this is what you want to do, use the [GNU Lesser General Public License](#) instead of this License.

GNU GENERAL PUBLIC LICENSE

Version 3, 29 June 2007

Copyright © 2007 Free Software Foundation, Inc. <<http://fsf.org/>>

Everyone is permitted to copy and distribute verbatim copies of this license document, but changing it is not allowed.

Preamble

The GNU General Public License is a free, copyleft license for software and other kinds of works.

The licenses for most software and other practical works are designed to take away your freedom to share and change the works. By contrast, the GNU General Public License is intended to guarantee your freedom to share and change all versions of a program—to make sure it remains free software for all its users. We, the Free Software Foundation, use the GNU General Public License for most of our software; it applies also to any other work released this way by its authors. You can apply it to your programs, too.

When we speak of free software, we are referring to freedom, not price. Our General Public Licenses are designed to make sure that you have the freedom to distribute copies of free software (and charge for them if you wish), that you receive source code or can get it if you want it, that you can change the software or use pieces of it in new free programs, and that you know you can do these things.

To protect your rights, we need to prevent others from denying you these rights or asking you to surrender the rights. Therefore, you have certain responsibilities if you distribute copies of the software, or if you modify it: responsibilities to respect the freedom of others.

For example, if you distribute copies of such a program, whether gratis or for a fee, you must pass on to the recipients the same freedoms that you received. You must make sure that they, too, receive or can get the source code. And you must show them these terms so they know their rights.

Developers that use the GNU GPL protect your rights with two steps: (1) assert copyright on the software, and (2) offer you this License giving you legal permission to copy, distribute and/or modify it.

For the developers' and authors' protection, the GPL clearly explains that there is no warranty for this free software. For both users' and authors' sake, the GPL requires that modified versions be marked as changed, so that their problems will not be attributed erroneously to authors of previous versions.

Some devices are designed to deny users access to install or run modified versions of the software inside them, although the manufacturer can do so. This is fundamentally incompatible with the aim of protecting users' freedom to change the software. The systematic pattern of such abuse occurs in the area of products for individuals to use, which is precisely where it is most unacceptable. Therefore, we have designed this version of the GPL to prohibit the practice for those products. If such problems arise substantially in other domains, we stand ready to extend this provision to those domains in future versions of the GPL, as needed to protect the freedom of users.

Finally, every program is threatened constantly by software patents. States should not allow patents to restrict development and use of software on general-purpose computers, but in those that do, we wish to avoid the special danger that patents applied to a free program could make it effectively proprietary. To prevent this, the GPL assures that patents cannot be used to render the program non-free.

The precise terms and conditions for copying, distribution and modification follow.

TERMS AND CONDITIONS

0. Definitions.

"This License" refers to version 3 of the GNU General Public License. "Copyright" also

means copyright-like laws that apply to other kinds of works, such as semiconductor masks.

"The Program" refers to any copyrightable work licensed under this License. Each licensee is addressed as "you". "Licensees" and "recipients" may be individuals or organizations.

To "modify" a work means to copy from or adapt all or part of the work in a fashion requiring copyright permission, other than the making of an exact copy. The resulting work is called a "modified version" of the earlier work or a work "based on" the earlier work.

A "covered work" means either the unmodified Program or a work based on the Program.

To "propagate" a work means to do anything with it that, without permission, would make you directly or secondarily liable for infringement under applicable copyright law, except executing it on a computer or modifying a private copy. Propagation includes copying, distribution (with or without modification), making available to the public, and in some countries other activities as well.

To "convey" a work means any kind of propagation that enables other parties to make or receive copies. Mere interaction with a user through a computer network, with no transfer of a copy, is not conveying.

An interactive user interface displays "Appropriate Legal Notices" to the extent that it includes a convenient and prominently visible feature that (1) displays an appropriate copyright notice, and (2) tells the user that there is no warranty for the work (except to the extent that warranties are provided), that licensees may convey the work under this License, and how to view a copy of this License. If the interface presents a list of user commands or options, such as a menu, a prominent item in the list meets this criterion.

1. Source Code.

The "source code" for a work means the preferred form of the work for making modifications to it. "Object code" means any non-source form of a work.

A "Standard Interface" means an interface that either is an official standard defined by a recognized standards body, or, in the case of interfaces specified for a particular programming language, one that is widely used among developers working in that language.

The "System Libraries" of an executable work include anything, other than the work as a whole, that (a) is included in the normal form of packaging a Major Component, but which is not part of that Major Component, and (b) serves only to enable use of the work with that Major Component, or to implement a Standard Interface for which an implementation is available to the public in source code form. A "Major Component", in this context, means a major essential component (kernel, window system, and so on) of the specific operating system (if any) on

which the executable work runs, or a compiler used to produce the work, or an object code interpreter used to run it.

The “Corresponding Source” for a work in object code form means all the source code needed to generate, install, and (for an executable work) run the object code and to modify the work, including scripts to control those activities. However, it does not include the work’s System Libraries, or general-purpose tools or generally available free programs which are used unmodified in performing those activities but which are not part of the work. For example, Corresponding Source includes interface definition files associated with source files for the work, and the source code for shared libraries and dynamically linked subprograms that the work is specifically designed to require, such as by intimate data communication or control flow between those subprograms and other parts of the work.

The Corresponding Source need not include anything that users can regenerate automatically from other parts of the Corresponding Source.

The Corresponding Source for a work in source code form is that same work.

2. Basic Permissions.

All rights granted under this License are granted for the term of copyright on the Program, and are irrevocable provided the stated conditions are met. This License explicitly affirms your unlimited permission to run the unmodified Program. The output from running a covered work is covered by this License only if the output, given its content, constitutes a covered work. This License acknowledges your rights of fair use or other equivalent, as provided by copyright law.

You may make, run and propagate covered works that you do not convey, without conditions so long as your license otherwise remains in force. You may convey covered works to others for the sole purpose of having them make modifications exclusively for you, or provide you with facilities for running those works, provided that you comply with the terms of this License in conveying all material for which you do not control copyright. Those thus making or running the covered works for you must do so exclusively on your behalf, under your direction and control, on terms that prohibit them from making any copies of your copyrighted material outside their relationship with you.

Conveying under any other circumstances is permitted solely under the conditions stated below. Sublicensing is not allowed; section 10 makes it unnecessary.

3. Protecting Users’ Legal Rights From Anti-Circumvention Law.

No covered work shall be deemed part of an effective technological measure under any applicable law fulfilling obligations under article 11 of the WIPO copyright treaty adopted on 20 December 1996, or similar laws prohibiting or restricting circumvention of such measures.

When you convey a covered work, you waive any legal power to forbid circumvention of technological measures to the extent such circumvention is effected by exercising rights under this License with respect to the covered work, and you disclaim any intention to limit operation or modification of the work as a means of enforcing, against the work’s users, your or third parties’ legal rights to forbid circumvention of technological measures.

4. Conveying Verbatim Copies.

You may convey verbatim copies of the Program’s source code as you receive it, in any medium, provided that you conspicuously and appropriately publish on each copy an appropriate copyright notice; keep intact all notices stating that this License and any non-permissive terms added in accord with section 7 apply to the code; keep intact all notices of the absence of any warranty; and give all recipients a copy of this License along with the Program.

You may charge any price or no price for each copy that you convey, and you may offer support or warranty protection for a fee.

5. Conveying Modified Source Versions.

You may convey a work based on the Program, or the modifications to produce it from the Program, in the form of source code under the terms of section 4, provided that you also meet all of these conditions:

- ☐ a) The work must carry prominent notices stating that you modified it, and giving a relevant date.
- ☐ b) The work must carry prominent notices stating that it is released under this License and any conditions added under section 7. This

requirement modifies the requirement in section 4 to “keep intact all notices”.

- ☐ c) You must license the entire work, as a whole, under this License to anyone who comes into possession of a copy. This License will therefore apply, along with any applicable section 7 additional terms, to the whole of the work, and all its parts, regardless of how they are packaged. This License gives no permission to license the work in any other way, but it does not invalidate such permission if you have separately received it.
- ☐ d) If the work has interactive user interfaces, each must display Appropriate Legal Notices; however, if the Program has interactive interfaces that do not display Appropriate Legal Notices, your work need not make them do so.

A compilation of a covered work with other separate and independent works, which are not by their nature extensions of the covered work, and which are not combined with it such as to form a larger program, in or on a volume of a storage or distribution medium, is called an “aggregate” if the compilation and its resulting copyright are not used to limit the access or legal rights of the compilation’s users beyond what the individual works permit. Inclusion of a covered work in an aggregate does not cause this License to apply to the other parts of the aggregate.

6. Conveying Non-Source Forms.

You may convey a covered work in object code form under the terms of sections 4 and 5, provided that you also convey the machine-readable Corresponding Source under the terms of this License, in one of these ways:

- ☐ a) Convey the object code in, or embodied in, a physical product (including a physical distribution medium), accompanied by the Corresponding Source fixed on a durable physical medium customarily used for software interchange.
- ☐ b) Convey the object code in, or embodied in, a physical product (including a physical distribution medium), accompanied by a written offer, valid for at least three years and valid for as long as you offer spare parts or customer support for that product model, to give anyone who possesses the object code either (1) a copy of the Corresponding Source for all the software in the product that is covered by this License, on a durable physical medium customarily used for software interchange, for a price no more than your reasonable cost of physically performing this conveying of source, or (2) access to copy the Corresponding Source from a network server at no charge.
- ☐ c) Convey individual copies of the object code with a copy of the written offer to provide the Corresponding Source. This alternative is allowed only occasionally and noncommercially, and only if you received the object code with such an offer, in accord with subsection 6b.
- ☐ d) Convey the object code by offering access from a designated place (gratis or for a charge), and offer equivalent access to the Corresponding Source in the same way through the same place at no further charge. You need not require recipients to copy the Corresponding Source along with the object code. If the place to copy the object code is a network server, the Corresponding Source may be on a different server (operated by you or a third party) that supports equivalent copying facilities, provided you maintain clear directions next to the object code saying where to find the Corresponding Source. Regardless of what server hosts the Corresponding Source, you remain obligated to ensure that it is available for as long as needed to satisfy these requirements.
- ☐ e) Convey the object code using peer-to-peer transmission, provided you inform other peers where the object code and Corresponding Source of the work are being offered to the general public at no charge under subsection 6d.

A separable portion of the object code, whose source code is excluded from the Corresponding Source as a System Library, need not be included in conveying the object code work.

A “User Product” is either (1) a “consumer product”, which means any tangible personal property which is normally used for personal, family, or household purposes, or (2) anything designed or sold for incorporation into a dwelling. In determining whether a product is a consumer product, doubtful cases shall be resolved in favor of coverage. For a particular product received by a particular user, “normally used” refers to a typical or common use of that class of product, regardless of the status of the particular user or of the way in which the particular user actually uses, or expects or is expected to use, the product. A product is a consumer product regardless of whether the product has substantial commercial, industrial or non-consumer uses, unless such uses represent the only significant mode of use of the product.

“Installation Information” for a User Product means any methods, procedures, authorization keys, or other information required to install and execute modified versions of a covered work in that User Product from a modified version of its Corresponding Source. The information must suffice to ensure that the

continued functioning of the modified object code is in no case prevented or interfered with solely because modification has been made.

If you convey an object code work under this section in, or with, or specifically for use in, a User Product, and the conveying occurs as part of a transaction in which the right of possession and use of the User Product is transferred to the recipient in perpetuity or for a fixed term (regardless of how the transaction is characterized), the Corresponding Source conveyed under this section must be accompanied by the Installation Information. But this requirement does not apply if neither you nor any third party retains the ability to install modified object code on the User Product (for example, the work has been installed in ROM).

The requirement to provide Installation Information does not include a requirement to continue to provide support service, warranty, or updates for a work that has been modified or installed by the recipient, or for the User Product in which it has been modified or installed. Access to a network may be denied when the modification itself materially and adversely affects the operation of the network or violates the rules and protocols for communication across the network.

Corresponding Source conveyed, and Installation Information provided, in accord with this section must be in a format that is publicly documented (and with an implementation available to the public in source code form), and must require no special password or key for unpacking, reading or copying.

7. Additional Terms.

“Additional permissions” are terms that supplement the terms of this License by making exceptions from one or more of its conditions. Additional permissions that are applicable to the entire Program shall be treated as though they were included in this License, to the extent that they are valid under applicable law. If additional permissions apply only to part of the Program, that part may be used separately under those permissions, but the entire Program remains governed by this License without regard to the additional permissions.

When you convey a copy of a covered work, you may at your option remove any additional permissions from that copy, or from any part of it. (Additional permissions may be written to require their own removal in certain cases when you modify the work.) You may place additional permissions on material, added by you to a covered work, for which you have or can give appropriate copyright permission.

Notwithstanding any other provision of this License, for material you add to a covered work, you may (if authorized by the copyright holders of that material) supplement the terms of this License with terms:

- Ⓜ a) Disclaiming warranty or limiting liability differently from the terms of sections 15 and 16 of this License; or
- Ⓜ b) Requiring preservation of specified reasonable legal notices or author attributions in that material or in the Appropriate Legal Notices displayed by works containing it; or
- Ⓜ c) Prohibiting misrepresentation of the origin of that material, or requiring that modified versions of such material be marked in reasonable ways as different from the original version; or
- Ⓜ d) Limiting the use for publicity purposes of names of licensors or authors of the material; or
- Ⓜ e) Declining to grant rights under trademark law for use of some trade names, trademarks, or service marks; or
- Ⓜ f) Requiring indemnification of licensors and authors of that material by anyone who conveys the material (or modified versions of it) with contractual assumptions of liability to the recipient, for any liability that these contractual assumptions directly impose on those licensors and authors.

All other non-permissive additional terms are considered “further restrictions” within the meaning of section 10. If the Program as you received it, or any part of it, contains a notice stating that it is governed by this License along with a term that is a further restriction, you may remove that term. If a license document contains a further restriction but permits relicensing or conveying under this License, you may add to a covered work material governed by the terms of that license document, provided that the further restriction does not survive such relicensing or conveying.

If you add terms to a covered work in accord with this section, you must place, in the relevant source files, a statement of the additional terms that apply to those files, or a notice indicating where to find the applicable terms.

Additional terms, permissive or non-permissive, may be stated in the form of a separately written license, or stated as exceptions; the above requirements apply either way.

8. Termination.

You may not propagate or modify a covered work except as expressly provided under this License. Any attempt otherwise to propagate or modify it is void, and will automatically terminate your rights under this License (including any patent licenses granted under the third paragraph of section 11).

However, if you cease all violation of this License, then your license from a particular copyright holder is reinstated (a) provisionally, unless and until the copyright holder explicitly and finally terminates your license, and (b) permanently, if the copyright holder fails to notify you of the violation by some reasonable means prior to 60 days after the cessation.

Moreover, your license from a particular copyright holder is reinstated permanently if the copyright holder notifies you of the violation by some reasonable means, this is the first time you have received notice of violation of this License (for any work) from that copyright holder, and you cure the violation prior to 30 days after your receipt of the notice.

Termination of your rights under this section does not terminate the licenses of parties who have received copies or rights from you under this License. If your rights have been terminated and not permanently reinstated, you do not qualify to receive new licenses for the same material under section 10.

9. Acceptance Not Required for Having Copies.

You are not required to accept this License in order to receive or run a copy of the Program. Ancillary propagation of a covered work occurring solely as a consequence of using peer-to-peer transmission to receive a copy likewise does not require acceptance. However, nothing other than this License grants you permission to propagate or modify any covered work. These actions infringe copyright if you do not accept this License. Therefore, by modifying or propagating a covered work, you indicate your acceptance of this License to do so.

10. Automatic Licensing of Downstream Recipients.

Each time you convey a covered work, the recipient automatically receives a license from the original licensors, to run, modify and propagate that work, subject to this License. You are not responsible for enforcing compliance by third parties with this License.

An “entity transaction” is a transaction transferring control of an organization, or substantially all assets of one, or subdividing an organization, or merging organizations. If propagation of a covered work results from an entity transaction, each party to that transaction who receives a copy of the work also receives whatever licenses to the work the party’s predecessor in interest had or could give under the previous paragraph, plus a right to possession of the Corresponding Source of the work from the predecessor in interest, if the predecessor has it or can get it with reasonable efforts.

You may not impose any further restrictions on the exercise of the rights granted or affirmed under this License. For example, you may not impose a license fee, royalty, or other charge for exercise of rights granted under this License, and you may not initiate litigation (including a cross-claim or counterclaim in a lawsuit) alleging that any patent claim is infringed by making, using, selling, offering for sale, or importing the Program or any portion of it.

11. Patents.

A “contributor” is a copyright holder who authorizes use under this License of the Program or a work on which the Program is based. The work thus licensed is called the contributor’s “contributor version”.

A contributor’s “essential patent claims” are all patent claims owned or controlled by the contributor, whether already acquired or hereafter acquired, that would be infringed by some manner, permitted by this License, of making, using, or selling its contributor version, but do not include claims that would be infringed only as a consequence of further modification of the contributor version. For purposes of this definition, “control” includes the right to grant patent sublicenses in a manner consistent with the requirements of this License.

Each contributor grants you a non-exclusive, worldwide, royalty-free patent license under the contributor’s essential patent claims, to make, use, sell, offer for sale, import and otherwise run, modify and propagate the contents of its contributor version.

In the following three paragraphs, a “patent license” is any express agreement or commitment, however denominated, not to enforce a patent (such as an express permission to practice a patent or covenant not to sue for patent infringement). To “grant” such a patent license to a party means to make such an agreement or commitment not to enforce a patent against the party.

If you convey a covered work, knowingly relying on a patent license, and the Corresponding Source of the work is not available for anyone to copy, free of charge and under the terms of this License, through a publicly available network server or other readily accessible means, then you must either (1) cause the Corresponding Source to be so available, or (2) arrange to deprive yourself of the benefit of the patent license for this particular work, or (3) arrange, in a manner consistent with the requirements of this License, to extend the patent license to downstream recipients. "Knowingly relying" means you have actual knowledge that, but for the patent license, your conveying the covered work in a country, or your recipient's use of the covered work in a country, would infringe one or more identifiable patents in that country that you have reason to believe are valid.

If, pursuant to or in connection with a single transaction or arrangement, you convey, or propagate by procuring conveyance of, a covered work, and grant a patent license to some of the parties receiving the covered work authorizing them to use, propagate, modify or convey a specific copy of the covered work, then the patent license you grant is automatically extended to all recipients of the covered work and works based on it.

A patent license is "discriminatory" if it does not include within the scope of its coverage, prohibits the exercise of, or is conditioned on the non-exercise of one or more of the rights that are specifically granted under this License. You may not convey a covered work if you are a party to an arrangement with a third party that is in the business of distributing software, under which you make payment to the third party based on the extent of your activity of conveying the work, and under which the third party grants, to any of the parties who would receive the covered work from you, a discriminatory patent license (a) in connection with copies of the covered work conveyed by you (or copies made from those copies), or (b) primarily for and in connection with specific products or compilations that contain the covered work, unless you entered into that arrangement, or that patent license was granted, prior to 28 March 2007.

Nothing in this License shall be construed as excluding or limiting any implied license or other defenses to infringement that may otherwise be available to you under applicable patent law.

12. No Surrender of Others' Freedom.

If conditions are imposed on you (whether by court order, agreement or otherwise) that contradict the conditions of this License, they do not excuse you from the conditions of this License. If you cannot convey a covered work so as to satisfy simultaneously your obligations under this License and any other pertinent obligations, then as a consequence you may not convey it at all. For example, if you agree to terms that obligate you to collect a royalty for further conveying from those to whom you convey the Program, the only way you could satisfy both those terms and this License would be to refrain entirely from conveying the Program.

13. Use with the GNU Affero General Public License.

Notwithstanding any other provision of this License, you have permission to link or combine any covered work with a work licensed under version 3 of the GNU Affero General Public License into a single combined work, and to convey the resulting work. The terms of this License will continue to apply to the part which is the covered work, but the special requirements of the GNU Affero General Public License, section 13, concerning interaction through a network will apply to the combination as such.

14. Revised Versions of this License.

The Free Software Foundation may publish revised and/or new versions of the GNU General Public License from time to time. Such new versions will be similar in spirit to the present version, but may differ in detail to address new problems or concerns.

Each version is given a distinguishing version number. If the Program specifies that a certain numbered version of the GNU General Public License "or any later version" applies to it, you have the option of following the terms and conditions either of that numbered version or of any later version published by the Free Software Foundation. If the Program does not specify a version number of the GNU General Public License, you may choose any version ever published by the Free Software Foundation.

If the Program specifies that a proxy can decide which future versions of the GNU General Public License can be used, that proxy's public statement of acceptance of a version permanently authorizes you to choose that version for the Program.

Later license versions may give you additional or different permissions. However, no additional obligations are imposed on any author or copyright holder as a result of your choosing to follow a later version.

15. Disclaimer of Warranty.

THERE IS NO WARRANTY FOR THE PROGRAM, TO THE EXTENT PERMITTED BY APPLICABLE LAW. EXCEPT WHEN OTHERWISE STATED IN WRITING THE COPYRIGHT HOLDERS AND/OR OTHER PARTIES PROVIDE THE PROGRAM "AS IS" WITHOUT WARRANTY OF ANY KIND, EITHER EXPRESSED OR IMPLIED, INCLUDING, BUT NOT LIMITED TO, THE IMPLIED WARRANTIES OF MERCHANTABILITY AND FITNESS FOR A PARTICULAR PURPOSE. THE ENTIRE RISK AS TO THE QUALITY AND PERFORMANCE OF THE PROGRAM IS WITH YOU. SHOULD THE PROGRAM PROVE DEFECTIVE, YOU ASSUME THE COST OF ALL NECESSARY SERVICING, REPAIR OR CORRECTION.

16. Limitation of Liability.

IN NO EVENT UNLESS REQUIRED BY APPLICABLE LAW OR AGREED TO IN WRITING WILL ANY COPYRIGHT HOLDER, OR ANY OTHER PARTY WHO MODIFIES AND/OR CONVEYS THE PROGRAM AS PERMITTED ABOVE, BE LIABLE TO YOU FOR DAMAGES, INCLUDING ANY GENERAL, SPECIAL, INCIDENTAL OR CONSEQUENTIAL DAMAGES ARISING OUT OF THE USE OR INABILITY TO USE THE PROGRAM (INCLUDING BUT NOT LIMITED TO LOSS OF DATA OR DATA BEING RENDERED INACCURATE OR LOSSES SUSTAINED BY YOU OR THIRD PARTIES OR A FAILURE OF THE PROGRAM TO OPERATE WITH ANY OTHER PROGRAMS), EVEN IF SUCH HOLDER OR OTHER PARTY HAS BEEN ADVISED OF THE POSSIBILITY OF SUCH DAMAGES.

17. Interpretation of Sections 15 and 16.

If the disclaimer of warranty and limitation of liability provided above cannot be given local legal effect according to their terms, reviewing courts shall apply local law that most closely approximates an absolute waiver of all civil liability in connection with the Program, unless a warranty or assumption of liability accompanies a copy of the Program in return for a fee.

END OF TERMS AND CONDITIONS

How to Apply These Terms to Your New Programs

If you develop a new program, and you want it to be of the greatest possible use to the public, the best way to achieve this is to make it free software which everyone can redistribute and change under these terms.

To do so, attach the following notices to the program. It is safest to attach them to the start of each source file to most effectively state the exclusion of warranty; and each file should have at least the "copyright" line and a pointer to where the full notice is found.

```
<one line to give the program's name and a brief idea of what it does.>
Copyright (C) <year> <name of author>
```

```
This program is free software: you can redistribute it and/or modify
it under the terms of the GNU General Public License as published by the
Free Software Foundation, either version 3 of the License, or
(at your option) any later version.
```

```
This program is distributed in the hope that it will be useful,
but WITHOUT ANY WARRANTY; without even the implied warranty of
MERCHANTABILITY or FITNESS FOR A PARTICULAR PURPOSE. See the GNU
General Public License for more details.
```

```
You should have received a copy of the GNU General Public License along
with this program. If not, see <http://www.gnu.org/licenses/>.
```

Also add information on how to contact you by electronic and paper mail.

If the program does terminal interaction, make it output a short notice like this when it starts in an interactive mode:

```
<program> Copyright (C) <year> <name of author>
This program comes with ABSOLUTELY NO WARRANTY; for details type
`show w'.
This is free software, and you are welcome to redistribute it
under certain conditions; type `show c' for details.
```

The hypothetical commands `show w' and `show c' should show the appropriate parts of the General Public License. Of course, your program's commands might be different; for a GUI interface, you would use an "about box".

You should also get your employer (if you work as a programmer) or school, if any, to sign a "copyright disclaimer" for the program, if necessary. For more information on this, and how to apply and follow the GNU GPL, see <http://www.gnu.org/licenses/>.

The GNU General Public License does not permit incorporating your program into proprietary programs. If your program is a subroutine library, you may consider it more useful to permit linking proprietary applications with the library. If this is what you want to do, use the GNU Lesser General Public License instead of this License. But first, please read <<http://www.gnu.org/philosophy/why-not-lgpl.html>>.

GNU LESSER GENERAL PUBLIC LICENSE

Version 2.1, February 1999

Copyright (C) 1991, 1999 Free Software Foundation, Inc.
51 Franklin Street, Fifth Floor, Boston, MA 02110-1301 USA
Everyone is permitted to copy and distribute verbatim copies of this license document, but changing it is not allowed.

[This is the first released version of the Lesser GPL. It also counts as the successor of the GNU Library Public License, version 2, hence the version number 2.1.]

Preamble

The licenses for most software are designed to take away your freedom to share and change it. By contrast, the GNU General Public Licenses are intended to guarantee you freedom to share and change free software--to make sure the software is free for all its users.

This license, the Lesser General Public License, applies to some specially designated software packages--typically libraries--of the Free Software Foundation and other authors who decide to use it. You can use it too, but we suggest you first think carefully about whether this license or the ordinary General Public License is the better strategy to use in any particular case, based on the explanations below.

When we speak of free software, we are referring to freedom of use, not price. Our General Public Licenses are designed to make sure that you have the freedom to distribute copies of free software (and charge for this service if you wish); that you receive source code or can get it if you want it; that you can change the software and use pieces of it in new free programs; and that you are informed that you can do these things.

To protect your rights, we need to make restrictions that forbid distributors to deny you these rights or to ask you to surrender these rights. These restrictions translate to certain responsibilities for you if you distribute copies of the library or if you modify it.

For example, if you distribute copies of the library, whether gratis or for a fee, you must give the recipients all the rights that we gave you. You must make sure that they, too, receive or can get the source code. If you link other code with the library, you must provide complete object files to the recipients, so that they can relink them with the library after making changes to the library and recompiling it. And you must show them these terms so they know their rights.

We protect your rights with a two-step method: (1) we copyright the library, and (2) we offer you this license, which gives you legal permission to copy, distribute and/or modify the library.

To protect each distributor, we want to make it very clear that there is no warranty for the free library. Also, if the library is modified by someone else and passed on, the recipients should know that what they have is not the original version, so that the original author's reputation will not be affected by problems that might be introduced by others.

Finally, software patents pose a constant threat to the existence of any free program. We wish to make sure that a company cannot effectively restrict the users of a free program by obtaining a restrictive license from a patent holder. Therefore, we insist that any patent license obtained for a version of the library must be consistent with the full freedom of use specified in this license.

Most GNU software, including some libraries, is covered by the ordinary GNU General Public License. This license, the GNU Lesser General Public License, applies to certain designated libraries, and is quite different from the ordinary General Public License. We use this license for certain libraries in order to permit linking those libraries into non-free programs.

When a program is linked with a library, whether statically or using a shared library, the combination of the two is legally speaking a combined work, a derivative of the original library. The ordinary General Public License therefore permits such linking only if the entire combination fits its criteria of freedom. The Lesser General Public License permits more lax criteria for linking other code with the library.

We call this license the "Lesser" General Public License because it does Less to protect the user's freedom than the ordinary General Public License. It also provides other free software developers Less of an advantage over competing non-free programs. These disadvantages are the reason we use the ordinary General Public License for many libraries. However, the Lesser license provides advantages in certain special circumstances.

For example, on rare occasions, there may be a special need to encourage the widest possible use of a certain library, so that it becomes a de-facto standard. To achieve this, non-free programs must be allowed to use the library. A more frequent case is that a free library does the same job as widely used non-free libraries. In this case, there is little to gain by limiting the free library to free software only, so we use the Lesser General Public License.

In other cases, permission to use a particular library in non-free programs enables a greater number of people to use a large body of free software. For example, permission to use the GNU C Library in non-free programs enables many more people to use the whole GNU operating system, as well as its variant, the GNU/Linux operating system.

Although the Lesser General Public License is Less protective of the users' freedom, it does ensure that the user of a program that is linked with the Library has the freedom and the wherewithal to run that program using a modified version of the Library.

The precise terms and conditions for copying, distribution and modification follow. Pay close attention to the difference between a "work based on the library" and a "work that uses the library". The former contains code derived from the library, whereas the latter must be combined with the library in order to run.

TERMS AND CONDITIONS FOR COPYING, DISTRIBUTION AND MODIFICATION

0. This License Agreement applies to any software library or other program which contains a notice placed by the copyright holder or other authorized party saying it may be distributed under the terms of this Lesser General Public License (also called "this License"). Each licensee is addressed as "you".

A "library" means a collection of software functions and/or data prepared so as to be conveniently linked with application programs (which use some of those functions and data) to form executables.

The "Library", below, refers to any such software library or work which has been distributed under these terms. A "work based on the Library" means either the Library or any derivative work under copyright law: that is to say, a work containing the Library or a portion of it, either verbatim or with modifications and/or translated straightforwardly into another language. (Hereinafter, translation is included without limitation in the term "modification".)

"Source code" for a work means the preferred form of the work for making modifications to it. For a library, complete source code means all the source code for all modules it contains, plus any associated interface definition files, plus the scripts used to control compilation and installation of the library.

Activities other than copying, distribution and modification are not covered by this License; they are outside its scope. The act of running a program using the Library is not restricted, and output from such a program is covered only if its contents constitute a work based on the Library (independent of the use of the Library in a tool for writing it). Whether that is true depends on what the Library does and what the program that uses the Library does.

1. You may copy and distribute verbatim copies of the Library's complete source code as you receive it, in any medium, provided that you conspicuously and appropriately publish on each copy an appropriate copyright notice and disclaimer of warranty; keep intact all the notices that refer to this License and to the absence of any warranty; and distribute a copy of this License along with the Library.

You may charge a fee for the physical act of transferring a copy, and you may at your option offer warranty protection in exchange for a fee.

2. You may modify your copy or copies of the Library or any portion of it, thus forming a work based on the Library, and copy and distribute such modifications or work under the terms of Section 1 above, provided that you also meet all of these conditions:

- a) The modified work must itself be a software library.
- b) You must cause the files modified to carry prominent notices stating that you changed the files and the date of any change.
- c) You must cause the whole of the work to be licensed at no charge to all third parties under the terms of this License.

- 2) **d)** If a facility in the modified Library refers to a function or a table of data to be supplied by an application program that uses the facility, other than as an argument passed when the facility is invoked, then you must make a good faith effort to ensure that, in the event an application does not supply such function or table, the facility still operates, and performs whatever part of its purpose remains meaningful.

(For example, a function in a library to compute square roots has a purpose that is entirely well-defined independent of the application. Therefore, Subsection 2d requires that any application-supplied function or table used by this function must be optional: if the application does not supply it, the square root function must still compute square roots.)

These requirements apply to the modified work as a whole. If identifiable sections of that work are not derived from the Library, and can be reasonably considered independent and separate works in themselves, then this License, and its terms, do not apply to those sections when you distribute them as separate works. But when you distribute the same sections as part of a whole which is a work based on the Library, the distribution of the whole must be on the terms of this License, whose permissions for other licensees extend to the entire whole, and thus to each and every part regardless of who wrote it.

Thus, it is not the intent of this section to claim rights or contest your rights to work written entirely by you; rather, the intent is to exercise the right to control the distribution of derivative or collective works based on the Library.

In addition, mere aggregation of another work not based on the Library with the Library (or with a work based on the Library) on a volume of a storage or distribution medium does not bring the other work under the scope of this License.

3. You may opt to apply the terms of the ordinary GNU General Public License instead of this License to a given copy of the Library. To do this, you must alter all the notices that refer to this License, so that they refer to the ordinary GNU General Public License, version 2, instead of to this License. (If a newer version than version 2 of the ordinary GNU General Public License has appeared, then you can specify that version instead if you wish.) Do not make any other change in these notices.

Once this change is made in a given copy, it is irreversible for that copy, so the ordinary GNU General Public License applies to all subsequent copies and derivative works made from that copy.

This option is useful when you wish to copy part of the code of the Library into a program that is not a library.

4. You may copy and distribute the Library (or a portion or derivative of it, under Section 2) in object code or executable form under the terms of Sections 1 and 2 above provided that you accompany it with the complete corresponding machine-readable source code, which must be distributed under the terms of Sections 1 and 2 above on a medium customarily used for software interchange.

If distribution of object code is made by offering access to copy from a designated place, then offering equivalent access to copy the source code from the same place satisfies the requirement to distribute the source code, even though third parties are not compelled to copy the source along with the object code.

5. A program that contains no derivative of any portion of the Library, but is designed to work with the Library by being compiled or linked with it, is called a "work that uses the Library". Such a work, in isolation, is not a derivative work of the Library, and therefore falls outside the scope of this License.

However, linking a "work that uses the Library" with the Library creates an executable that is a derivative of the Library (because it contains portions of the Library), rather than a "work that uses the library". The executable is therefore covered by this License. Section 6 states terms for distribution of such executables.

When a "work that uses the Library" uses material from a header file that is part of the Library, the object code for the work may be a derivative work of the Library even though the source code is not. Whether this is true is especially significant if the work can be linked without the Library, or if the work is itself a library. The threshold for this to be true is not precisely defined by law.

If such an object file uses only numerical parameters, data structure layouts and accessors, and small macros and small inline functions (ten lines or less in length), then the use of the object file is unrestricted, regardless of whether it is legally a derivative work. (Executables containing this object code plus portions of the Library will still fall under Section 6.)

Otherwise, if the work is a derivative of the Library, you may distribute the object code for the work under the terms of Section 6. Any executables containing that work also fall under Section 6, whether or not they are linked directly with the Library itself.

6. As an exception to the Sections above, you may also combine or link a "work that uses the Library" with the Library to produce a work containing portions of the Library, and distribute that work under terms of your choice, provided that the terms permit modification of the work for the customer's own use and reverse engineering for debugging such modifications.

You must give prominent notice with each copy of the work that the Library is used in it and that the Library and its use are covered by this License. You must supply a copy of this License. If the work during execution displays copyright notices, you must include the copyright notice for the Library among them, as well as a reference directing the user to the copy of this License. Also, you must do one of these things:

- 2) **a)** Accompany the work with the complete corresponding machine-readable source code for the Library including whatever changes were used in the work (which must be distributed under Sections 1 and 2 above); and, if the work is an executable linked with the Library, with the complete machine-readable "work that uses the Library", as object code and/or source code, so that the user can modify the Library and then relink to produce a modified executable containing the modified Library. (It is understood that the user who changes the contents of definitions files in the Library will not necessarily be able to recompile the application to use the modified definitions.)
- 2) **b)** Use a suitable shared library mechanism for linking with the Library. A suitable mechanism is one that (1) uses at run time a copy of the library already present on the user's computer system, rather than copying library functions into the executable, and (2) will operate properly with a modified version of the library, if the user installs one, as long as the modified version is interface-compatible with the version that the work was made with.
- 2) **c)** Accompany the work with a written offer, valid for at least three years, to give the same user the materials specified in Subsection 6a, above, for a charge no more than the cost of performing this distribution.
- 2) **d)** If distribution of the work is made by offering access to copy from a designated place, offer equivalent access to copy the above specified materials from the same place.
- 2) **e)** Verify that the user has already received a copy of these materials or that you have already sent this user a copy.

For an executable, the required form of the "work that uses the Library" must include any data and utility programs needed for reproducing the executable from it. However, as a special exception, the materials to be distributed need not include anything that is normally distributed (in either source or binary form) with the major components (compiler, kernel, and so on) of the operating system on which the executable runs, unless that component itself accompanies the executable.

It may happen that this requirement contradicts the license restrictions of other proprietary libraries that do not normally accompany the operating system. Such a contradiction means you cannot use both them and the Library together in an executable that you distribute.

7. You may place library facilities that are a work based on the Library side-by-side in a single library together with other library facilities not covered by this License, and distribute such a combined library, provided that the separate distribution of the work based on the Library and of the other library facilities is otherwise permitted, and provided that you do these two things:

- 2) **a)** Accompany the combined library with a copy of the same work based on the Library, uncombined with any other library facilities. This must be distributed under the terms of the Sections above.
- 2) **b)** Give prominent notice with the combined library of the fact that part of it is a work based on the Library, and explaining where to find the accompanying uncombined form of the same work.

8. You may not copy, modify, sublicense, link with, or distribute the Library except as expressly provided under this License. Any attempt otherwise to copy, modify, sublicense, link with, or distribute the Library is void, and will automatically terminate your rights under this License. However, parties who have received copies, or rights, from you under this License will not have their licenses terminated so long as such parties remain in full compliance.

9. You are not required to accept this License, since you have not signed it. However, nothing else grants you permission to modify or distribute the Library or its derivative works. These actions are prohibited by law if you do not accept this License. Therefore, by modifying or distributing the Library (or any work based on the Library), you indicate your acceptance of this License to do so, and

all its terms and conditions for copying, distributing or modifying the Library or works based on it.

10. Each time you redistribute the Library (or any work based on the Library), the recipient automatically receives a license from the original licensor to copy, distribute, link with or modify the Library subject to these terms and conditions. You may not impose any further restrictions on the recipients' exercise of the rights granted herein. You are not responsible for enforcing compliance by third parties with this License.

11. If, as a consequence of a court judgment or allegation of patent infringement or for any other reason (not limited to patent issues), conditions are imposed on you (whether by court order, agreement or otherwise) that contradict the conditions of this License, they do not excuse you from the conditions of this License. If you cannot distribute so as to satisfy simultaneously your obligations under this License and any other pertinent obligations, then as a consequence you may not distribute the Library at all. For example, if a patent license would not permit royalty-free redistribution of the Library by all those who receive copies directly or indirectly through you, then the only way you could satisfy both it and this License would be to refrain entirely from distribution of the Library.

If any portion of this section is held invalid or unenforceable under any particular circumstance, the balance of the section is intended to apply, and the section as a whole is intended to apply in other circumstances.

It is not the purpose of this section to induce you to infringe any patents or other property right claims or to contest validity of any such claims; this section has the sole purpose of protecting the integrity of the free software distribution system which is implemented by public license practices. Many people have made generous contributions to the wide range of software distributed through that system in reliance on consistent application of that system; it is up to the author/donor to decide if he or she is willing to distribute software through any other system and a licensee cannot impose that choice.

This section is intended to make thoroughly clear what is believed to be a consequence of the rest of this License.

12. If the distribution and/or use of the Library is restricted in certain countries either by patents or by copyrighted interfaces, the original copyright holder who places the Library under this License may add an explicit geographical distribution limitation excluding those countries, so that distribution is permitted only in or among countries not thus excluded. In such case, this License incorporates the limitation as if written in the body of this License.

13. The Free Software Foundation may publish revised and/or new versions of the Lesser General Public License from time to time. Such new versions will be similar in spirit to the present version, but may differ in detail to address new problems or concerns.

Each version is given a distinguishing version number. If the Library specifies a version number of this License which applies to it and "any later version", you have the option of following the terms and conditions either of that version or of any later version published by the Free Software Foundation. If the Library does not specify a license version number, you may choose any version ever published by the Free Software Foundation.

14. If you wish to incorporate parts of the Library into other free programs whose distribution conditions are incompatible with these, write to the author to ask for permission. For software which is copyrighted by the Free Software Foundation, write to the Free Software Foundation; we sometimes make exceptions for this. Our decision will be guided by the two goals of preserving the free status of all derivatives of our free software and of promoting the sharing and reuse of software generally.

NO WARRANTY

15. BECAUSE THE LIBRARY IS LICENSED FREE OF CHARGE, THERE IS NO WARRANTY FOR THE LIBRARY, TO THE EXTENT PERMITTED BY APPLICABLE LAW. EXCEPT WHEN OTHERWISE STATED IN WRITING THE COPYRIGHT HOLDERS AND/OR OTHER PARTIES PROVIDE THE LIBRARY "AS IS" WITHOUT WARRANTY OF ANY KIND, EITHER EXPRESSED OR IMPLIED, INCLUDING, BUT NOT LIMITED TO, THE IMPLIED WARRANTIES OF MERCHANTABILITY AND FITNESS FOR A PARTICULAR PURPOSE. THE ENTIRE RISK AS TO THE QUALITY AND PERFORMANCE OF THE LIBRARY IS WITH YOU. SHOULD THE LIBRARY PROVE DEFECTIVE, YOU ASSUME THE COST OF ALL NECESSARY SERVICING, REPAIR OR CORRECTION.

16. IN NO EVENT UNLESS REQUIRED BY APPLICABLE LAW OR AGREED TO IN WRITING WILL ANY COPYRIGHT HOLDER, OR ANY OTHER PARTY WHO MAY MODIFY AND/OR REDISTRIBUTE THE LIBRARY AS PERMITTED ABOVE, BE LIABLE TO YOU FOR DAMAGES, INCLUDING ANY GENERAL, SPECIAL, INCIDENTAL OR CONSEQUENTIAL DAMAGES ARISING OUT OF THE USE OR INABILITY TO USE THE LIBRARY (INCLUDING BUT NOT LIMITED TO LOSS OF DATA OR DATA BEING RENDERED INACCURATE OR LOSSES SUSTAINED BY YOU OR THIRD PARTIES OR A FAILURE OF THE LIBRARY TO OPERATE WITH ANY

OTHER SOFTWARE), EVEN IF SUCH HOLDER OR OTHER PARTY HAS BEEN ADVISED OF THE POSSIBILITY OF SUCH DAMAGES.

END OF TERMS AND CONDITIONS

How to Apply These Terms to Your New Libraries

If you develop a new library, and you want it to be of the greatest possible use to the public, we recommend making it free software that everyone can redistribute and change. You can do so by permitting redistribution under these terms (or, alternatively, under the terms of the ordinary General Public License).

To apply these terms, attach the following notices to the library. It is safest to attach them to the start of each source file to most effectively convey the exclusion of warranty; and each file should have at least the "copyright" line and a pointer to where the full notice is found.

one line to give the library's name and an idea of what it does.
Copyright (C) year name of author

This library is free software; you can redistribute it and/or modify it under the terms of the GNU Lesser General Public License as published by the Free Software Foundation; either version 2.1 of the License, or (at your option) any later version.

This library is distributed in the hope that it will be useful, but WITHOUT ANY WARRANTY; without even the implied warranty of MERCHANTABILITY or FITNESS FOR A PARTICULAR PURPOSE. See the GNU Lesser General Public License for more details.

You should have received a copy of the GNU Lesser General Public License along with this library; if not, write to the Free Software Foundation, Inc., 51 Franklin Street, Fifth Floor, Boston, MA 02110-1301 USA Also

add information on how to contact you by electronic and paper mail.

You should also get your employer (if you work as a programmer) or your school, if any, to sign a "copyright disclaimer" for the library, if necessary. Here is a sample; alter the names:

Yoyodyne, Inc., hereby disclaims all copyright interest in the library "Frob" (a library for tweaking knobs) written by James Random Hacker.

signature of Ty Coon, 1 April 1990
Ty Coon, President of Vice

That's all there is to it!

Apache License

Version 2.0, January 2004

<http://www.apache.org/licenses/>

TERMS AND CONDITIONS FOR USE, REPRODUCTION, AND DISTRIBUTION

1. Definitions.

"License" shall mean the terms and conditions for use, reproduction, and distribution as defined by Sections 1 through 9 of this document.

"Licensor" shall mean the copyright owner or entity authorized by the copyright owner that is granting the License.

"Legal Entity" shall mean the union of the acting entity and all other entities that control, are controlled by, or are under common control with that entity. For the purposes of this definition, "control" means (i) the power, direct or indirect, to cause the direction or management of such entity, whether by contract or otherwise, or (ii) ownership of fifty percent (50%) or more of the outstanding shares, or (iii) beneficial ownership of such entity.

"You" (or "Your") shall mean an individual or Legal Entity exercising permissions granted by this License.

"Source" form shall mean the preferred form for making modifications, including but not limited to software source code, documentation source, and configuration files.

"Object" form shall mean any form resulting from mechanical transformation or translation of a Source form, including but not limited to compiled object code, generated documentation, and conversions to other media types.

"Work" shall mean the work of authorship, whether in Source or Object form, made available under the License, as indicated by a copyright notice that is included in or attached to the work (an example is provided in the Appendix below).

"Derivative Works" shall mean any work, whether in Source or Object form, that is based on (or derived from) the Work and for which the editorial revisions, annotations, elaborations, or other modifications represent, as a whole, an original work of authorship. For the purposes of this License, Derivative Works shall not include works that remain separable from, or merely link (or bind by name) to the interfaces of, the Work and Derivative Works thereof.

"Contribution" shall mean any work of authorship, including the original version of the Work and any modifications or additions to that Work or Derivative Works thereof, that is intentionally submitted to Licensor for inclusion in the Work by the copyright owner or by an individual or Legal Entity authorized to submit on behalf of the copyright owner. For the purposes of this definition, "submitted" means any form of electronic, verbal, or written communication sent to the Licensor or its representatives, including but not limited to communication on electronic mailing lists, source code control systems, and issue tracking systems that are managed by, or on behalf of, the Licensor for the purpose of discussing and improving the Work, but excluding communication that is conspicuously marked or otherwise designated in writing by the copyright owner as "Not a Contribution."

"Contributor" shall mean Licensor and any individual or Legal Entity on behalf of whom a Contribution has been received by Licensor and subsequently incorporated within the Work.

2. Grant of Copyright License. Subject to the terms and conditions of this License, each Contributor hereby grants to You a perpetual, worldwide, non-exclusive, no-charge, royalty-free, irrevocable copyright license to reproduce, prepare Derivative Works of, publicly display, publicly perform, sublicense, and distribute the Work and such Derivative Works in Source or Object form.

3. Grant of Patent License. Subject to the terms and conditions of this License, each Contributor hereby grants to You a perpetual, worldwide, non-exclusive, no-charge, royalty-free, irrevocable (except as stated in this section) patent license to make, have made, use, offer to sell, sell, import, and otherwise transfer the Work, where such license applies only to those patent claims licensable by such Contributor that are necessarily infringed by their Contribution(s) alone or by combination of their Contribution(s) with the Work to which such Contribution(s) was submitted. If You institute patent litigation against any entity (including a cross-claim or counterclaim in a lawsuit) alleging that the Work or a Contribution incorporated within the Work constitutes direct or contributory patent infringement, then any patent licenses granted to You under this License for that Work shall terminate as of the date such litigation is filed.

4. Redistribution. You may reproduce and distribute copies of the Work or Derivative Works thereof in any medium, with or without modifications, and in Source or Object form, provided that You meet the following conditions:

1. You must give any other recipients of the Work or Derivative Works a copy of this License; and
2. You must cause any modified files to carry prominent notices stating that You changed the files; and
3. You must retain, in the Source form of any Derivative Works that You distribute, all copyright, patent, trademark, and attribution notices from the Source form of the Work, excluding those notices that do not pertain to any part of the Derivative Works; and
4. If the Work includes a "NOTICE" text file as part of its distribution, then any Derivative Works that You distribute must include a readable copy of the attribution notices contained within such NOTICE file, excluding those notices that do not pertain to any part of the Derivative Works, in at least one of the following places:
within a NOTICE text file distributed as part of the Derivative Works; within the Source form or documentation, if provided along with the Derivative Works; or, within a display generated by the Derivative Works, if and wherever such third-party notices normally appear. The contents of the NOTICE file are for informational purposes only and do not modify the License. You may add Your own attribution notices within Derivative Works that You distribute, alongside or as an addendum to the NOTICE text from the Work, provided that such additional attribution notices cannot be construed as modifying the License. You may add Your own copyright statement to Your modifications and may provide additional or different license terms and conditions for use, reproduction, or distribution of Your modifications, or for any such Derivative Works as a whole, provided Your use, reproduction, and

distribution of the Work otherwise complies with the conditions stated in this License.

5. Submission of Contributions. Unless You explicitly state otherwise, any Contribution intentionally submitted for inclusion in the Work by You to the Licensor shall be under the terms and conditions of this License, without any additional terms or conditions. Notwithstanding the above, nothing herein shall supersede or modify the terms of any separate license agreement you may have executed with Licensor regarding such Contributions.

6. Trademarks. This License does not grant permission to use the trade names, trademarks, service marks, or product names of the Licensor, except as required for reasonable and customary use in describing the origin of the Work and reproducing the content of the NOTICE file.

7. Disclaimer of Warranty. Unless required by applicable law or agreed to in writing, Licensor provides the Work (and each Contributor provides its Contributions) on an "AS IS" BASIS, WITHOUT WARRANTIES OR CONDITIONS OF ANY KIND, either express or implied, including, without limitation, any warranties or conditions of TITLE, NON-INFRINGEMENT, MERCHANTABILITY, or FITNESS FOR A PARTICULAR PURPOSE. You are solely responsible for determining the appropriateness of using or redistributing the Work and assume any risks associated with Your exercise of permissions under this License.

8. Limitation of Liability. In no event and under no legal theory, whether in tort (including negligence), contract, or otherwise, unless required by applicable law (such as deliberate and grossly negligent acts) or agreed to in writing, shall any Contributor be liable to You for damages, including any direct, indirect, special, incidental, or consequential damages of any character arising as a result of this License or out of the use or inability to use the Work (including but not limited to damages for loss of goodwill, work stoppage, computer failure or malfunction, or any and all other commercial damages or losses), even if such Contributor has been advised of the possibility of such damages.

9. Accepting Warranty or Additional Liability. While redistributing the Work or Derivative Works thereof, You may choose to offer, and charge a fee for, acceptance of support, warranty, indemnity, or other liability obligations and/or rights consistent with this License. However, in accepting such obligations, You may act only on Your own behalf and on Your sole responsibility, not on behalf of any other Contributor, and only if You agree to indemnify, defend, and hold each Contributor harmless for any liability incurred by, or claims asserted against, such Contributor by reason of your accepting any such warranty or additional liability.

END OF TERMS AND CONDITIONS

APPENDIX: How to apply the Apache License to your work

To apply the Apache License to your work, attach the following boilerplate notice, with the fields enclosed by brackets "[]" replaced with your own identifying information. (Don't include the brackets!) The text should be enclosed in the appropriate comment syntax for the file format. We also recommend that a file or class name and description of purpose be included on the same "printed page" as the copyright notice for easier identification within third-party archives.

Copyright [yyyy] [name of copyright owner]

Licensed under the Apache License, Version 2.0 (the "License"); you may not use this file except in compliance with the License. You may obtain a copy of the License at

<http://www.apache.org/licenses/LICENSE-2.0>

Unless required by applicable law or agreed to in writing, software distributed under the License is distributed on an "AS IS" BASIS, WITHOUT WARRANTIES OR CONDITIONS OF ANY KIND, either express or implied.

See the License for the specific language governing permissions and limitations under the License.

ash license:

Copyright (c) 1989, 1991, 1993, 1994 The Regents of the University of California. All rights reserved.

This code is derived from software contributed to Berkeley by Kenneth Almquist

Redistribution and use in source and binary forms, with or without modification, are permitted provided that the following conditions are met:

1. Redistributions of source code must retain the above copyright notice, this list of conditions and the following disclaimer.
2. Redistributions in binary form must reproduce the above copyright notice, this list of conditions and the following disclaimer in the documentation and/or other materials provided with the distribution.
3. Neither the name of the University nor the names of its contributors may be used to endorse or promote products derived from this software without specific prior written permission.

THIS SOFTWARE IS PROVIDED BY THE REGENTS AND CONTRIBUTORS "AS IS" AND ANY EXPRESS OR IMPLIED WARRANTIES, INCLUDING, BUT NOT LIMITED TO, THE IMPLIED WARRANTIES OF MERCHANTABILITY AND FITNESS FOR A PARTICULAR PURPOSE ARE DISCLAIMED. IN NO EVENT SHALL THE REGENTS OR CONTRIBUTORS BE LIABLE FOR ANY DIRECT, INDIRECT, INCIDENTAL, SPECIAL, EXEMPLARY, OR CONSEQUENTIAL DAMAGES (INCLUDING, BUT NOT LIMITED TO, PROCUREMENT OF SUBSTITUTE GOODS OR SERVICES; LOSS OF USE, DATA, OR PROFITS; OR BUSINESS INTERRUPTION) HOWEVER CAUSED AND ON ANY THEORY OF LIABILITY, WHETHER IN CONTRACT, STRICT LIABILITY, OR TORT (INCLUDING NEGLIGENCE OR OTHERWISE) ARISING IN ANY WAY OUT OF THE USE OF THIS SOFTWARE, EVEN IF ADVISED OF THE POSSIBILITY OF SUCH DAMAGE.

miniupnpc license:

Copyright (c) 2005-2009, Thomas BERNARD All rights reserved.

Redistribution and use of this software in source and binary forms, with or without modification, are permitted provided that the following conditions are met:

2. Redistributions of source code must retain the above copyright notice, this list of conditions and the following disclaimer.
2. Redistributions in binary form must reproduce the above copyright notice, this list of conditions and the following disclaimer in the documentation and/or other materials provided with the distribution.
2. Neither the name of the author may be used to endorse or promote products derived from this software without specific prior written permission.

THIS SOFTWARE IS PROVIDED BY THE COPYRIGHT HOLDERS AND CONTRIBUTORS "AS IS" AND ANY EXPRESS OR IMPLIED WARRANTIES, INCLUDING, BUT NOT LIMITED TO, THE IMPLIED WARRANTIES OF MERCHANTABILITY AND FITNESS FOR A PARTICULAR PURPOSE ARE DISCLAIMED. IN NO EVENT SHALL THE COPYRIGHT OWNER OR CONTRIBUTORS BE LIABLE FOR ANY DIRECT, INDIRECT, INCIDENTAL, SPECIAL, EXEMPLARY, OR CONSEQUENTIAL DAMAGES (INCLUDING, BUT NOT LIMITED TO, PROCUREMENT OF SUBSTITUTE GOODS OR SERVICES; LOSS OF USE, DATA, OR PROFITS; OR BUSINESS INTERRUPTION) HOWEVER CAUSED AND ON ANY THEORY OF LIABILITY, WHETHER IN CONTRACT, STRICT LIABILITY, OR TORT (INCLUDING NEGLIGENCE OR OTHERWISE) ARISING IN ANY WAY OUT OF THE USE OF THIS SOFTWARE, EVEN IF ADVISED OF THE POSSIBILITY OF SUCH DAMAGE.

telnet-server license:

Copyright (c) 1989 Regents of the University of California. All rights reserved.

Redistribution and use in source and binary forms, with or without modification, are permitted provided that the following conditions are met:

1. Redistributions of source code must retain the above copyright notice, this list of conditions and the following disclaimer.
2. Redistributions in binary form must reproduce the above copyright notice, this list of conditions and the following disclaimer in the documentation and/or other materials provided with the distribution.
3. All advertising materials mentioning features or use of this software must display the following acknowledgement:
This product includes software developed by the University of California, Berkeley and its contributors.
4. Neither the name of the University nor the names of its contributors may be used to endorse or promote products derived from this software without specific prior written permission.

THIS SOFTWARE IS PROVIDED BY THE REGENTS AND CONTRIBUTORS "AS IS" AND ANY EXPRESS OR IMPLIED WARRANTIES, INCLUDING, BUT NOT LIMITED TO, THE IMPLIED WARRANTIES OF MERCHANTABILITY AND FITNESS FOR A PARTICULAR PURPOSE ARE DISCLAIMED. IN NO EVENT SHALL THE REGENTS OR CONTRIBUTORS BE LIABLE FOR ANY DIRECT, INDIRECT, INCIDENTAL, SPECIAL, EXEMPLARY, OR CONSEQUENTIAL DAMAGES (INCLUDING, BUT NOT LIMITED TO, PROCUREMENT OF SUBSTITUTE GOODS OR SERVICES; LOSS OF USE, DATA, OR PROFITS; OR BUSINESS INTERRUPTION) HOWEVER CAUSED AND ON ANY THEORY OF LIABILITY, WHETHER IN CONTRACT, STRICT LIABILITY, OR TORT (INCLUDING NEGLIGENCE OR OTHERWISE) ARISING IN ANY WAY OUT OF THE USE OF THIS SOFTWARE, EVEN IF ADVISED OF THE POSSIBILITY OF SUCH DAMAGE.

YUI License:

Copyright (c) 2011, Yahoo! Inc. All rights reserved.

Redistribution and use of this software in source and binary forms, with or without modification, are permitted provided that the following conditions are met:

2. Redistributions of source code must retain the above copyright notice, this list of conditions and the following disclaimer.
2. Redistributions in binary form must reproduce the above copyright notice, this list of conditions and the following disclaimer in the documentation and/or other materials provided with the distribution.
2. Neither the name of Yahoo! Inc. nor the names of its contributors may be used to endorse or promote products derived from this software without specific prior written permission of Yahoo! Inc.

THIS SOFTWARE IS PROVIDED BY THE COPYRIGHT HOLDERS AND CONTRIBUTORS "AS IS" AND ANY EXPRESS OR IMPLIED WARRANTIES, INCLUDING, BUT NOT LIMITED TO, THE IMPLIED WARRANTIES OF MERCHANTABILITY AND FITNESS FOR A PARTICULAR PURPOSE ARE DISCLAIMED. IN NO EVENT SHALL THE COPYRIGHT OWNER OR CONTRIBUTORS BE LIABLE FOR ANY DIRECT, INDIRECT, INCIDENTAL, SPECIAL, EXEMPLARY, OR CONSEQUENTIAL DAMAGES (INCLUDING, BUT NOT LIMITED TO, PROCUREMENT OF SUBSTITUTE GOODS OR SERVICES; LOSS OF USE, DATA, OR PROFITS; OR BUSINESS INTERRUPTION) HOWEVER CAUSED AND ON ANY THEORY OF LIABILITY, WHETHER IN CONTRACT, STRICT LIABILITY, OR TORT (INCLUDING NEGLIGENCE OR OTHERWISE) ARISING IN ANY WAY OUT OF THE USE OF THIS SOFTWARE, EVEN IF ADVISED OF THE POSSIBILITY OF SUCH DAMAGE.

ppp license:

Copyright (c) 1993 The Australian National University. All rights reserved.

Redistribution and use in source and binary forms are permitted provided that the above copyright notice and this paragraph are duplicated in all such forms and that any documentation, advertising materials, and other materials related to such distribution and use acknowledge that the software was developed by the Australian National University. The name of the University may not be used to endorse or promote products derived from this software without specific prior written permission.

THIS SOFTWARE IS PROVIDED "AS IS" AND WITHOUT ANY EXPRESS OR IMPLIED WARRANTIES, INCLUDING, WITHOUT LIMITATION, THE IMPLIED WARRANTIES OF MERCHANTABILITY AND FITNESS FOR A PARTICULAR PURPOSE.

Copyright (c) 1989 Carnegie Mellon University. All rights reserved.

Redistribution and use in source and binary forms are permitted provided that the above copyright notice and this paragraph are duplicated in all such forms and that any documentation, advertising materials, and other materials related to such distribution and use acknowledge that the software was developed by Carnegie Mellon University. The name of the University may not be used to endorse or promote products derived from this software without specific prior written permission. THIS SOFTWARE IS PROVIDED "AS IS" AND WITHOUT ANY EXPRESS OR IMPLIED WARRANTIES, INCLUDING, WITHOUT LIMITATION, THE IMPLIED WARRANTIES OF MERCHANTABILITY AND FITNESS FOR A PARTICULAR PURPOSE.

c-res license:

Copyright 1998 by the Massachusetts Institute of Technology.

Permission to use, copy, modify, and distribute this software and its documentation for any purpose and without fee is hereby granted, provided that the above copyright notice appear in all copies and that both that copyright notice and this permission notice appear in supporting documentation, and that the name of M.I.T. not be used in advertising or publicity pertaining to distribution of the software without specific, written prior permission.

M.I.T. makes no representations about the suitability of this software for any purpose. It is provided "as is" without express or implied warranty.

curl license:

Copyright (c) 1996 - 2010, Daniel Stenberg, <daniel@haxx.se>. All rights reserved.

Permission to use, copy, modify, and distribute this software for any purpose with or without fee is hereby granted, provided that the above copyright notice and this permission notice appear in all copies.

THE SOFTWARE IS PROVIDED "AS IS", WITHOUT WARRANTY OF ANY KIND, EXPRESS OR IMPLIED, INCLUDING BUT NOT LIMITED TO THE WARRANTIES OF MERCHANTABILITY, FITNESS FOR A PARTICULAR PURPOSE AND NONINFRINGEMENT OF THIRD PARTY RIGHTS. IN NO EVENT SHALL THE AUTHORS OR COPYRIGHT HOLDERS BE LIABLE FOR ANY CLAIM, DAMAGES OR OTHER LIABILITY, WHETHER IN AN ACTION OF CONTRACT, TORT OR

OTHERWISE, ARISING FROM, OUT OF OR IN CONNECTION WITH THE SOFTWARE OR THE USE OR OTHER DEALINGS IN THE SOFTWARE.

Except as contained in this notice, the name of a copyright holder shall not be used in advertising or otherwise to promote the sale, use or other dealings in this Software without prior written authorization of the copyright holder.

liboauth license:

Copyright 2007, 2008 Robin Gareus <robin@gareus.org>

Unless otherwise indicated, Source Code is licensed under MIT license. Permission is

hereby granted, free of charge, to any person obtaining a copy of this software and associated documentation files (the "Software"), to deal in the Software without restriction, including without limitation the rights to use, copy, modify, merge, publish, distribute, sublicense, and/or sell copies of the Software, and to permit persons to whom the Software is furnished to do so, subject to the following conditions:

The above copyright notice and this permission notice shall be included in all copies or substantial portions of the Software.

THE SOFTWARE IS PROVIDED "AS IS", WITHOUT WARRANTY OF ANY KIND, EXPRESS OR IMPLIED, INCLUDING BUT NOT LIMITED TO THE WARRANTIES OF MERCHANTABILITY, FITNESS FOR A PARTICULAR PURPOSE AND NONINFRINGEMENT. IN NO EVENT SHALL THE AUTHORS OR COPYRIGHT HOLDERS BE LIABLE FOR ANY CLAIM, DAMAGES OR OTHER LIABILITY, WHETHER IN AN ACTION OF CONTRACT, TORT OR OTHERWISE, ARISING FROM, OUT OF OR IN CONNECTION WITH THE SOFTWARE OR THE USE OR OTHER DEALINGS IN THE SOFTWARE.

jpeg license:

Copyright (c) 2011 The jpeg project. <<http://code.google.com/p/jpeg/>>

Permission is hereby granted, free of charge, to any person obtaining a copy of this software and associated documentation files (the "Software"), to deal in the Software without restriction, including without limitation the rights to use, copy, modify, merge, publish, distribute, sublicense, and/or sell copies of the Software, and to permit persons to whom the Software is furnished to do so, subject to the following conditions:

The above copyright notice and this permission notice shall be included in all copies or substantial portions of the Software.

THE SOFTWARE IS PROVIDED "AS IS", WITHOUT WARRANTY OF ANY KIND, EXPRESS OR IMPLIED, INCLUDING BUT NOT LIMITED TO THE WARRANTIES OF MERCHANTABILITY, FITNESS FOR A PARTICULAR PURPOSE AND NONINFRINGEMENT. IN NO EVENT SHALL THE AUTHORS OR COPYRIGHT HOLDERS BE LIABLE FOR ANY CLAIM, DAMAGES OR OTHER LIABILITY, WHETHER IN AN ACTION OF CONTRACT, TORT OR OTHERWISE, ARISING FROM, OUT OF OR IN CONNECTION WITH THE SOFTWARE OR THE USE OR OTHER DEALINGS IN THE SOFTWARE.

OpenSSL License:

Copyright (c) 1998-2011 The OpenSSL Project. All rights reserved.

Redistribution and use in source and binary forms, with or without modification, are permitted provided that the following conditions are met:

1. Redistributions of source code must retain the above copyright notice, this list of conditions and the following disclaimer.
2. Redistributions in binary form must reproduce the above copyright notice, this list of conditions and the following disclaimer in the documentation and/or other materials provided with the distribution.
3. All advertising materials mentioning features or use of this software must display the following acknowledgment:
"This product includes software developed by the OpenSSL Project for use in the OpenSSL Toolkit. (<http://www.openssl.org/>)"
4. The names "OpenSSL Toolkit" and "OpenSSL Project" must not be used to endorse or promote products derived from this software without prior written permission. For written permission, please contact openssl-core@openssl.org.
5. Products derived from this software may not be called "OpenSSL" nor may "OpenSSL" appear in their names without prior written permission of the OpenSSL Project.
6. Redistributions of any form whatsoever must retain the following acknowledgment:
"This product includes software developed by the OpenSSL Project for use in the OpenSSL Toolkit (<http://www.openssl.org/>)"

THIS SOFTWARE IS PROVIDED BY THE OPENSSL PROJECT "AS IS" AND ANY EXPRESSED OR IMPLIED WARRANTIES, INCLUDING, BUT NOT LIMITED TO, THE IMPLIED WARRANTIES OF MERCHANTABILITY AND FITNESS FOR A PARTICULAR PURPOSE ARE DISCLAIMED. IN NO EVENT SHALL THE OPENSSL PROJECT OR ITS CONTRIBUTORS BE LIABLE FOR ANY DIRECT, INDIRECT, INCIDENTAL, SPECIAL, EXEMPLARY, OR CONSEQUENTIAL DAMAGES (INCLUDING, BUT NOT LIMITED TO, PROCUREMENT OF SUBSTITUTE GOODS OR SERVICES; LOSS OF USE, DATA, OR PROFITS; OR BUSINESS INTERRUPTION) HOWEVER CAUSED AND ON ANY THEORY OF LIABILITY, WHETHER IN CONTRACT, STRICT LIABILITY, OR TORT (INCLUDING NEGLIGENCE OR

OTHERWISE) ARISING IN ANY WAY OUT OF THE USE OF THIS SOFTWARE, EVEN IF ADVISED OF THE POSSIBILITY OF SUCH DAMAGE.

This product includes cryptographic software written by Eric Young (ey@cryptsoft.com). This product includes software written by Tim Hudson (tjh@cryptsoft.com).

Original SSL/leay License

Copyright (C) 1995-1998 Eric Young (ey@cryptsoft.com) All rights reserved.

This package is an SSL implementation written by Eric Young (ey@cryptsoft.com).

The implementation was written so as to conform with Netscape's SSL.

This library is free for commercial and non-commercial use as long as the following conditions are aheared to. The following conditions apply to all code found in this distribution, be it the RC4, RSA, lhash, DES, etc. code; not just the SSL code. The SSL documentation included with this distribution is covered by the same copyright terms except that the holder is Tim Hudson (tjh@cryptsoft.com).

Copyright remains Eric Young's, and as such any Copyright notices in the code are not to be removed.

If this package is used in a product, Eric Young should be given attribution as the author of the parts of the library used. This can be in the form of a textual message at program startup or in documentation (online or textual) provided with the package.

Redistribution and use in source and binary forms, with or without modification, are permitted provided that the following conditions are met:

1. Redistributions of source code must retain the copyright notice, this list of conditions and the following disclaimer.
2. Redistributions in binary form must reproduce the above copyright notice, this list of conditions and the following disclaimer in the documentation and/or other materials provided with the distribution.
3. All advertising materials mentioning features or use of this software must display the following acknowledgement:
"This product includes cryptographic software written by Eric Young (ey@cryptsoft.com)"
The word 'cryptographic' can be left out if the routines from the library being used are not cryptographic related :-).
4. If you include any Windows specific code (or a derivative thereof) from the apps directory (application code) you must include an acknowledgement: "This product includes software written by Tim Hudson (tjh@cryptsoft.com)"

THIS SOFTWARE IS PROVIDED BY ERIC YOUNG "AS IS" AND ANY EXPRESS OR IMPLIED WARRANTIES, INCLUDING, BUT NOT LIMITED TO, THE IMPLIED WARRANTIES OF MERCHANTABILITY AND FITNESS FOR A PARTICULAR PURPOSE ARE DISCLAIMED. IN NO EVENT SHALL THE AUTHOR OR CONTRIBUTORS BE LIABLE FOR ANY DIRECT, INDIRECT, INCIDENTAL, SPECIAL, EXEMPLARY, OR CONSEQUENTIAL DAMAGES (INCLUDING, BUT NOT LIMITED TO, PROCUREMENT OF SUBSTITUTE GOODS OR SERVICES; LOSS OF USE, DATA, OR PROFITS; OR BUSINESS INTERRUPTION) HOWEVER CAUSED AND ON ANY THEORY OF LIABILITY, WHETHER IN CONTRACT, STRICT LIABILITY, OR TORT (INCLUDING NEGLIGENCE OR OTHERWISE) ARISING IN ANY WAY OUT OF THE USE OF THIS SOFTWARE, EVEN IF ADVISED OF THE POSSIBILITY OF SUCH DAMAGE.

The licence and distribution terms for any publically available version or derivative of this code cannot be changed. i.e. this code cannot simply be copied and put under another distribution licence [including the GNU Public Licence.]

SIL OPEN FONT LICENSE

Version 1.1 - 26 February 2007

PREAMBLE

The goals of the Open Font License (OFL) are to stimulate worldwide development of collaborative font projects, to support the font creation efforts of academic and linguistic communities, and to provide a free and open framework in which fonts may be shared and improved in partnership with others.

The OFL allows the licensed fonts to be used, studied, modified and redistributed freely as long as they are not sold by themselves. The fonts, including any derivative works, can be bundled, embedded, redistributed and/or sold with any software provided that any reserved names are not used by derivative works. The fonts and derivatives, however, cannot be released under any other type of license. The requirement for fonts to remain under this license does not apply to any document created using the fonts or their derivatives.

DEFINITIONS

"Font Software" refers to the set of files released by the Copyright Holder(s) under this license and clearly marked as such. This may include source files, build scripts and documentation.

"Reserved Font Name" refers to any names specified as such after the copyright statement(s).

"Original Version" refers to the collection of Font Software components as distributed by the Copyright Holder(s).

"Modified Version" refers to any derivative made by adding to, deleting, or substituting — in part or in whole — any of the components of the Original Version, by changing formats or by porting the Font Software to a new environment.

"Author" refers to any designer, engineer, programmer, technical writer or other person who contributed to the Font Software.

PERMISSION & CONDITIONS

Permission is hereby granted, free of charge, to any person obtaining a copy of the Font Software, to use, study, copy, merge, embed, modify, redistribute, and sell modified and unmodified copies of the Font Software, subject to the following conditions:

- 1) Neither the Font Software nor any of its individual components, in Original or Modified Versions, may be sold by itself.
- 2) Original or Modified Versions of the Font Software may be bundled, redistributed and/or sold with any software, provided that each copy contains the above copyright notice and this license. These can be included either as stand- alone text files, human-readable headers or in the appropriate machine- readable metadata fields within text or binary files as long as those fields can be easily viewed by the user.
- 3) No Modified Version of the Font Software may use the Reserved Font Name(s) unless explicit written permission is granted by the corresponding Copyright Holder. This restriction only applies to the primary font name as presented to the users.
- 4) The name(s) of the Copyright Holder(s) or the Author(s) of the Font Software shall not be used to promote, endorse or advertise any Modified Version, except to acknowledge the contribution(s) of the Copyright Holder(s) and the Author(s) or with their explicit written permission.
- 5) The Font Software, modified or unmodified, in part or in whole, must be distributed entirely under this license, and must not be distributed under any other license. The requirement for fonts to remain under this license does not apply to any document created using the Font Software.

TERMINATION

This license becomes null and void if any of the above conditions are not met.

DISCLAIMER

THE FONT SOFTWARE IS PROVIDED "AS IS", WITHOUT WARRANTY OF ANY KIND, EXPRESS OR IMPLIED, INCLUDING BUT NOT LIMITED TO ANY WARRANTIES OF MERCHANTABILITY, FITNESS FOR A PARTICULAR PURPOSE AND NONINFRINGEMENT OF COPYRIGHT, PATENT, TRADEMARK, OR OTHER RIGHT. IN NO EVENT SHALL THE COPYRIGHT HOLDER BE LIABLE FOR ANY CLAIM, DAMAGES OR OTHER LIABILITY, INCLUDING ANY GENERAL, SPECIAL, INDIRECT, INCIDENTAL, OR CONSEQUENTIAL DAMAGES, WHETHER IN AN ACTION OF CONTRACT, TORT OR OTHERWISE, ARISING FROM, OUT OF THE USE OR INABILITY TO USE THE FONT SOFTWARE OR FROM OTHER DEALINGS IN THE FONT SOFTWARE.