

HITACHI

These products are manufactured at a factory which has received quality control system certification in accordance with the ISO international standards.



CERTIFICATE No.
JMI-0062
ISO 9001-1994
BS EN ISO9001:1994
EN-ISO 9001-1994
JIS Z9901-1994

Remote Head 3CCD Color Camera

HV-D27 (1/2 inch CCD)

HV-D37 (1/3 inch CCD)

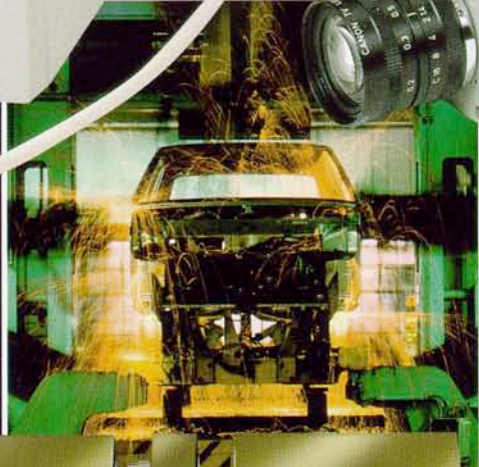

DIGITAL



Remote head camera featuring a new single chip VLSI, Digital Signal Processor (DSP), 3 CCD prism technology and C mount optics. Broadcast quality circuits and digital-processing technology is incorporated to provide high picture quality, excellent performance and outstanding stability.

HV-D27 (1/2 inch CCD)

HV-D37 (1/3 inch CCD)

The HV-D27/D37 from Hitachi is a separate head 3 CCD type color camera with a compact and lightweight camera control unit (CCU). The HV-D27 features 1/2-inch format CCD's while the HV-D37 uses 1/3-inch CCD's. Each CCD contains 410,000 (470,000 PAL) picture elements (pixels). The C mount lens fitting provides convenient physical compatibility with a broad selection of readily available and specialized optical systems. For improved performance and reliability, the CCU circuitry from the processor to the encoder is contained in a single VLSI DSP semiconductor chip. The small and lightweight head makes this camera an excellent choice for medical systems, industrial automation, image processing, microscope equipment and a nearly unlimited range of other applications.

Major Features

●C Mount

Select a lens designed for a prism to match the pickup element size.

HV-D27 : 1/2-inch prism type lens

HV-D37 : 1/3-inch prism type lens

Caution : Observe the dimensions of the lens mounting section as illustrated at the left. If the dimensions are not observed, do not use such a lens, because the lens and the camera will be damaged.

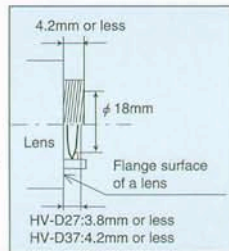

●One-Chip VLSI

Thanks to the state-of-the-art digital signal processing technology (0.5 micron processing), all signal processing from the processor section through the encoder section is accomplished within a single-chip VLSI (230,000-gates). In the development of this device careful consideration was given to lowering power consumption and minimizing the size of the device. The high signal-to-noise ratio and wide dynamic range of this device are complimented with a 10-bit A/D converter and 13-bit to 18-bit internal digital signal processing.



●High Resolution

The three 1/2-inch or 1/3-inch , 410,000-pixels NTSC (470,000-pixels PAL), CCD's feature a double sampled aperture circuit that along with digital processing provide 800 TV lines (HV-D27) , 750 TV lines (HV-D37) of resolution. High sensitivity is also assured with the micro-lens CCD technology.

●Easy CCD maintenance

Hitachi uses a special solder mounting technique to make possible the replacement of a single CCD rather than require the costly replacement of the entire CCD/prism assembly.

●High Signal-To-Noise Ratio

Thanks to the new digital noise reduction system (DNR), a signal-to-noise ratio of 62dB NTSC, 60dB PAL(HV-D27), 60dB NTSC, 58dB PAL(HV-D37) is assured. This provides a sharp, clear picture with less noise even in extreme high gain modes.

●Minimum Illumination of 1.5 (2.8) lux

The high sensitivity of the CCD's provides a standard sensitivity of f8.0 at 2000lx. Adding +20dB high gain along with ultra gain allow operation down to an illumination level of just 1.5lx (HV-D27) , 2.8lx (HV-D37). This high sensitivity and digital noise reduction allow video capture under the most adverse conditions, conditions impossible with conventional CCD cameras.

●Digital Noise Reduction (DNR)

Two modes of digital noise reduction can be selected to reduce the effects of noise that is common when using high gain.

●Ultra Gain

When selected, ultra gain adds an additional 12dB of gain to the camera by using a two pixel binning technique that increases gain without the addition of the corresponding amount of noise. When selected, ultra gain can increase the normal gain range from 20dB to 32dB.

●White Balance

Three modes of white balance can be selected. The auto mode enables the auto tracking white balance to maintain proper white balance with changing color temperature. The memory mode will automatically adjust white balance when the AWB button is pushed. A preset mode is factory set for 3200 degrees K.

●Color correction (Masking)

A six vector color corrector can be selected allowing the user to independently adjust the hue and saturation of the three primary and three complimentary colors. This feature can be used to precisely match cameras, or to paint individual scene objects.

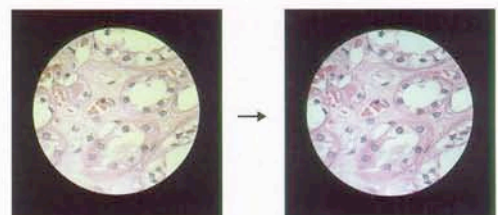



●Dyna Chroma

A new dyna chroma circuit maintains chroma detail in bright highly saturated colors, providing a more realistic reproduction of the objects being imaged.

●Chroma Gain

A 256 step chroma gain control allows overall adjustment of chroma without affecting the amount of chroma on the color bar output.

●Contrast

A two step contrast selection provides a boost in dark areas of the image, enhancing the detail and separation of dark objects.

●Auto Knee

An auto knee circuit can be selected allowing variable compression of bright objects that would otherwise be in the clip range of the camera. This makes it possible to shoot an object against a bright background such as a window, maintaining detail in objects inside and outside the window. Auto knee increases the dynamic range of the camera by approximately 300%.

●Auto Shading

Automatic shading corrects for chromatic aberrations (color fringing at the top and bottom of the screen) that result between interactions of the lens and the camera optics.

●Detail

Detail level and center frequency are adjustable, allowing the user to select the proper detail setting to suit the scene being imaged. A 256 step detail adjustment provides repeatability, while matching the fine adjustment range associated with a linear pot.



●Intelligent ALC

Automatic light control is done through a 64 segment (8 by 8) sensing area in conjunction with automatic gain control (AGC) and auto electronic shutter (AES). The digital system responds to wide variations of incident light.

The light sensing area can be selected in 5 preset patterns and 2 freely settable user memory according to the scene. The ALC level and response can also be set for peak or average to enable optimum quality image reproduction.

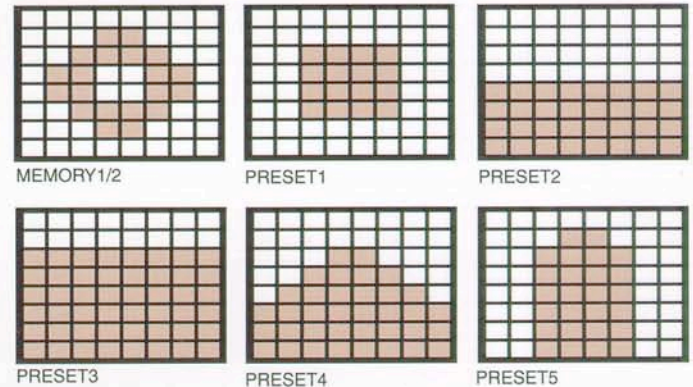

●Scene Files

The Camera features three scene files that can store user selected setup information. Switching between scene files results in each menu item being reset according to the information previously stored in the scene file.

●Multiple Shutter Operation

A standard electronic shutter mode can be selected in seven steps from 1/100 to 1/10,000 seconds. A lock scan mode used for imaging computer monitors allows a variable selection of shutter speeds from 1/60.38 to 1/251.5 in 1H steps. For use in medical or microscope applications, the camera can be set to a long term integration mode. In this mode the integration period can be selected in one frame increments from 1/30 to 8 seconds. Field or frame integration time can be controlled by an external trigger signal. An external memory or frame grabber is required.

Pin arrangement

D-sub connector (SDEB-9S)

Pin No.	Signal name
1	GND
2	WE
3	R/R-Y/C OUT
4	G/Y OUT
5	B/B-Y OUT
6	VBS OUT
7	SYNC OUT
8	HD OUT
9	VD OUT

TRIG connector (HR-10A-10R-12PB)

Pin No.	Signal name
1	GND
2	NC
3	NC
4	NC
5	GND
6	HD IN
7	VD IN/EXT TRIG IN
8	NC
9	NC
10	GND
11	NC
12	GND

●REMOTE connector (HR10A-7R-4S)

Pin No.	Signal
1	UNREG +12
2	RXD/SD IN
3	TXD/SD OUT
4	GND

●Y/C connector

Pin No.	Signal
1	Y GND
2	C GND
3	Y output
4	C output

●12V IN connector (Plug:RM12BPG-3S)

Pin No.	Signal
1	+12V output
2	GND
3	NC

1. Long trigger (filed) mode

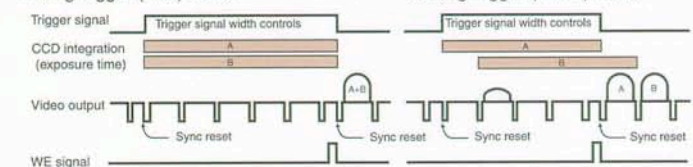

2. Long trigger (frame) mode

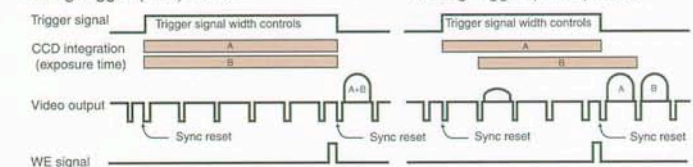

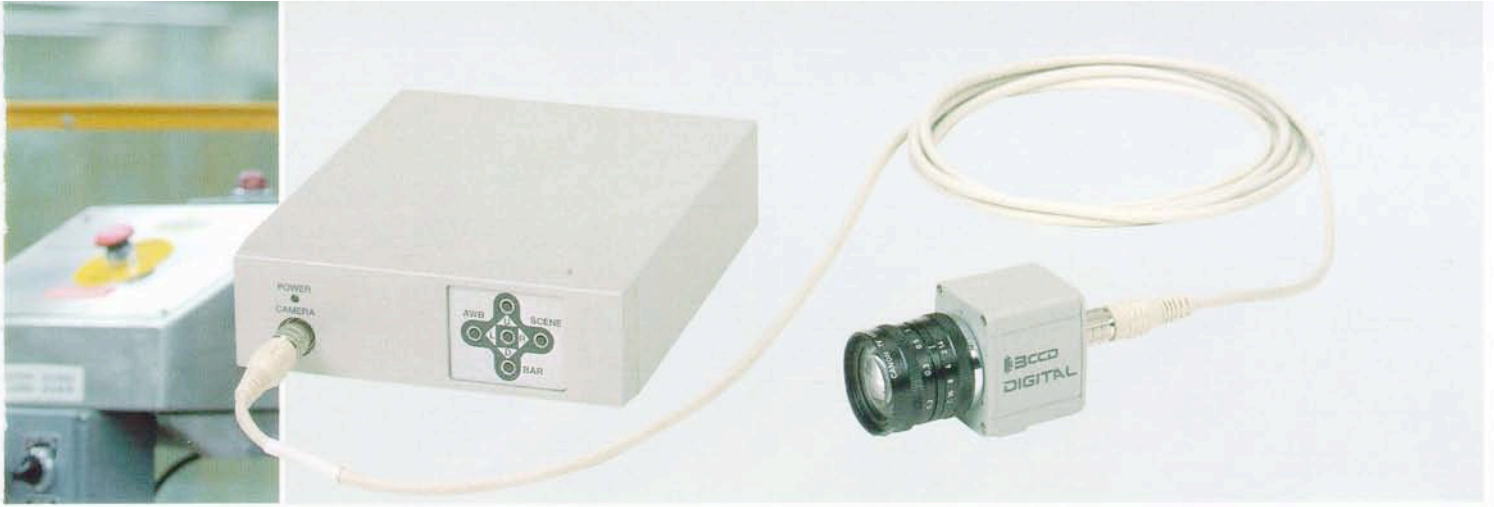

●Field on demand

An external trigger signal can be used to obtain a field image at a desired timing and exposure time. When the camera equipped with this function is used for industrial automation systems or image processing systems, high resolution color images with superb color reproduction can be analyzed. (External memory is *required for continuous images.)

1. Short trigger mode

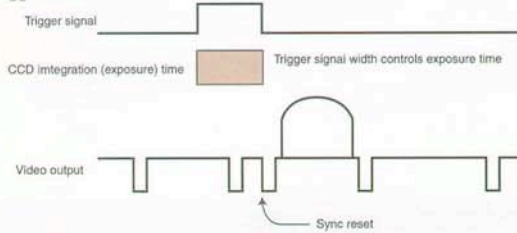

2. Fixed trigger mode

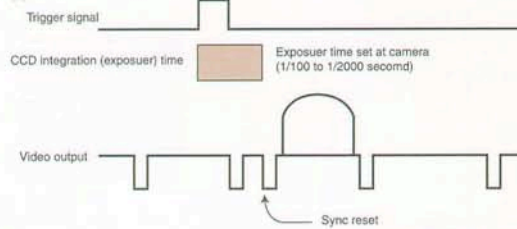

●Multiple Output Encoder

A multiple output encoder is used to provide a standard composite output along with a Y/C output. Additionally a component output is available on the D sub 9 connector, that can be selected between RGB, Y/ R-Y/ B-Y, or Y/C. A composite sync output along with H and V drive outputs are also provided on the D sub 9 connector.

●Genlock

A composite video signal or a black burst signal can be supplied as a reference for the genlock circuit. For industrial automation or image processing systems, the external reference mode can be selected to use external horizontal and vertical drive signals.

●Character Generator

Scene identifications or camera locations can be displayed along with the output video using the built in character generator. A separate camera ID number can also be displayed. The position of both displays can be selected to appear on the top or bottom of the screen.

●RS-232C Interface

A variety of camera functions can be controlled from a PC via the RS-232C interface for remote control. For further flexibility, the camera data can also be transferred to the PC for storage and later recall.

Functions menu

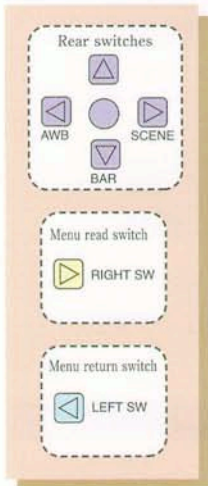

Digital process functions can be set on each menu screen

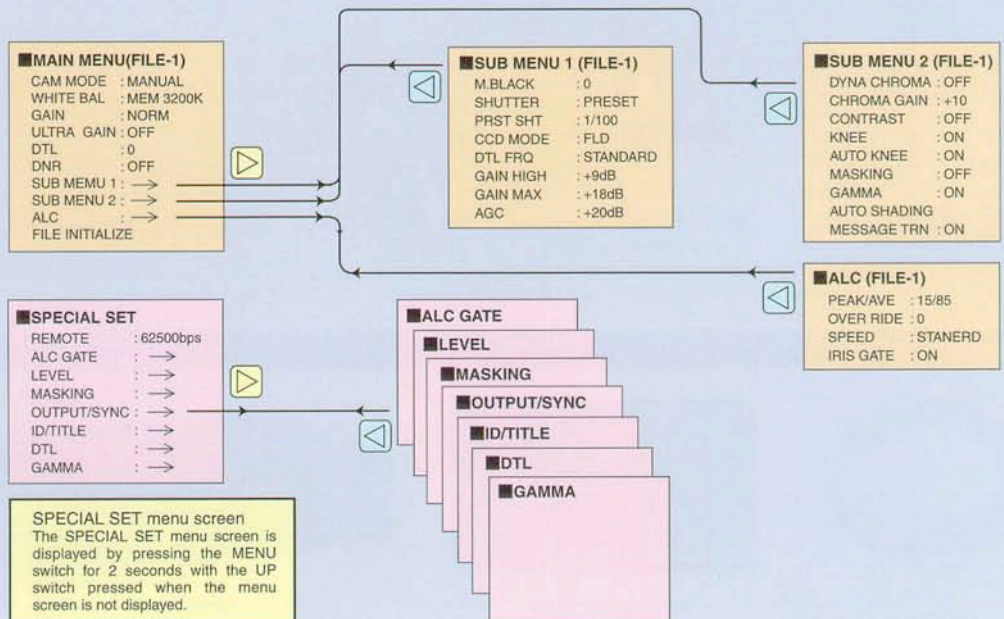

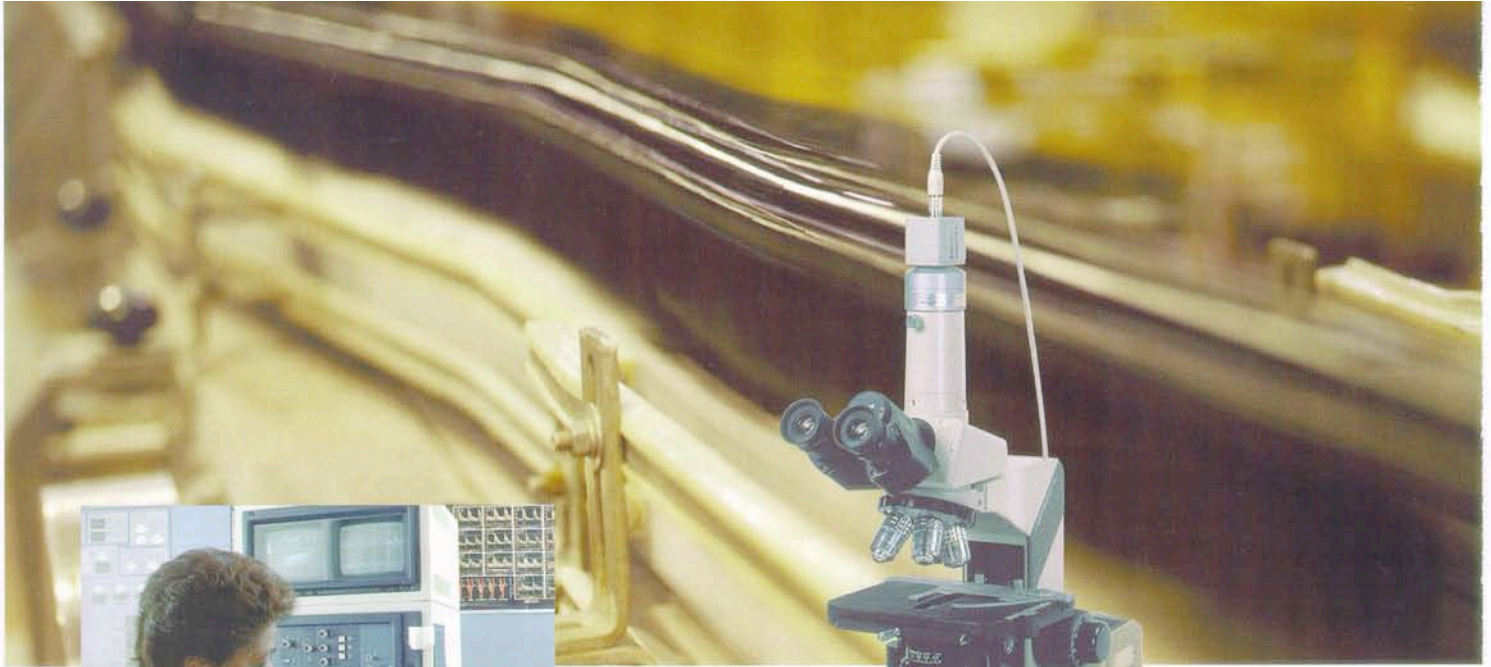

System configuration

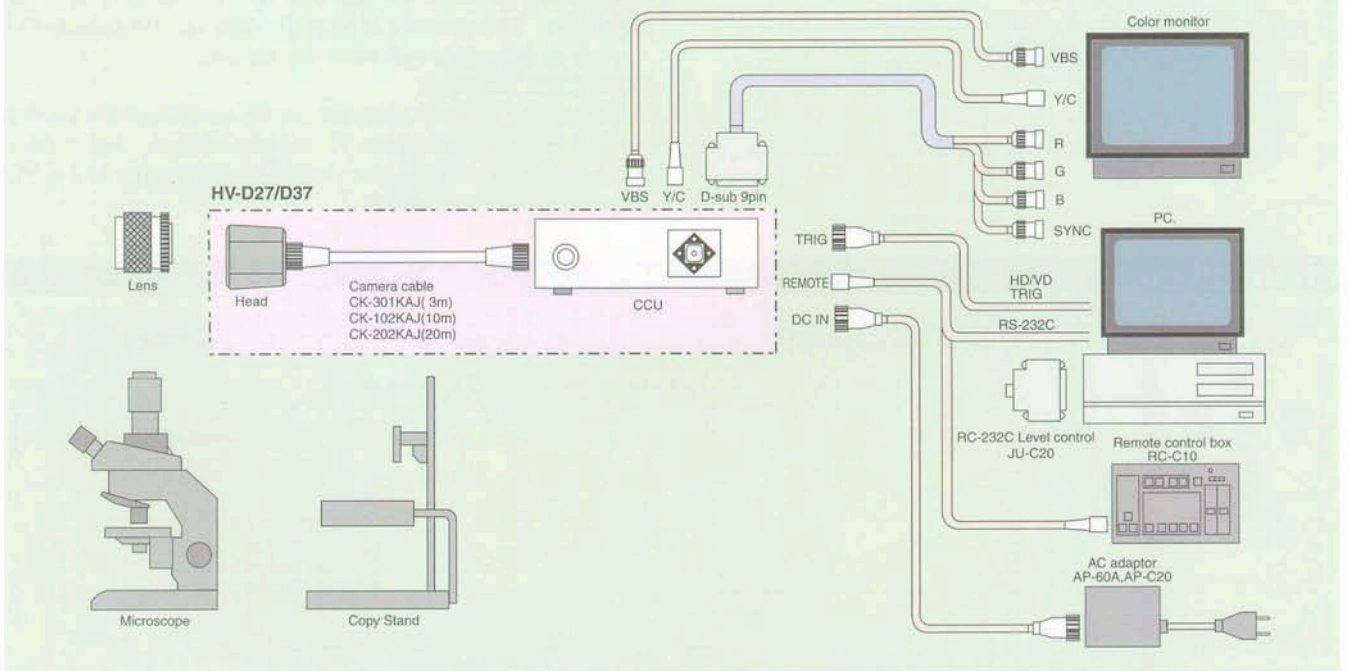

Accessories



Cable



Remote control box
RC-C10



Junction box
JU-Z2



Level converter
JU-C20

Specifications

Color system	NTSC, PAL
Optical system	HV-D27:1/2-inch f1.6 prism HV-D37:1/3-inch f2.2 prism
Imaging device	HV-D27:1/2-inch interline CCD (with microlenses) HV-D37:1/3-inch interline CCD (with microlenses)
Effective pixels	NTSC:768(H)×494(V) PAL:752(H)×582(V)
Effective image area	HV-D27:NTSC:6.45(H)×4.84(V)mm PAL:6.47(H)×4.83(V)mm HV-D37:NTSC:4.88(H)×3.66(V)mm PAL:4.89(H)×3.64(V)mm
Encoder system	R-Y/B-Y
Sync system	Internal / external (VBS, BBS or HD/VD)
Horizontal resolution	HV-D27:800 TV lines HV-D37:750 TV lines (Y signal center, Y OUT and DTL off)
Signal to noise ratio	HV-D27:62dB(NTSC), 60dB(PAL) HV-D37:60dB(NTSC), 58dB(PAL) (DNR:ON, Y OUT, $\gamma=1$, DTL off, Gain 0 dB)
Standard sensitivity	2000 lux, f8.0
Minimum illumination	HV-D27:1.5lux (50 IRE, F1.6, GAIN +20 dB, ULTRA GAIN:ON) HV-D37:2.8lux (50 IRE, F2.2, GAIN +20 dB, ULTRA GAIN:ON)
Gamma correction	0.35 to 1.0 (on/off selectable)
Picture distortion	Total:0% (not including lens characteristics)
Registration	Total:0.05% (not including lens characteristics)
Vertical contour correction	2H
Lens mount	C-mount (flangeback:17.526mm in air)
Sensitivity selection	AGC (0 to +20 dB), Norm/High/Max, Ultra gain
Scene files	3 scene files
CCD drive functions	
Preset	1/100 (1/60 PAL), 1/250, 1/500, 1/1,000, 1/2,000, 1/4,000, 1/10,000 second
Lockscan	NTSC:1/60.38 to 1/251.5 second (1H steps) PAL:1/50.31 to 1/253.8 second (1H steps)
AES	Off to approx. 1/50,000 second
Long integration (Selectable field/frame integration)	NTSC:1/30 to approx. 8 seconds (1frame steps) PAL:1/25 to approx. 8 seconds (1frame steps) (External picture memory required for continuous picture.)
Color bar	NTSC:SMPTE, PAL:FULL
Power supply voltage	12V rated (Stable operation at 10.5 to 17V DC)
Power consumption	10.5 W Approx.
Dimensions	HEAD:38.5(W)×46(H)×41.5(D)mm CCU:150(W)×45(H)×170(D)mm
Mass	HEAD: 90g Approx. (excluding lens and cable) CCU: 930g Approx.
Ambient temperature (operating)	0 to 45°C
Ambient temperature (storage)	-20 to 60°C

Input and output signals

Input signal conditions	
Genlock input	VBS 1.0 Vp-p / ± 3 dB or black burst / 75 Ω HD /VD TTL level (AUX connector)
Serial data (4 pin connector) *1	1.5 Vp-p / high RS-232C level
Output signal ratings	
Composite video (BNC, D-sub connector)	VBS 1.0 Vp-p / 75 Ω
Y / C (D-sub, Y / C connectors)	Y : 1.0 Vp-p / 75 Ω C : NTSC 0.28 Vp-p (burst) / 75 Ω PAL 0.3 Vp-p (burst) / 75 Ω
Component (D-sub connector)	Y : 1.0 Vp-p / 75 Ω R-Y : 0.7 Vp-p / 75 Ω B-Y : 0.7 Vp-p / 75 Ω
RGB (D-sub connector)	R : 0.7 Vp-p / 75 Ω G : 0.7 Vp-p / 75 Ω B : 0.7 Vp-p / 75 Ω
Sync (D-sub connector)	HD : 2 Vp-p / 75 Ω VD : 2 Vp-p / 75 Ω SYNC : 2 Vp-p / 75 Ω
Serial data (4 pin connector) *1	1.5 Vp-p / Low (RC-10 connected) RS-232C level (personal computer connected)

*1: Set internal switch according to connected equipment.

Standard composition

Camera head, CCU (HV-D27/D37)	1
Supplied accessories	
Power supply plug (RM12BPG-3S)	1
Operation manual	1

Dimensions

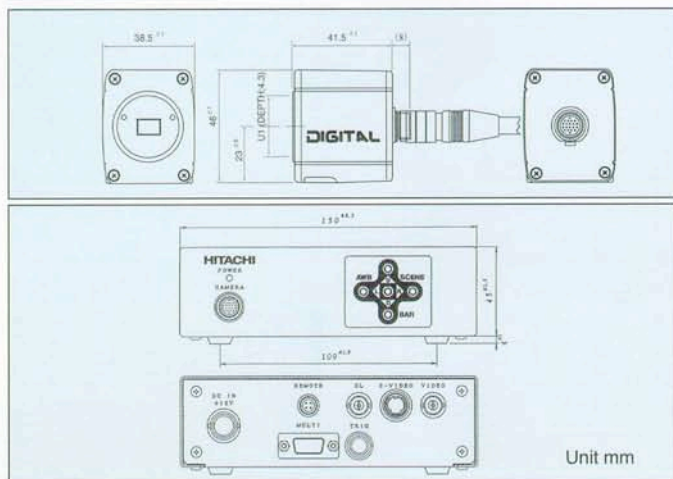

CAUTION : To product ensure safe operation, please read the instruction manual before using this product.

Hitachi Kokusai Electric Inc.

Head Office 14-20, Higashi-Nakano 3-chrome, Nakano-ku, Tokyo 164-8511, Japan
Phone : +81 (0) 3-3365-5928, Fax : +81 (0) 3-3365 5929
URL : www.h-kokusai.com

Hitachi Denshi (Europa) GmbH

Head office Weiskircher Straße 88, D-63110 Rodgau, Germany
Phone : +49 6106-69920, Fax : +49 6106-16906
URL : www.hitachi-denshi.de
General email address : webmaster@hitachi-denshi.de

Hitachi Denshi (Europe)

Leeds Office Brookfield House, Selby Road, Garforth, LEEDS, LS25 1NB, United Kingdom
Phone : +44 (0)113 287 4400, Fax : +44 (0)113 287 4260
URL : www.hitachi-denshi-uk.com
General email address : sales@hitachi-denshi-uk.com

Hitachi Denshi (UK) Limited

Head office Windsor House, Britannia Road, Waltham Cross, Hertfordshire, EN8 7NX, United Kingdom
Phone : +44 (0) 1992 704 595, Fax : +44 (0) 1992 704 599

Specification are subject to change without notice.