

# FOR A GOOD **REASON** **GRUNDIG**

Owner's Manual

en

IP Cameras & Domes

---

GCI-H0503B	720P HD IP Col/B&W Camera WDR Low Light
GCI-H0602B	720P HD IP Colour Camera
GCI-K0503B	1080P Full HD IP Col/B&W Camera

---

GCI-K0503B. 11.1.28.01.2011  
© ASP AG



Design and specifications are subject to change without notice



---

**Content:**

<b>1. Introduction</b>	1	18. Factory Default	50
<b>2. Important Safety Instructions</b>	2	19. Software Version	51
<b>3. Package Contents</b>	2	20. Software Upgrade	52
<b>4. Installation</b>	3	21. Maintenance	53
1. Camera Overview		<b>10. Streaming Settings</b>	54
2. System Requirements		1. Video Format	54
3. Lens Mounting	4	2. Video Compression	57
4. Power Connection	4	3. Video OCX Protocol	59
5. Ethernet Cable Connection	(	4. Video Frame Skip	59
6. Alarm Application	5	5. Video Mask	61
<b>5. Deleting the Existing GRUNDIG Viewer</b>	5	6. Audio Mode and Bit Rate Settings	62
<b>6. Accessing the Camera</b>	7	<b>11. Camera Settings</b>	63
<b>7. Browser-based Viewer Introduction</b>	12	1. Exposure Setting	63
<b>8. Home Page</b>	13	2. White Balance Setting	64
<b>9. System Related Settings</b>	14	3. Backlight Setting	64
1. Host Name and System Time Setting	15	4. Brightness Setting	65
2. Security	15	5. Sharpness Setting	65
3. Network	24	6. Contrast Setting	65
4. DDNS	30	7. Saturation Setting	65
5. Mail	31	8. Hue Setting	65
6. FTP	32	9. Digital Zoom Setting	65
7. HTTP	33	10. IR Function	65
8. Application (Alarm Settings)	33	11. WDR Function	66
9. Motion Detection	38	12. 3DNR Function	66
10. Tampering	(%	13. TV System Setup	66
11. Storage Management	42	<b>12. Logout</b>	66
12. Recording	45	<b>13. CMS Software Introduction</b>	67
13. File Location	47	<b>14. Internet Security Settings</b>	67
14. Iris Adjustment	47	<b>15. GRUNDIG Viewer Download Procedure</b>	70
15. View Log File	47	<b>16. Install UPnP Components</b>	72
16. View User Information	49	<b>17. Back Focus Adjustment</b>	75
17. View Parameters	50		

---

**1. Introduction**

Following the high standards of GRUNDIG IP Cameras, this IP Camera is capable of serving real-time streaming and makes the images run smoothly. It offers a very economical solution to serve a 2 Megapixel resolution.

In addition to MJPEG real time streaming, this IP Camera develops a superior H.264 main profile codec to smoothly transfer High Definition surveillance data through the Internet without distortion. Attributing to the IP Camera's flexible platform, the camera can be applied in various installation locations including shops, stores, banks, parking lots, factories and building surveillance.

The built-in Wide Dynamic Range (WDR) function of the model GCI-H0503B allows getting crystal clear images even in extreme conditions. This IP Camera is highly sensitive and has a good low-light performance.

These instructions apply to the following products. For the different properties of the products please refer to the table. Please note that not all chapters and screenshots in this manual refer to every camera of this series.

Model	Sensor	HD	WDR	3DNR
GCI-H0503B	CCD	720p	✓	✓
GCI-H0602B	CMOS	720p	-	-
GCI-K0503B	CMOS	1080p	-	-

## 2. Important Safety Instructions

Be sure to use only the standard adapter that is specified in the specification sheet. Using any other adapter could cause fire, electrical shock, or damage to the product. Incorrectly connecting the power supply or replacing battery may cause explosion, fire, electric shock, or damage to the product. Do not connect multiple cameras to a single adapter. Exceeding the capacity may cause abnormal heat generation or fire.

Do not place conductive objects (e.g. screwdrivers, coins or any metal items) or containers filled with water on top of the camera. Doing so may cause personal injury due to fire, electric shock, or falling objects.

If any unusual smells or smoke come from the unit, stop using the product. In such case, immediately disconnect the power source and contact the service center. Continued use in such a condition may cause fire or electric shock.

If this product fails to operate normally, contact the nearest service center. Never disassemble or modify this product in any way. (GRUNDIG is not liable for problems caused by unauthorized modifications or attempted repair.)

To prevent fire or electric shock, do not expose the inside of this device to rain or moisture.

## 3. Package Contents

These parts are included:

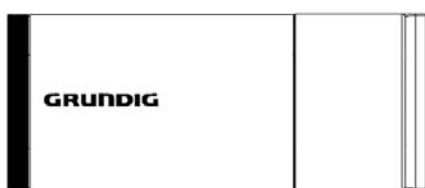

Camera



CD

(bundled software and documentation)



Power Terminal Block  
(not included for GCI-0602B)



Back Focus Adjuster



Quick Guide

## 4. Installation

Do not install in a location subject to high temperature (over 50°C), low temperature (below -10°C), or high humidity. Doing so may cause fire or electric shock. Keep out of direct sunlight and heat radiation sources. It may cause fire. Avoid aiming the camera directly towards extremely bright objects such as sun, as this may damage the image sensor.

Do not install the unit in humid, dusty, or sooty locations. Doing so may cause fire or electric shock. Install it in a place with good ventilation.

When installing the camera, fasten it securely and firmly. A falling camera may cause personal injury.

If you want to relocate the already installed product, be sure to turn off the power and then move or reinstall it.

### 4.1. Camera Overview

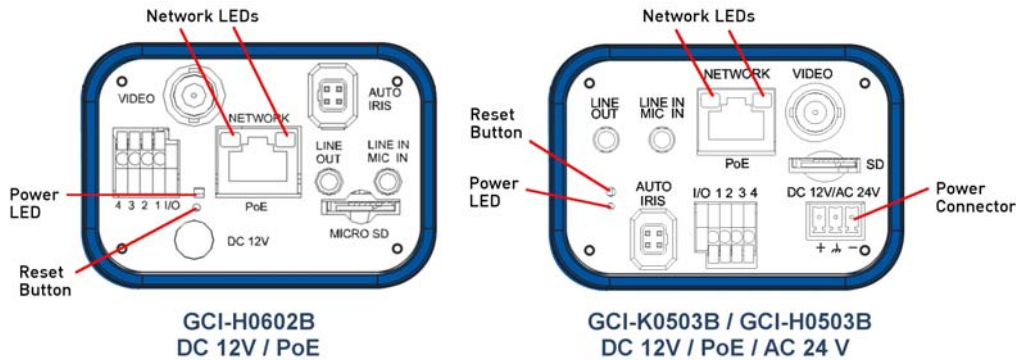

1. LINE OUT & LINE IN / MIC IN: Two-way audio transmission
2. Power LED: Green light indicates good power connection.
3. Reset button: Press and hold the button for 5 seconds, and then the camera will reset to factory defaults. After around 30 seconds, reconnect the camera by entering its default IP address: 192.168.1.1, in the URL bar.
4. AUTO IRIS connector: Auto iris lens connector
5. NETWORK (with PoE) Connector: RJ45 connector for LAN connection
6. Network LEDs: Green Link Light indicates good network connection. Orange Activity Light flashes for network activity indication.
7. I/O Terminal Connector: For alarm connection
8. VIDEO (BNC connector): For video output
9. Micro SD Card slot: For video and snapshots storage
10. For GCI-H0602B: 12V connector / For GCI-K0503B and GCI-H0503B: AC 24V/DC 12V Connector (Please refer to the table below for wiring the AC 24V/DC 12V camera with the supplied power cable).

	+	AC 24V: Power-1	DC 12V: Power
	⏚	AC 24V: Earth GND	DC 12V: Reserved
	-	AC 24V: Power-2	DC 12V: GND

### 4.2. System Requirements

To perform the IP Camera via web browser, please ensure your PC is in good network connection, and meets the system requirements as described below.

Personal Computer :

- 1.) Intel Pentium M, 2.16 GHz or Intel Core 2 Duo, 2.0 GHz
- 2.) 2 GB RAM or more

Operating System :

Windows XP / Windows VISTA / Windows 7

---

Web Browser :

Microsoft Internet Explorer 6.0 or later

Firefox

Chrome

Safari

Network Card :

10Base-T (10 Mbps) or 100Base-TX (100 Mbps) operation

Viewer :

ActiveX control plug-in for Microsoft IE

### 4.3. Lens Mounting

Lens Mounting: C/CS Mount Lens Model:

If using a C-Mount lens, after removing the camera's plastic cover, users need to mount the C/CS mount adapter to the camera. Then attach the lens onto the C/CS mount adapter, as the illustrations show below.



**C/CS Mount Adapter (on camera)**



**Completion**

### 4.4. Power Connection

Power connection for GCI-H0602B:

To power up the IP Camera, please plug the camera's DC 12V cable into the power outlet. Alternatively, connect the Ethernet cable to the camera's PoE port and plug the other end of the cable into a PoE switch.

NOTE: If using PoE, make sure the Power Sourcing Equipment (PSE) is in use in the network.

Power Connection for GCI-K0503B and GCI-H0503B:

Please refer to section 4.1. Camera Overview for power wiring. Additionally, if using PoE, make sure Power Sourcing Equipment (PSE) is in use in the network.

### 4.5. Ethernet Cable Connection

Use of Category 5 Ethernet cable is recommended for network connection; to have best transmission quality, cable length shall not exceed 100 meters. Connect one end of the Ethernet cable to the RJ45 connector of the IP Camera, and the other end of the cable to the network switch or PC.

NOTE: In some cases, you may need use an Ethernet crossover cable when connecting the IP Camera directly to the PC.

Check the status of the link indicator and activity indicator LEDs; if the LEDs are unlit, please check LAN connection.

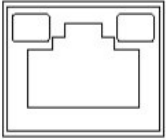

Green Link Light indicates good network connection.  
Orange Activity Light flashes for network activity indication.

#### 4.6. Alarm Application

The camera equips one alarm input and one relay output for alarm application. Refer to alarm pin definition below to connect alarm devices to the IP Camera if needed.

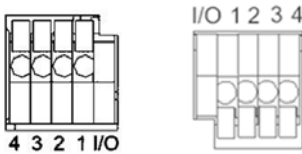

PIN 1: Output+  
PIN 2: Output-  
PIN 3: Input+  
PIN 4: Input-

#### 5. Deleting the Existing GRUNDIG Viewer

For users who have installed the GRUNDIG Viewer for 1.3 Megapixel Series IP Cameras on the PC, please first delete the existing DC Viewer from the PC before accessing this IP Camera.

Deleting the GRUNDIG Viewer :

Click "Control Panel", and then click on "Add or Remove Programs". In the "Currently installed programs" list, select "GRUNDIG Viewer" and click the button "Remove" to uninstall the existing GRUNDIG Viewer as shown in the figure below.

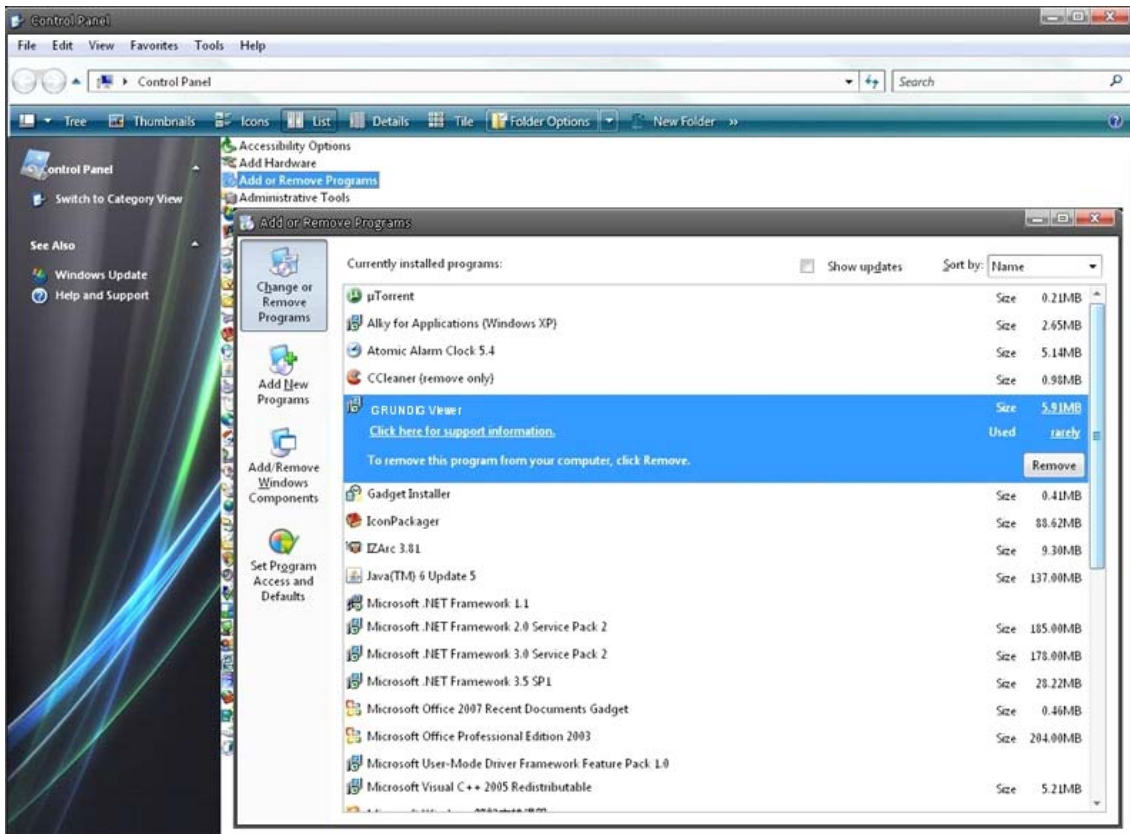

---

## Deleting Temporary Internet Files :

To improve the browser performance, it is suggested to clean up all the files in the Temporary Internet Files. The procedure is as follows (for other web browsers please read the corresponding manuals):

STEP 1: Click on the “Tools” tab and select the option “Internet Options”.

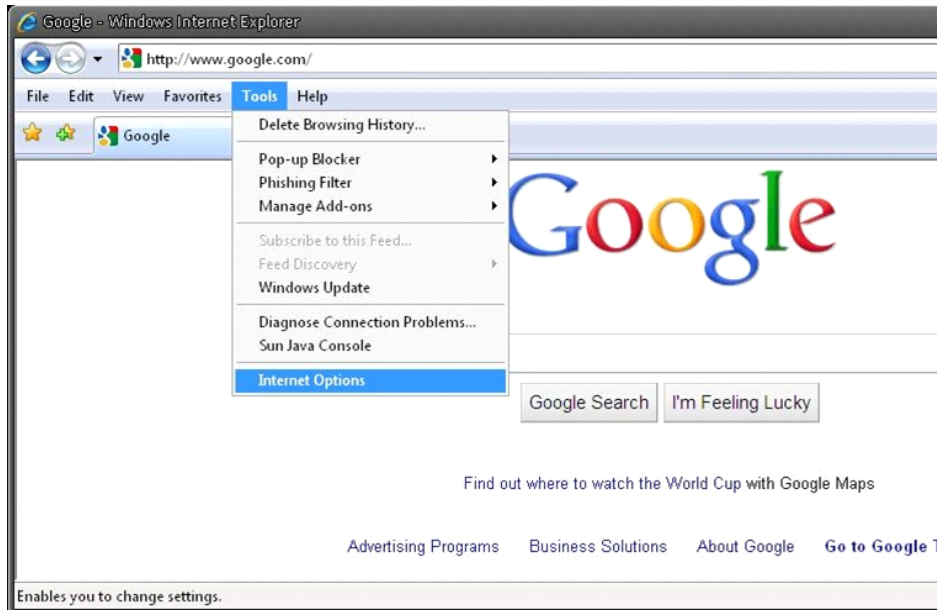

STEP 2: Click on “Delete”, then tap the “Delete Files” in the “Temporary Internet files” section.

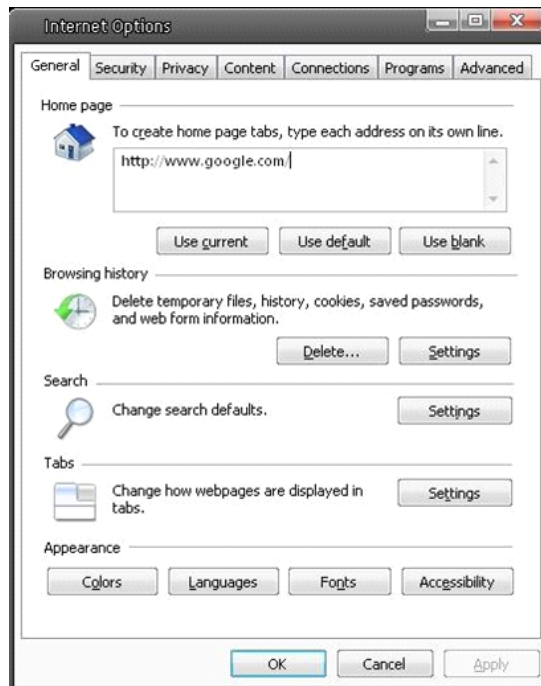





## 6. Accessing the Camera

For initial access to the IP Camera, users can search the camera through the installer program: GRUNDIG Finder.exe, which can be found on the supplied CD.

GRUNDIG Finder Software Setup :

Step 1: Double-click on the program GRUNDIG Finder.exe (see the icon below); its window will appear as shown below. Then click the "Find Device" button.

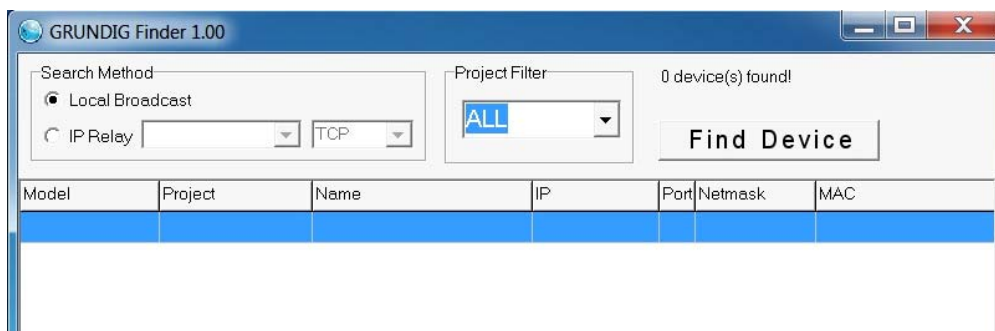

Step 2: The security alert window will pop up. Click "Unblock" to continue.



Device Search :

Step 3: Click "Find Device" again, and all the IP devices found will be listed on the page, as shown in the picture below. The IP Camera's default IP address is: 192.168.1.1.

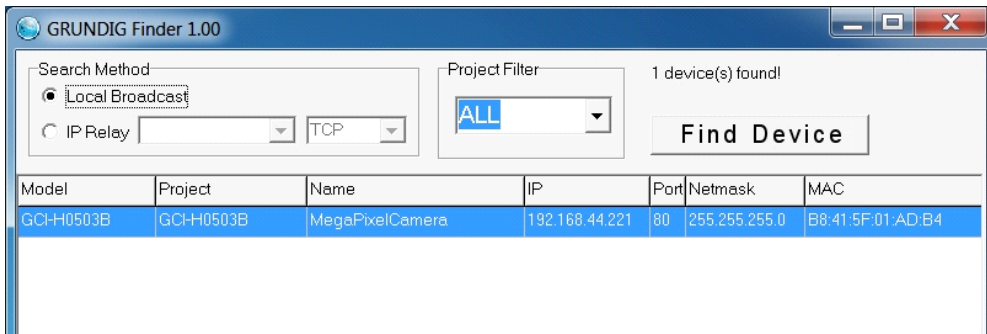

Step 4: Double-click or right-click and select "Browse" to access the camera directly via web browser.

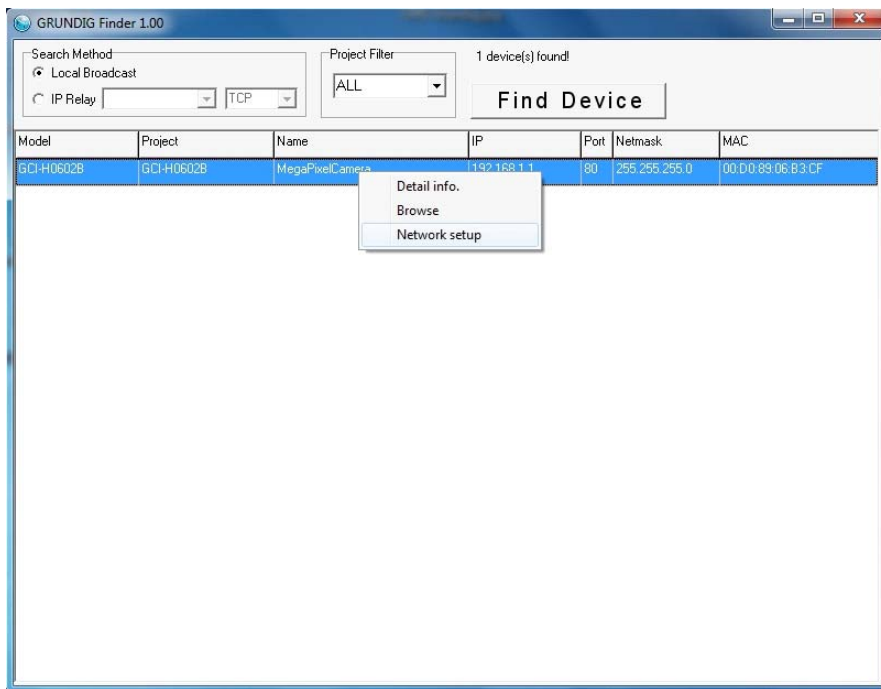

Step 5: Then the dialogue box for entering the default username and password (as shown below) will appear for logging in to the IP Dome Camera.



The default login ID and password for the Administrator are:

Login ID: admin  
Password: 1234

NOTE: ID and password are case sensitive.

It is strongly advised that administrator's password be altered for security concerns. Refer to section 9.2. Security for further details.

Additionally, users can change the IP Camera's network property, either DHCP or Static IP, directly in the device finding list. Refer to the following section for changing the IP Camera's network property.

Example of changing IP Camera's network property :

Users can directly change an IP Camera's network property, e.g. from static IP to DHCP, in the finding device list. The way to change the IP Camera's network property is specified below:

Step 1: In the finding device list, click on the IP Camera of which you would like to change the network property. On the selected item, right-click and select "Network Setup". Meanwhile, record the IP Camera's MAC address, for future identification.

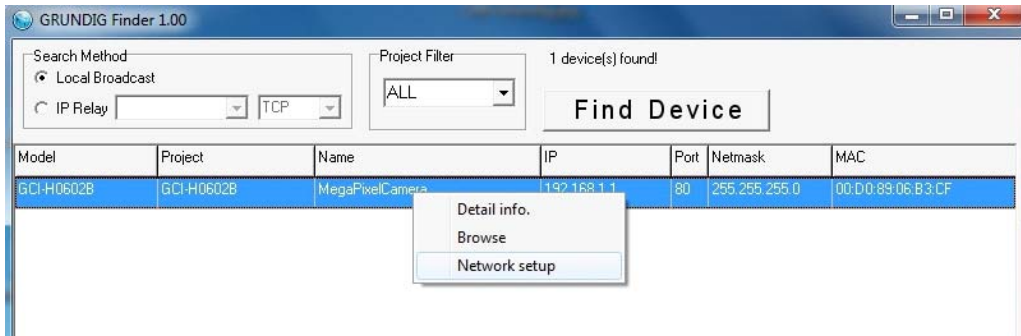

Step 2: The "Network Setup" page will come out. Select "DHCP," and press the "Apply" button down the page.

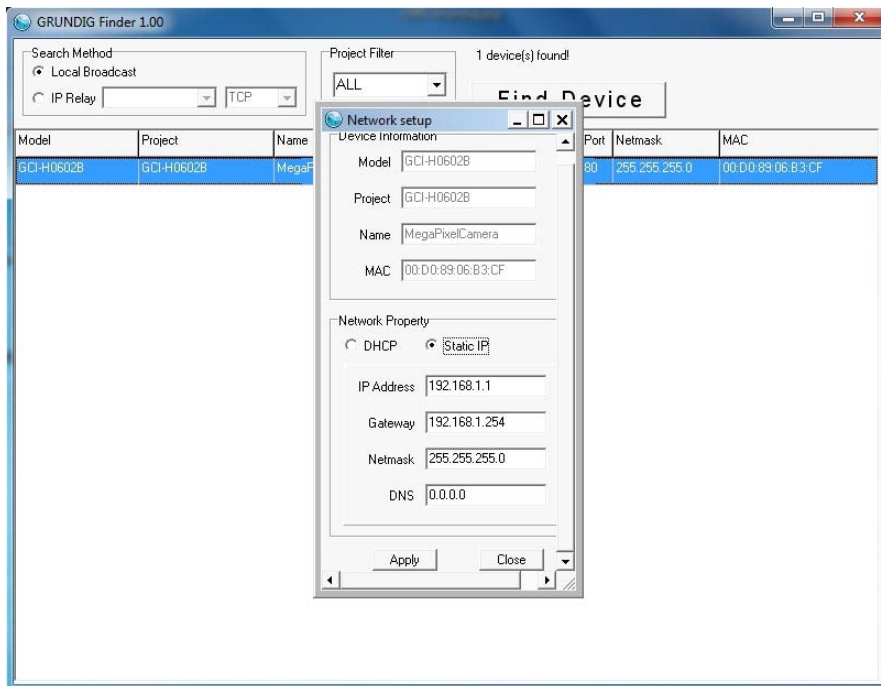

Step 3: Click "OK" on the Note of setting change. Wait for one minute to re-search the IP Camera.

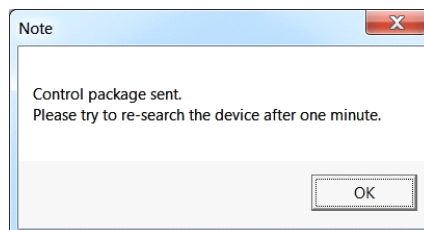

Step 4: Click the “Find Device” button to search all the devices. Then select the IP Camera with the correct MAC address. Double-click on the IP Camera, and the login window will come out.

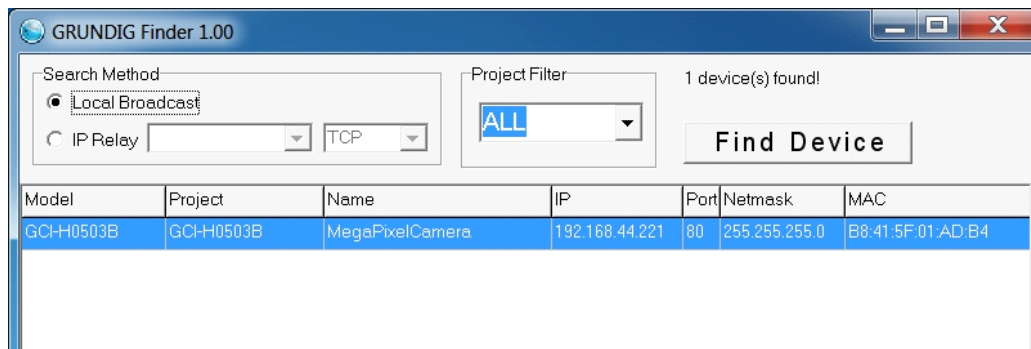

Step 5: Enter User name and Password to access the IP Camera.

Installing the GRUNDIG Viewer Software Online :

For initial access to the IP Camera, a client program, DC Viewer, will be automatically installed to your PC when connected to the IP Camera.

If the Web browser doesn't allow the GRUNDIG Viewer installation, please check the Internet security settings or ActiveX controls and plug-ins settings (see 14. Internet Security Settings) to continue the process.

The Information Bar (just below the URL bar) may come out and ask for permission to install the ActiveX Control for displaying video in browser (see the picture below). Right-click on the Information Bar and select “Install ActiveX Control...” to allow the installation.

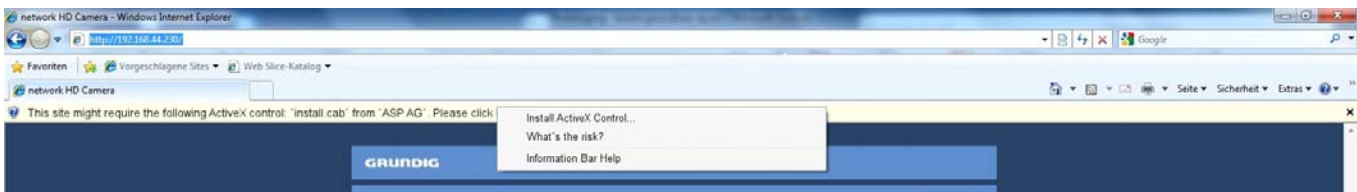

Then the security warning window will pop up. Click “Install” to carry on software installation.

Click “Finish” to close the GRUNDIG Viewer window when download is finished. For the detailed software download procedure, please refer to chapter 10. DC Viewer Download Procedure.

Once logged in to the IP Camera, users will see the Home page as shown below:

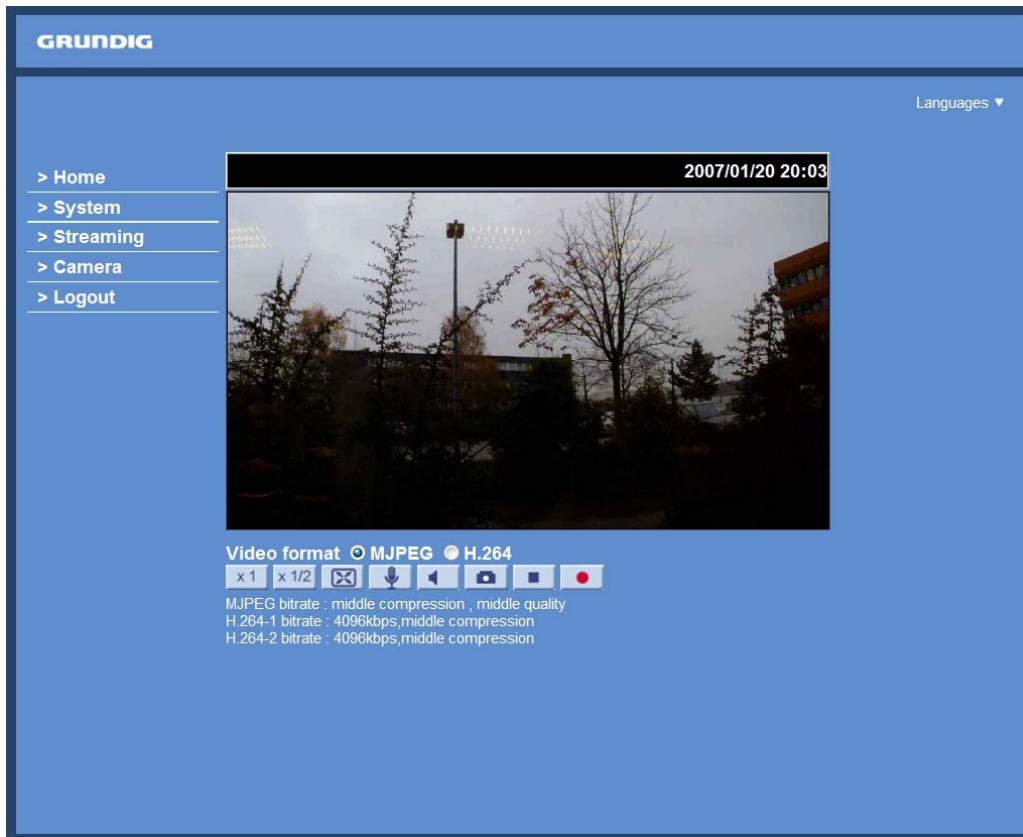

#### Administrator/User Privileges :

“Administrator” represents the person who can configure the IP Camera and who authorizes users to have access to the camera; “User” refers to whoever has access to the camera with limited authority, i.e. to enter Home and Camera setting pages.

#### Image and Focus Adjustment :

This image appears on the Home page when successfully accessing to the IP Camera. Adjust zoom and focus as necessary to produce a clear image.

---

## 7. Browser-based Viewer Introduction

The picture below shows the Home page of the IP Camera's viewer window.

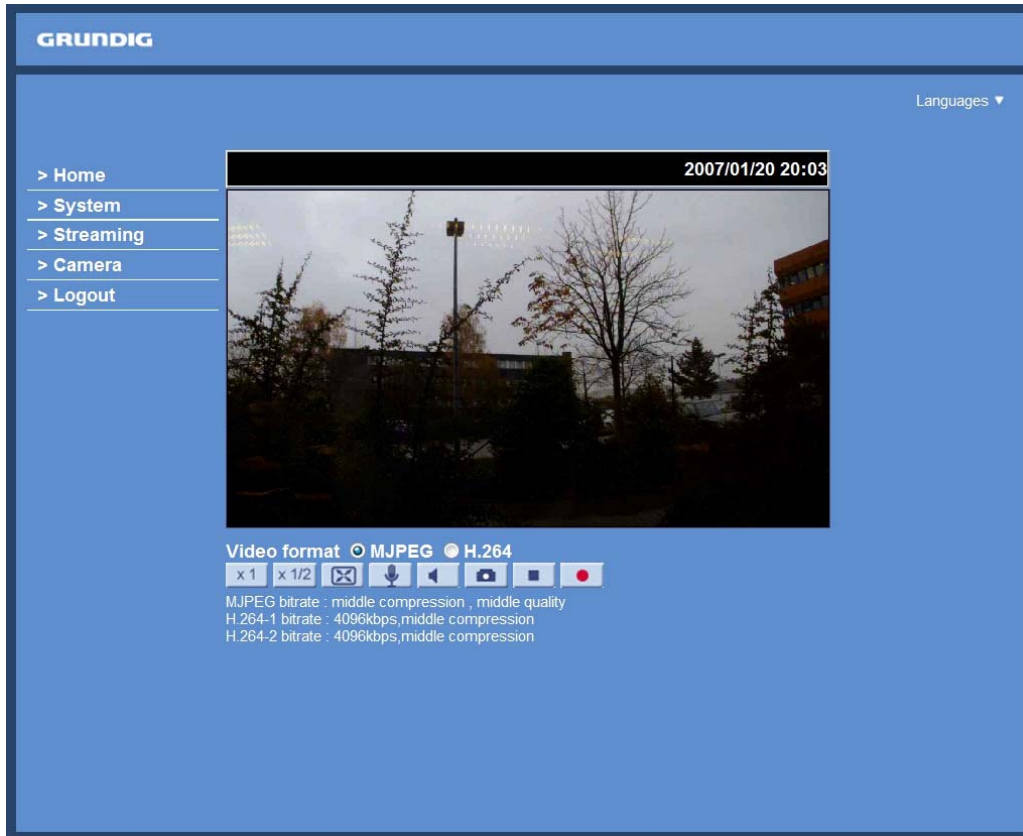

There are five tabs: Home, System, Streaming, Camera and Logout (on the left hand side).

Home :

Users can monitor the live video of the targeted area.

System setting :

The administrator can set host name, system time, admin password, network related settings, etc. Further details will be interpreted in chapter 9. System Related Settings.

Camera setting :

Users can adjust various camera parameters.

Logout :

Click on the tab to re-login the IP Camera with another username and password.

## 8. Home Page

In the Home page, there are several function buttons right down the displayed image.

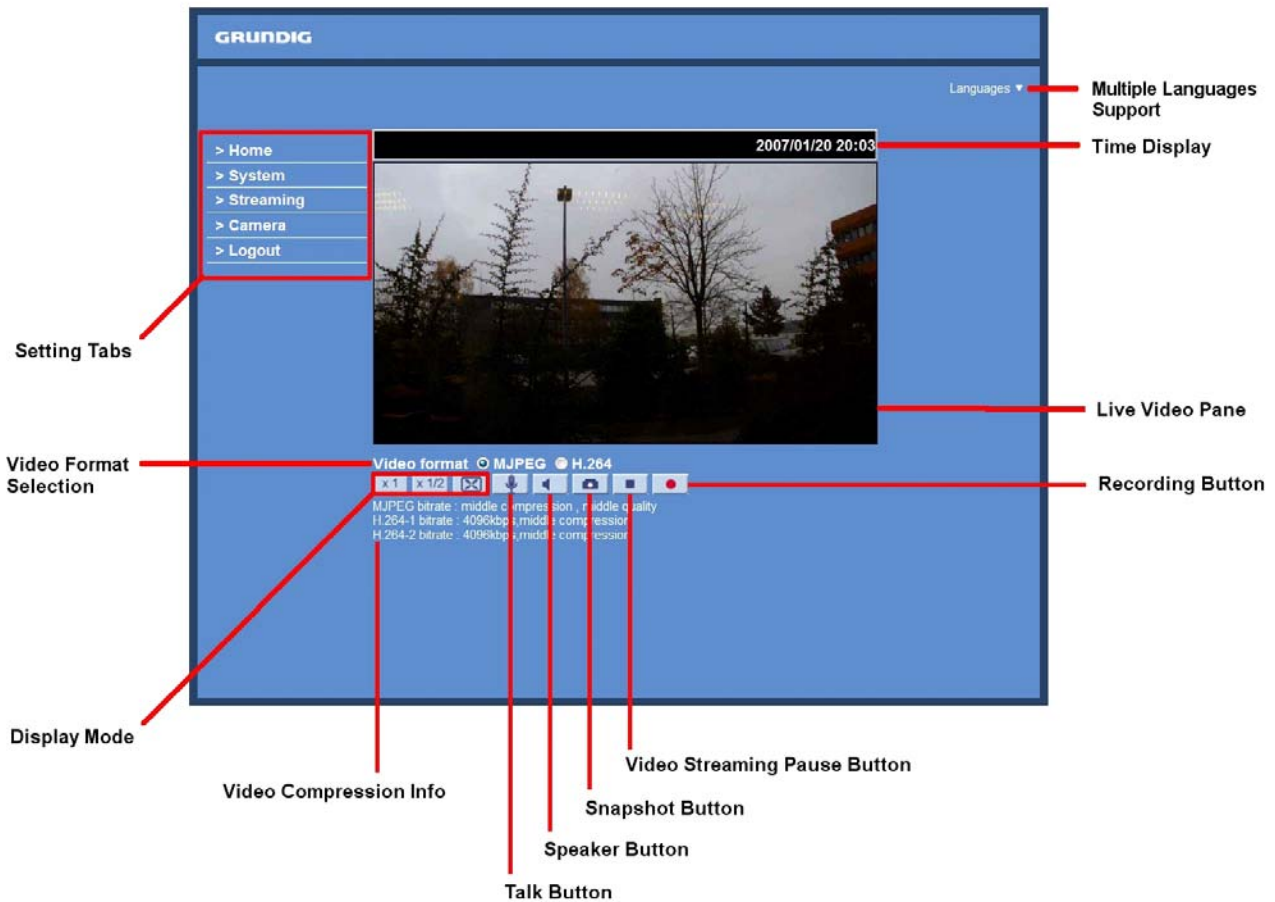

NOTE: Please note that the function buttons will vary depending on the camera model.

Display Mode (Screen Size Adjustment) :  
Image display size can be adjusted to x1/2 and full screen.

Digital Zoom Control :  
In the full screen mode, users can implement digital PTZ by rotating the mouse wheel (for zoom in/out), and drag the mouse into any direction.

Talk button (on/off) :  
Talk function allows the local site to talk to the remote site. Click on the button to switch it to on/off. Please refer to section 9.2. Security: User >> Add user >> Talk/Listen for further details. This function is only open to the "User" who has been granted this privilege by the Administrator.  
Please note that additional equipment will be necessary.

Speaker button (on/off) :  
Press the Speaker button to mute/activate the audio.

Snapshot button :  
Press the button, and the JPEG snapshots will automatically be saved in the appointed place. The default place of saving snapshots is: C:\. For changing the storage location, please refer to section 9.13. File Location for further details.

NOTE: Users with Windows 7 operating system need to follow the following procedure to be able to use the Snapshot function. First you need to log on to your computer as an Administrator. Then you go to Windows Start menu, click with the right mouse button on your Internet Browser and select in the appearing pop-up window "Run as Administrator". Afterwards you can log in to your camera as usual (as an administrator or user).



## 9. System Related Settings

The picture below shows all categories under the “System” tab. Each category in the left column will be explained in the following sections.

NOTE: The “System” configuration page is only accessible by the Administrator.

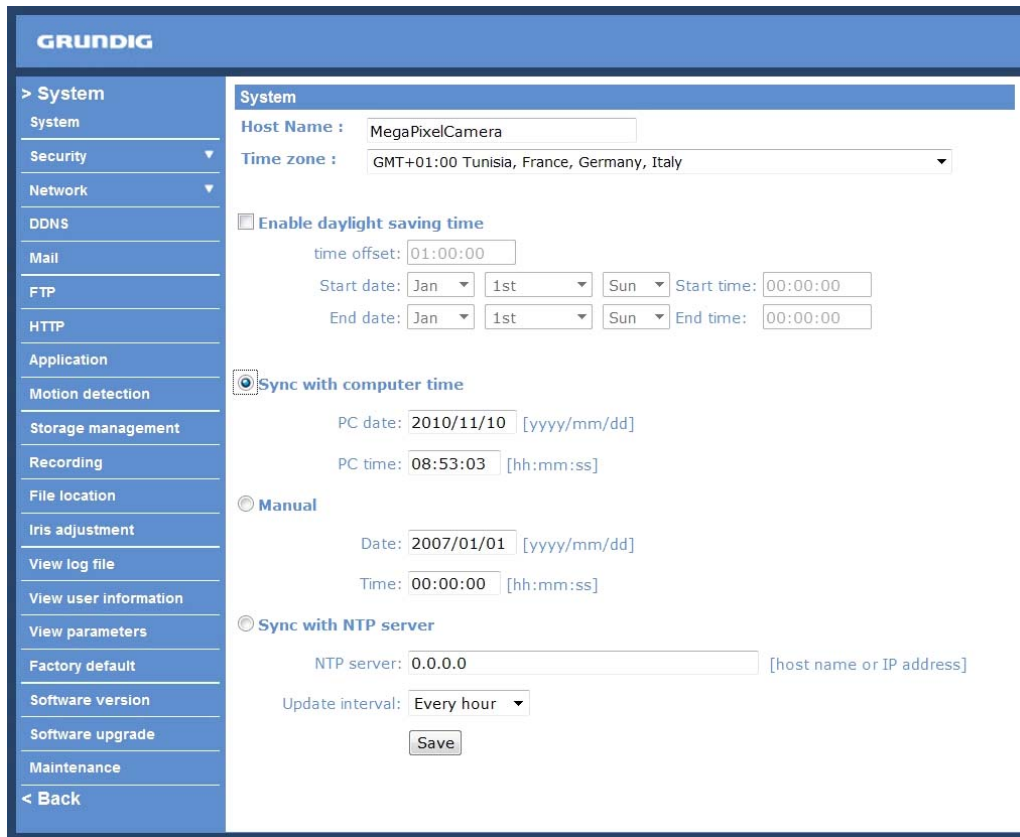

The screenshot displays the Grundig System configuration interface. On the left is a navigation menu with categories: System, Security, Network, DDNS, Mail, FTP, HTTP, Application, Motion detection, Storage management, Recording, File location, Iris adjustment, View log file, View user information, View parameters, Factory default, Software version, Software upgrade, Maintenance, and Back. The main content area is titled 'System' and contains the following settings:

- Host Name :** MegaPixelCamera
- Time zone :** GMT+01:00 Tunisia, France, Germany, Italy
- Enable daylight saving time**
  - time offset: 01:00:00
  - Start date: Jan 1st Sun Start time: 00:00:00
  - End date: Jan 1st Sun End time: 00:00:00
- Sync with computer time**
  - PC date: 2010/11/10 [yyyy/mm/dd]
  - PC time: 08:53:03 [hh:mm:ss]
- Manual**
  - Date: 2007/01/01 [yyyy/mm/dd]
  - Time: 00:00:00 [hh:mm:ss]
- Sync with NTP server**
  - NTP server: 0.0.0.0 [host name or IP address]
  - Update interval: Every hour
  - Save

### 9.1. Host Name and System Time Setting

Press the first category: <System> in the left column; the page is shown below.

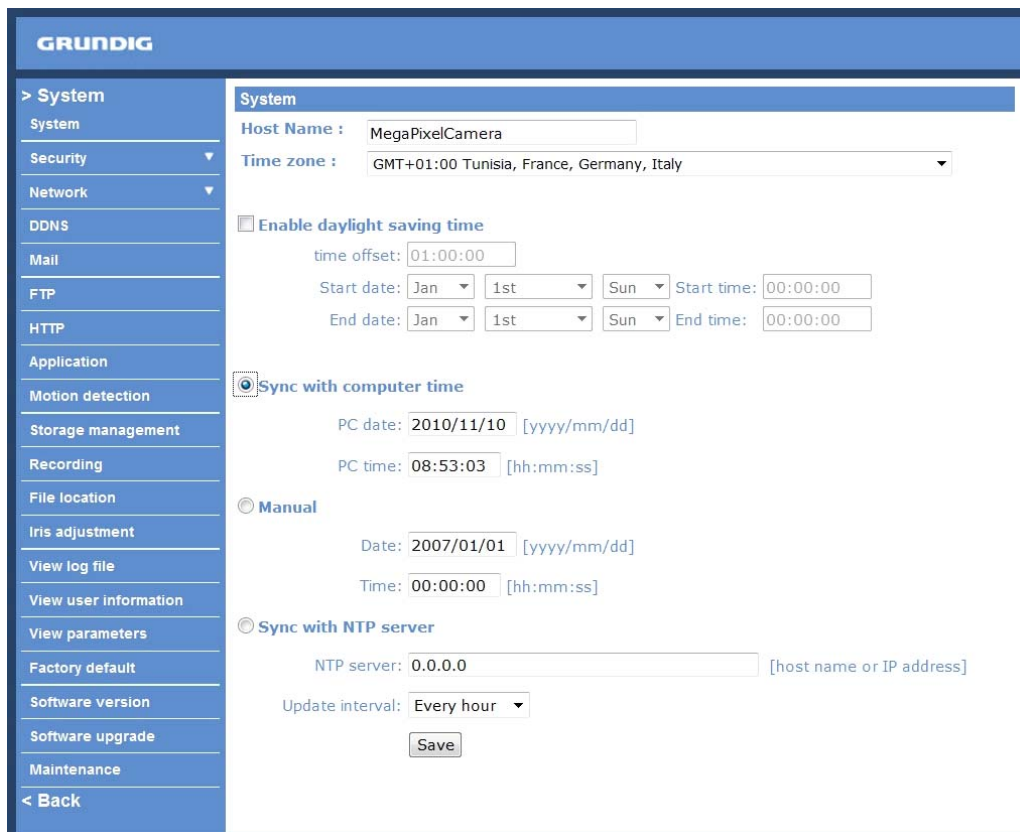

This screenshot is identical to the one above, showing the Grundig System configuration page with the same settings and navigation menu.



Host Name :

The name is for camera identification (max. 30 characters). If alarm function (see section 9.8. Application) is enabled and is set to send an alarm message by Mail/FTP, the host name entered here will display in the alarm message.

Time Zone :

Select the time zone you are in from the drop-down menu.

Sync with Computer Time :

Select the item, and video date and time display will synchronise with the PC's.

Manual :

The Administrator can set date, time and day manually. Entry format should be identical with that shown next to the enter fields.

Sync with NTP server :

Network Time Protocol (NTP) is an alternate way to synchronise your camera's clock with a NTP server. Please specify the server you wish to synchronise in the enter field. Then select an update interval from the drop-down menu. For further information about NTP, please see the web site: [www.ntp.org](http://www.ntp.org).

## 9.2. Security

Click the category: <Security>, there will be a drop-down menu with tabs including <User>, <HTTPS>, <IP Filter>, and <IEEE 802.1X>.

<User> :

Click the <User> tab under the category <Security> and the page is shown as the picture below.

NOTE: The following characters are valid: A-Z, a-z, 0-9, !#\$%&'-.@^\_~.

Admin Password :

Change the administrator's password by putting in the new password in both text boxes. The input characters/numbers will be displayed as dots for security purposes. After clicking <Save>, the web browser will ask the Administrator for the new password for access. The maximum length of the password is 14 digits.

---

#### Add User :

Type the new user's name and password and click <Add> to add the new user. The user name can have up to 16 characters, the password up to 14 characters. The new user will be displayed in the user name list. There is a maximum of twenty user accounts. To each user can be assigned the privileges of "Camera control", "Talk" and "Listen".

#### - I/O access:

This item supports fundamental functions that enable users to view video when accessing the camera.

#### - Camera control:

This item allows the specified User to change camera parameters on the Camera Setting page.

#### - Talk/Listen:

Talk and Listen functions allow the appointed user in the local site (PC site) communicating with, for instance, the administrator in the remote site.

#### Manage User :

To delete a user, pull down the user list, and select the user name you wish to delete. Then click <Delete> to remove it.

To edit a user, pull down the user list and select a user name. Click <Edit> to edit the user's password and privilege.

NOTE: It is required to enter the User password and to select the function open to the user. When finished, click <Save> to modify the account authority.

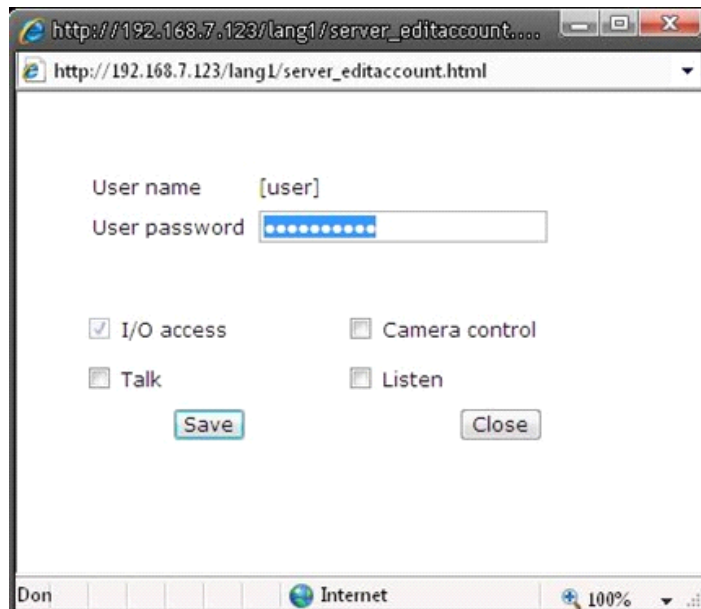

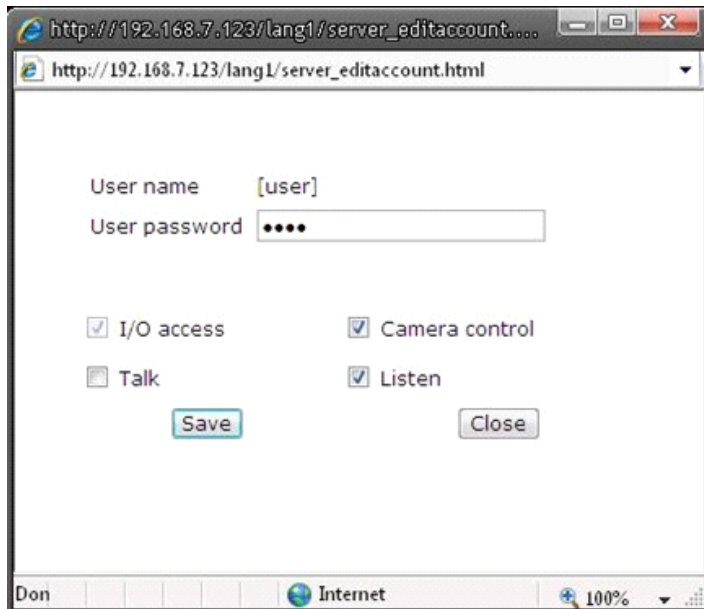

<HTTPS> :

<HTTPS> allows secure connections between the IP Camera and the web browser using the <Secure Socket Layer (SSL)> or the <Transport Layer Security (TLS)>, which prevent camera settings or Username/Password info from snooping. It is required to install a self-signed certificate or a CA-signed certificate for implementing <HTTPS>.

Click the <HTTPS> tab, and the HTTPS setting page is shown as the figure below.

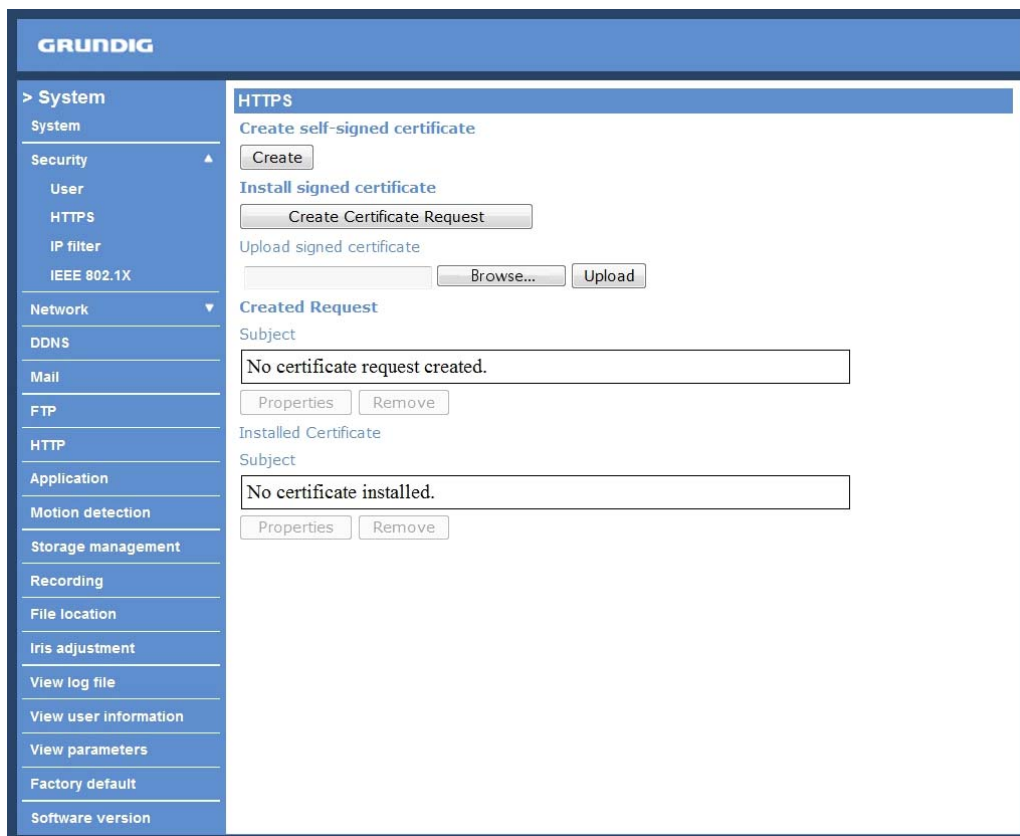

To use HTTPS on the IP Camera, a HTTPS certificate must be installed. The HTTPS certificate can be obtained by either creating and sending a certificate request to a Certificate Authority (CA) or creating a self-signed HTTPS certificate, as described below.

## Create Self-signed Certificate :

Before a CA-issued certificate is obtained, users can create and install a self-signed certificate first.

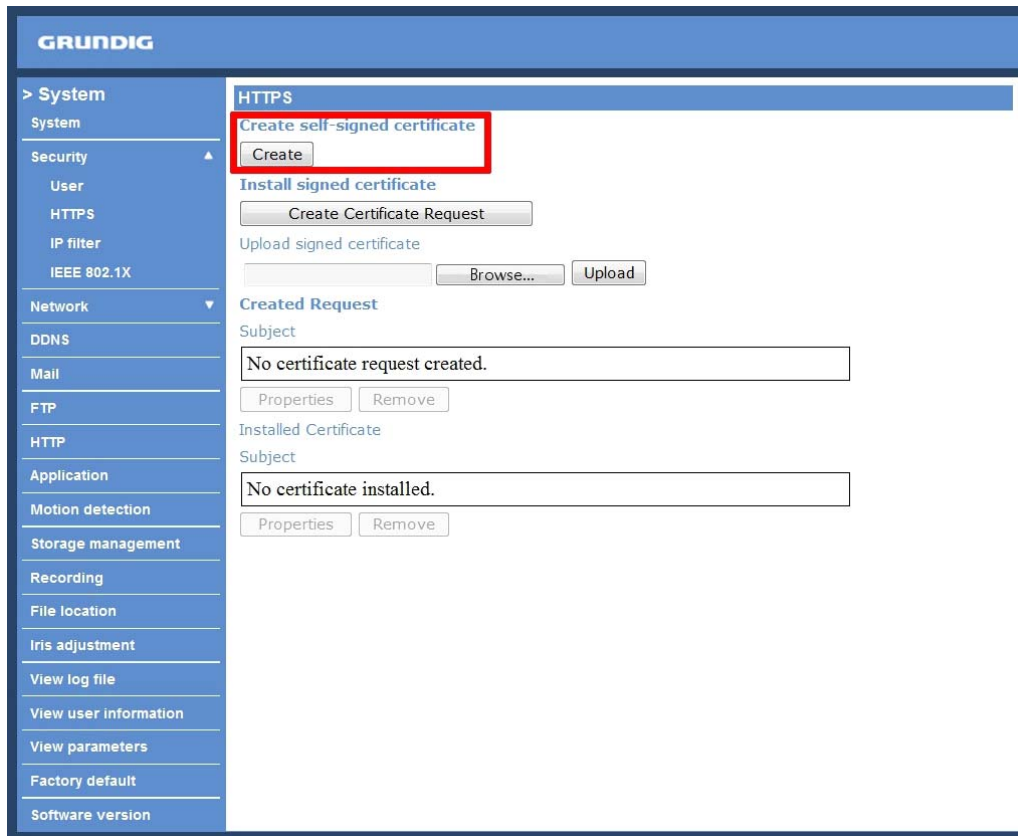

Click the <Create> button under “Create self-signed certificate” and provide the requested information to install a self-signed certificate for the IP Camera. Please refer to the last part of this section: Provide the Certificate Information for more details.

NOTE: The self-signed certificate does not provide the same high level of security as when using a CA-issued certificate.

Provide the requested information in the Create Dialog. Please refer to the following Provide the Certificate Information for more details.

## Create Certificate Request :

Click the "Create Certificate Request" button to create and submit a certificate request in order to obtain a signed certificate from CA.

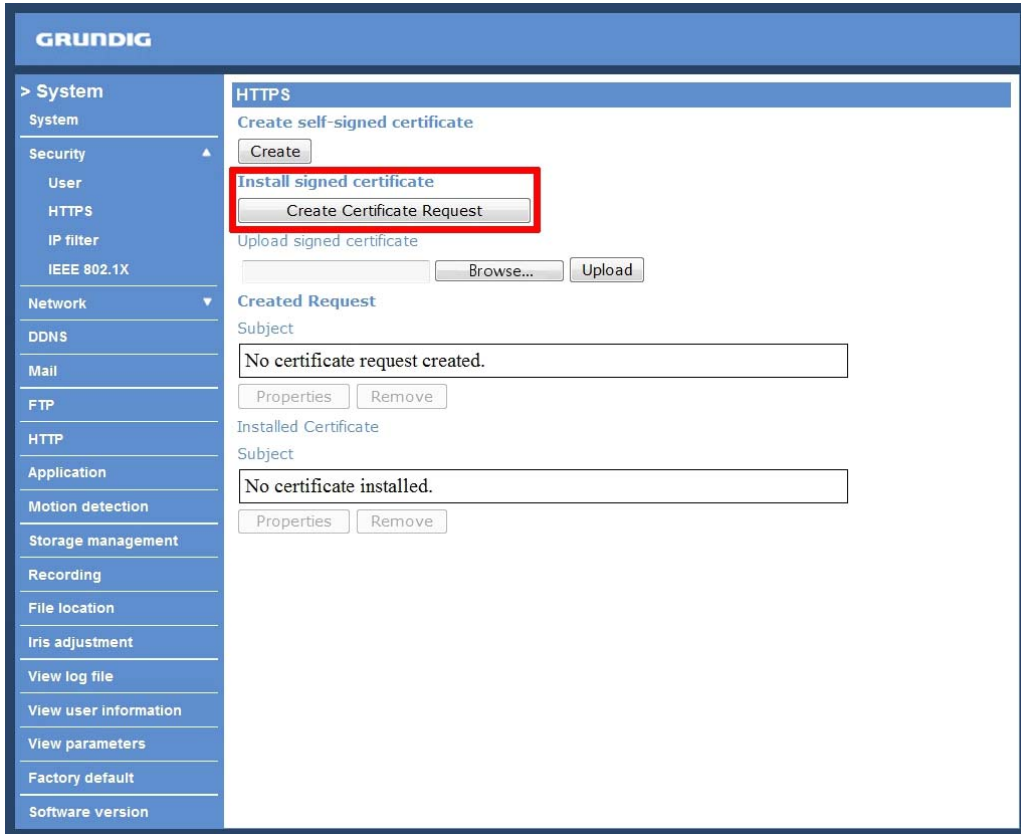

When the request is complete, the subject of the Created Request will be shown in the field. Click "Properties" below the Subject field, copy the PEM-formatted request and send it to your selected CA.

When the signed certificate is returned, install it by uploading the signed certificate.

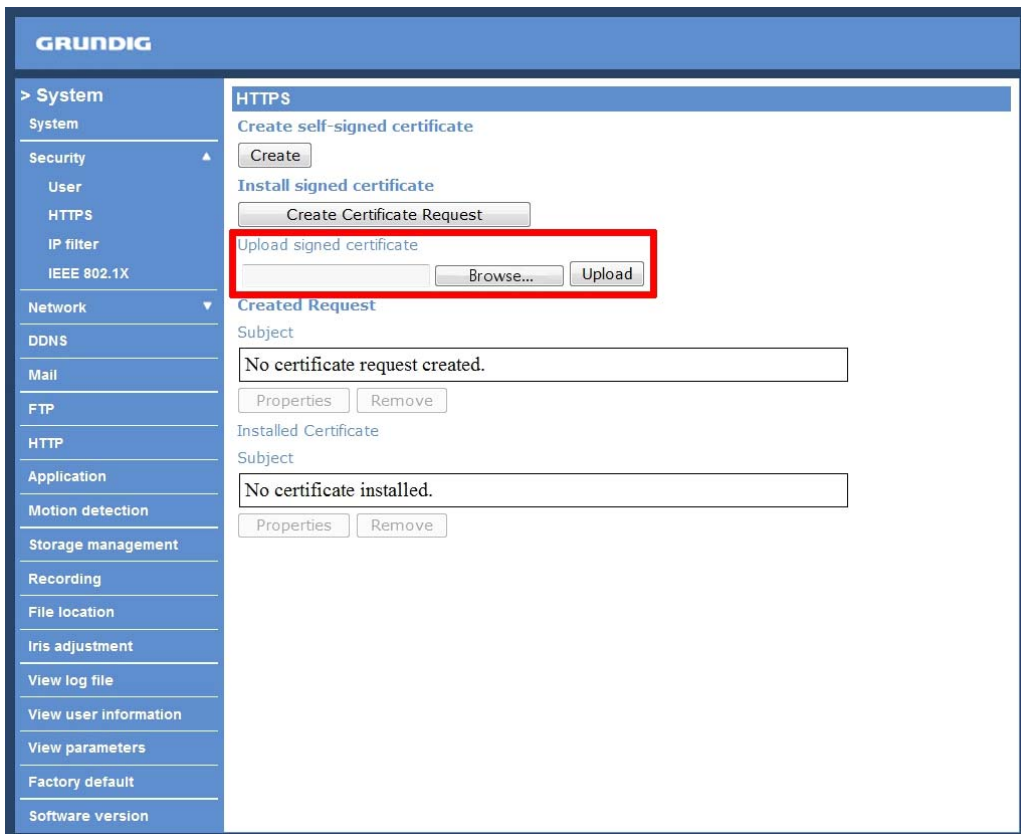

---

Provide the Certificate Information :

To create a Self-signed HTTPS Certificate or a Certificate Request to CA, please enter the information as requested:

The screenshot shows a web browser window with the address bar displaying `http://192.168.7.123/lang1/server_certificate.html`. The page title is "Create Self-Signed Certificate". The form contains the following fields:

- Country:
- State or province:
- Locality:
- Organization:
- Organizational Unit:
- Common Name:
- Valid days:  days[1...9999]

At the bottom of the form are "OK" and "Cancel" buttons.

The screenshot shows a web browser window with the address bar displaying `http://192.168.7.123/lang1/server_createrequest.html`. The page title is "Create Certificate Request". The form contains the following fields:

- Country:
- State or province:
- Locality:
- Organization:
- Organizational Unit:
- Common Name:

At the bottom of the form are "OK" and "Cancel" buttons.

- Country:

Enter a 2-letter combination code to indicate the country the certificate will be used in. For instance, type in "GB" to indicate Great Britain.

- State or province:

Enter the local administrative region.

- Locality:

Enter other geographical information.

- Organisation:

Enter the name of the organisation to which the entity identified in "Common Name" belongs.

- Organisation Unit:

Enter the name of the organisational unit to which the entity identified in "Common Name" belongs.

- Common Name:

Indicate the name of the person or other entity that the certificate identifies (often used to identify the website).

- Valid days (Self-signed Certificate Only):

Enter the period in days (1~9999) to indicate the valid period of the certificate.

Click "OK" to save the Certificate Information after completing.

<IP Filter> :

When using the IP filter, access to the IP Camera can be restricted by denying/allowing specific IP addresses.

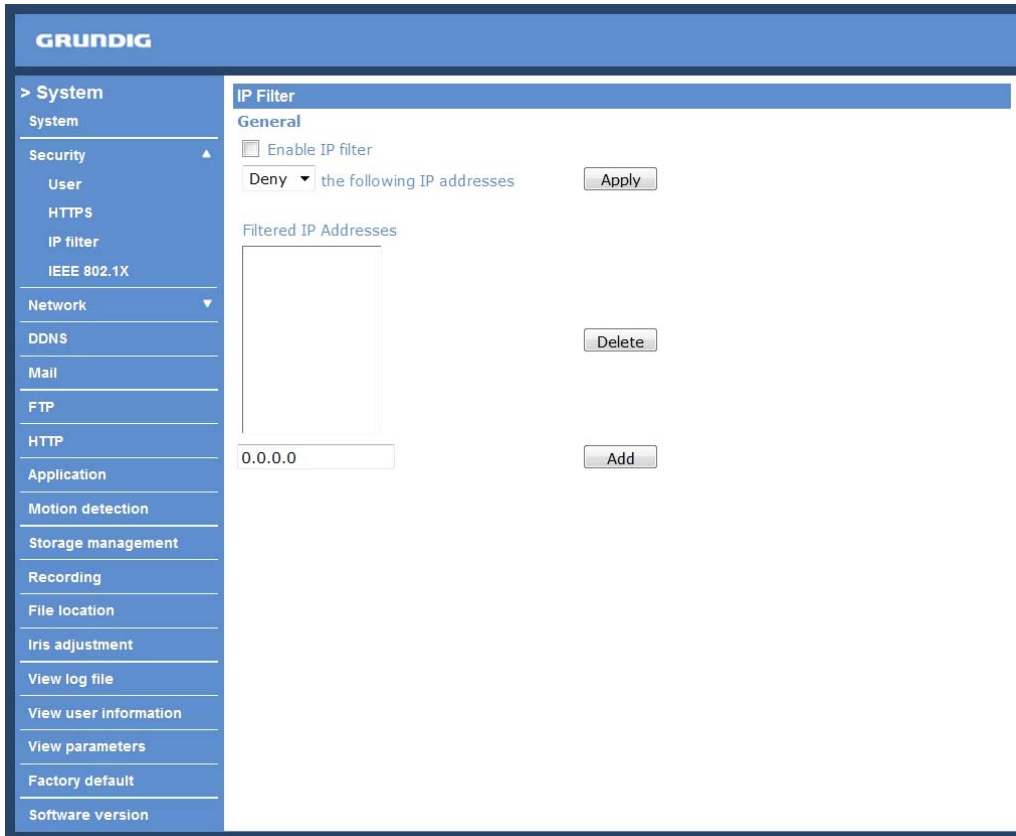

General :

- Enable IP Filter:

Check the box to enable the IP Filter function. Once enabled, the listed IP addresses (IPv4) will be allowed/denied access to the IP Camera.

Select "Allow" or "Deny" from the drop-down list and click the <Apply> button to determine the IP Filter behaviour.

- Add/Delete IP Address:

Input the IP address and click the <Add> button to add a new filtered address.

The Filtered IP Addresses list box shows the currently configured IP addresses. Up to 256 IP address entries may be specified.

To remove an IP address from the list, please select the IP and then click the <Delete> button.

<IEEE 802.1X> :

The IP Camera is allowed to access a network protected by 802.1X/EAPOL (Extensible Authentication Protocol over LAN).

Users need to contact the network administrator to receive certificates, user IDs and passwords.

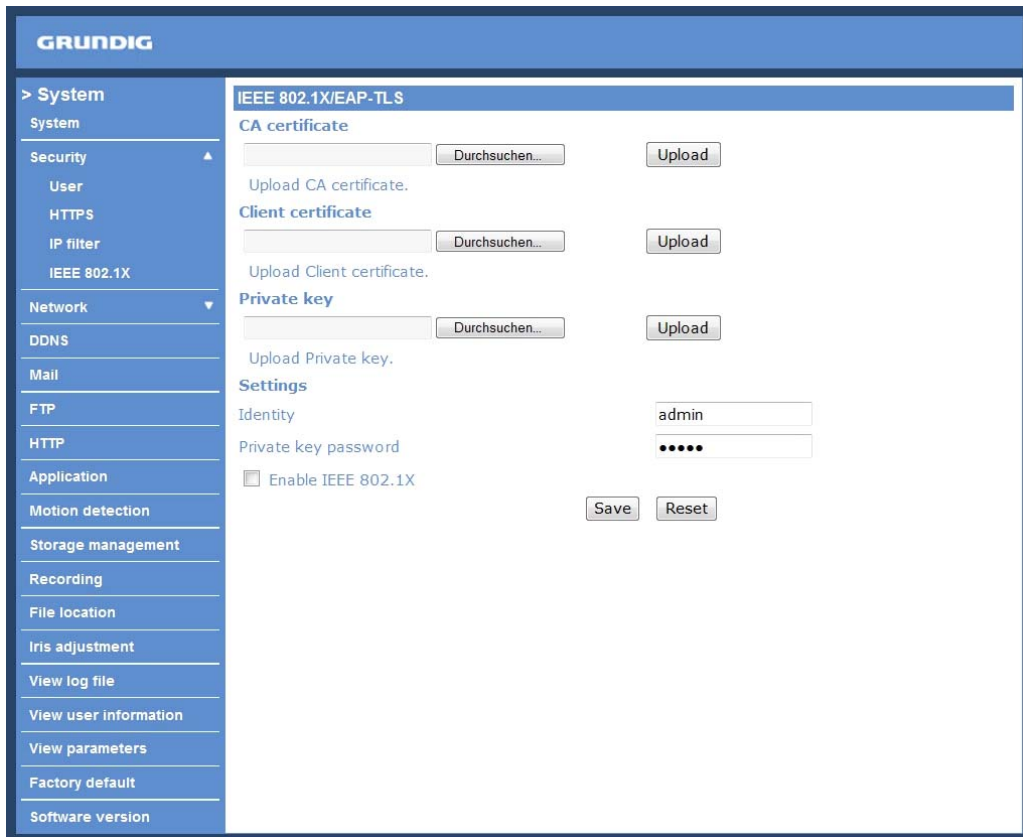

CA Certificate :

The CA certificate is created by the Certification Authority for the purpose of validating itself. Upload the certificate for checking the server's identity.

Client Certificate/Private Key :

Upload the Client Certificate and Private Key for authenticating the IP Camera itself.

Settings :

- Identity:

Enter the user identity associated with the certificate. Up to 16 characters can be used.

- Private Key Password:

Enter the password (maximum 16 characters) for your user identity.

Enable IEEE 802.1X :

Check the box to enable IEEE 802.1X.

Click "Save" to save the IEEE 802.1X/ EAP—TLS setting.



### 9.3. Network

Click the category: <Network>, there will be a drop-down menu with tabs including <Basic>, <QoS>, <SNMP>, and <UPnP>.

The screenshot shows the Grundig web interface for network configuration. The left sidebar contains a menu with categories: > System, System, Security, Network (expanded), Basic, QoS, SNMP, UPnP, DDNS, Mail, FTP, HTTP, Application, Motion detection, Storage management, Recording, File location, Iris adjustment, View log file, View user information, View parameters, Factory default, and Software version. The main content area is titled 'Network' and has a 'General' tab selected. Under 'General', there are two radio buttons: 'Get IP address automatically' (unselected) and 'Use fixed IP address' (selected). Below these are input fields for IP address (192.168.44.230), Subnet mask (255.255.255.0), Default gateway (192.168.44.1), Primary DNS (0.0.0.0), and Secondary DNS (0.0.0.0). There is also a section for 'Use PPPoE' with fields for User name and Password, and a 'Save' button. Below that is an 'Advanced' section with fields for Web Server port (80), RTSP port (554), MJPEG over HTTP port (8008), and HTTPS port (443), with another 'Save' button. At the bottom is an 'IPv6 Address Configuration' section with a checkbox for 'Enable IPv6' (unchecked) and an 'Address' field with a 'Save' button.

<Basic> :

Users can choose to connect to the IP Camera through a fixed or dynamic (DHCP) IP address. The IP Camera also provides PPPoE (Point-to-Point Protocol over Ethernet) support for users who connect to the network via PPPoE.

This screenshot is identical to the one above, showing the Grundig Network configuration page. The 'General' tab is selected, and the configuration options for fixed IP address, PPPoE, and advanced settings are visible. The 'Basic' tab in the left sidebar is highlighted, indicating it is the active view.

Get IP address automatically (DHCP):

The camera's default setting is "Use fixed IP address". Please refer to the previous section 6. Accessing the Camera for login with the default IP address.

If "Get IP address automatically" is selected, after the IP Camera restarts, users can search the IP address through the installer program "GRUNDIG Finder.exe", which can be found in the "GRUNDIG Finder" folder on the supplied CD.

NOTE: Please make a record of the IP Camera's MAC address, which can be found in the label of the camera, for identification in the future.

Use a fixed IP address :

To setup a static IP address, select "Use fixed IP address" and move the cursor to the IP address blank (as indicated below) and insert the new IP address, e.g. 192.168.7.123; then go to the Default Gateway (explained later) and type in the appropriate setting, e.g. 192.168.7.254. Press "Save" to confirm the new setting.

The screenshot shows the Grundig web interface for network configuration. On the left is a navigation menu with categories like System, Security, Network, and Application. The 'Network' section is expanded to show 'General' settings. Under 'General', the 'Use fixed IP address' radio button is selected. The 'IP address' field is set to 192.168.44.230, the 'Subnet mask' is 255.255.255.0, and the 'Default gateway' is 192.168.44.1. Below these are fields for Primary and Secondary DNS, both set to 0.0.0.0. There are also fields for 'User name' and 'Password' under the 'Use PPPoE' section. An 'Advanced' section contains ports for Web Server (80), RTSP (554), MJPEG over HTTP (8008), and HTTPS (443). At the bottom, there is an 'IPv6 Address Configuration' section with an 'Enable IPv6' checkbox and an 'Address' field. A 'Save' button is highlighted with a red box at the bottom of the main configuration area.

When using a static IP address to login to the IP Camera, users can access it either through the "GRUNDIG Finder" software (see 6. Accessing the Camera) or input the IP address in the URL bar and press "Enter".

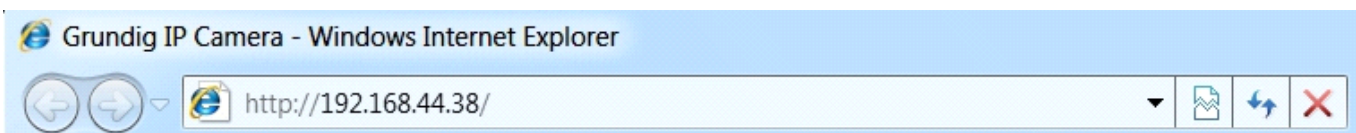

- IP address:

This is necessary for network identification.

- Subnet mask:

It is used to determine if the destination is in the same subnet. The default value is "255.255.255.0".

- Default gateway:

This is the gateway used to forward frames to destinations in different subnets. An invalid gateway setting will fail the transmission to destinations in different subnets.

- Primary DNS:

Primary DNS is the primary domain name server that translates hostnames into IP addresses.

- Secondary DNS:

Secondary DNS is a secondary domain name server that backups the primary DNS.

Use PPPoE :

For the PPPoE users, enter the PPPoE Username and Password into the fields, and click on the "Save" button to complete the setting.

Advanced :

- Web Server port:

The default web server port is 80. Once the port is changed, the users must be informed about the change for the connection to be successful. For instance, when the Administrator changes the HTTP port of the IP Camera whose IP address is 192.168.0.100 from 80 to 8080, the users must type in the web browser "http://192.168.0.100:8080" instead of "http://192.168.0.100".

- RTSP port:

The default setting of RTSP Port is 554; the setting range is from 1024 to 65535.

- MJPEG over HTTP port:

The default setting of MJPEG over HTTP Port is 8008; the setting range is from 1024 to 65535.

- HTTPS port:

The default setting of HTTPS Port is 443; the setting range is from 1024 to 65535.

NOTE: Be aware to assign a different port number for each separate service mentioned above.

IPv6 Address Configuration :

With IPv6 support, users can use the corresponding IPv6 address for browsing. Enable IPv6 by checking the box and click "Save" to complete the setting.

<QoS> (Quality of Service) :

QoS allows providing differentiated service levels for different types of traffic packets, which guarantees delivery of priority services especially when network congestion occurs. Adapting the Differentiated Services (DiffServ) model, traffic flows are classified and marked with DSCP (DiffServ Codepoint) values, and thus receive the corresponding forwarding treatment from DiffServ capable routers.

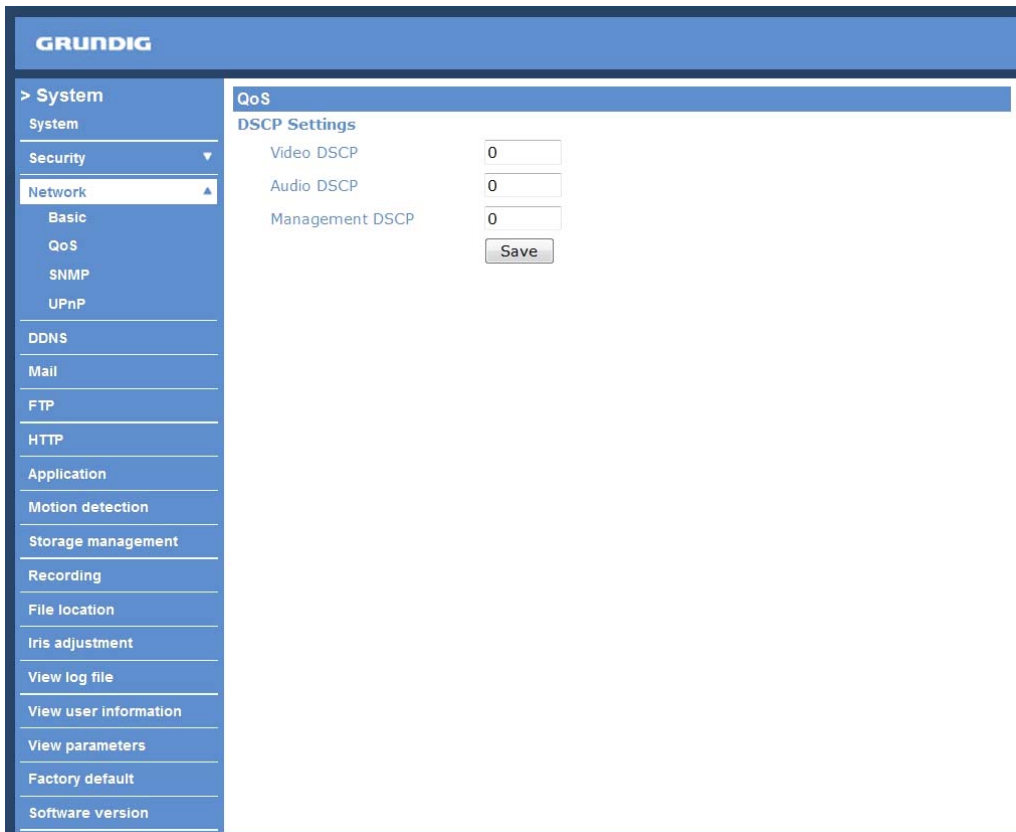

---

## DSCP Settings :

The DSCP value range is from 0 to 63. The default DSCP value is 0, which means DSCP is disabled.

The IP Camera uses the following QoS Classes: Video, Audio and Management.

### - Video:

This class consists of applications such as MJPEG over HTTP, RTP/RTSP and RTSP/HTTP.

### - Audio:

This setting is only available for the IP Cameras which support audio.

### - Management:

This class consists of HTTP traffic: Web browsing.

Click the "Save" button when complete.

NOTE: To enable this function, please make sure the switches/routers in the network support QoS.

<SNMP> (Simple Network Management Protocol) :

With Simple Network Management Protocol (SNMP) support, the IP Camera can be monitored and managed remotely by the network management system.

The screenshot shows the Grundig web interface for configuring SNMP. The left sidebar lists various system settings, with 'SNMP' selected. The main panel is titled 'SNMP Settings' and is divided into three sections: 'SNMP v1/v2', 'Traps for SNMP v1/v2', and 'Trap Options'. In the 'SNMP v1/v2' section, there are checkboxes for 'Enable SNMP v1' and 'Enable SNMP v2', and text input fields for 'Read Community' (default: public) and 'Write Community' (default: private). The 'Traps for SNMP v1/v2' section has a checkbox for 'Enable traps', and text input fields for 'Trap address' and 'Trap community' (default: public). The 'Trap Options' section has a checkbox for 'Warm start'. A 'Save' button is positioned at the bottom left of the settings area.

## SNMP v1/v2 :

### - Enable SNMP:

Select the version of SNMP to use by checking the box.

### - Read Community:

Specify the community name which has read-only access to all supported SNMP objects. The default value is "public".

### - Write Community:

Specify the community name which has read/write access to all supported SNMP objects (except read-only objects). The default value is "private".

---

### Traps for SNMP v1/v2 :

Traps are used by the IP Camera to send messages to a management system about important events or status changes.

- Enable Traps:

Check the box to activate trap reporting.

- Trap address:

Enter the IP address of the management server.

- Trap community:

Enter the community to use when sending a trap message to the management system.

Trap Option :

- Warm Start:

A Warm Start SNMP trap signifies that the SNMP device, i.e. the IP Camera, performs a software reload.

Click the "Save" button when completing.

<UPnP> :

The screenshot shows the Grundig web interface for configuring UPnP settings. The interface has a blue header with the 'GRUNDIG' logo. On the left side, there is a navigation menu with the following items: > System, System, Security, Network (with a sub-menu arrow), Basic, QoS, SNMP, UPnP, DDNS, Mail, FTP, HTTP, Application, Motion detection, Storage management, Recording, File location, Iris adjustment, View log file, View user information, View parameters, Factory default, and Software version. The main content area is titled 'UPnP' and 'UPnP Setting'. It contains two checkboxes: 'Enable UPnP' (checked) and 'Enable UPnP port forwarding' (unchecked). Below these is a text input field for 'Friendly name' containing the value 'NV062' and a 'Save' button.

UPnP Setting :

- Enable UPnP:

When the UPnP is enabled, whenever the IP Camera is presented to the LAN, the icon of the connected IP Cameras will appear in My Network Places to allow for direct access as shown below.

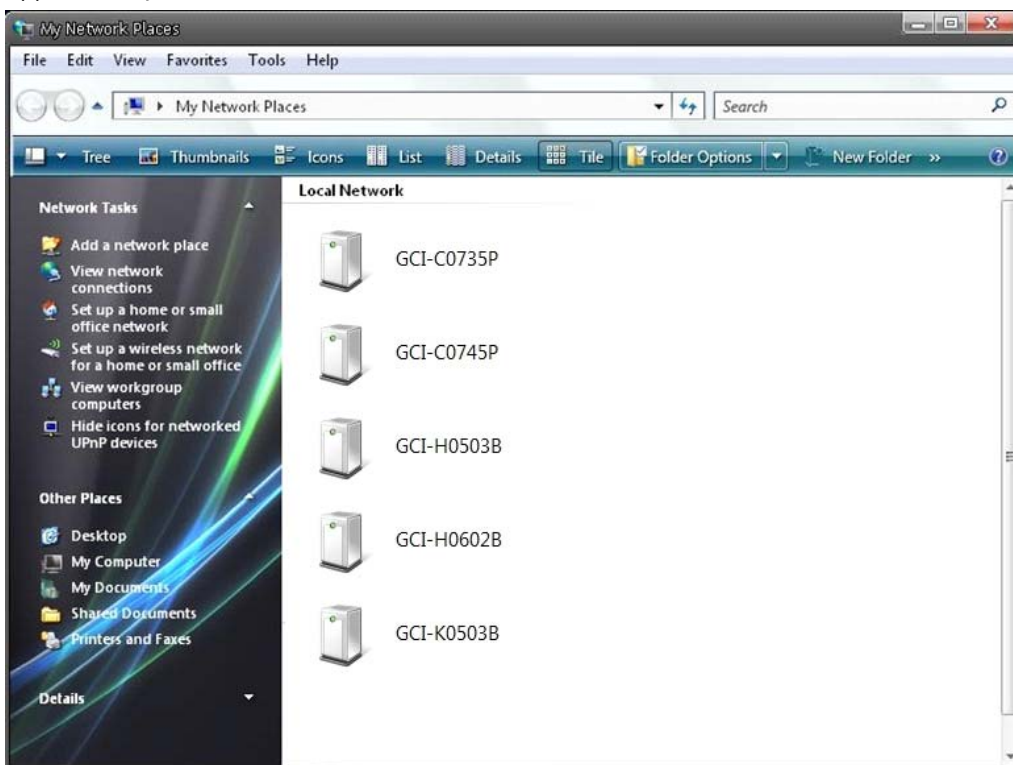

NOTE: To enable this function, please make sure the UPnP component is installed on your computer. Please refer to chapter 16. Install UPnP Components for UPnP component installation procedure.

- Enable UPnP port forwarding:

When the UPnP port forwarding is enabled, the IP Camera is allowed to open the web server port on the router automatically.

NOTE: To enable this function, please make sure that your router supports UPnP and is activated.

- Friendly name:

Set the name for the IP Camera for identity.

## 9.4. DDNS

The Dynamic Domain Name System (DDNS) allows a host name to be constantly synchronised with a dynamic IP address. In other words, it allows those using a dynamic IP address to be associated to a static domain name so that others can connect to it through this name.

The screenshot shows the Grundig DDNS configuration interface. The left sidebar lists various system settings, with 'DDNS' selected. The main panel is titled 'DDNS' and includes the following elements:

- Dynamic DNS**  
Use Dynamic DNS If You Want To Use Your DDNS Account.
- Enable DDNS
- Provider: DynDNS.org(Dynamic) (dropdown menu)
- Host name: [Text input field]
- Username/E-mail: [Text input field]
- Password/Key: [Text input field]
- Save (button)

Enable DDNS :

Check the item to enable DDNS.

Provider :

Select one DDNS host from the provider list.

Host name :

Enter the registered domain name in the field.

Username/E-mail :

Enter the username or e-mail required by the DDNS provider for authentication.

Password/Key :

Enter the password or key required by the DDNS provider for authentication.

## 9.5. Mail

The Administrator can send an e-mail via Simple Mail Transfer Protocol (SMTP) when a motion is detected. SMTP is a protocol for sending e-mail messages between servers. SMTP is a relatively simple, text-based protocol, where one or more recipients of a message are specified and to whom the message text is transferred. The configuration page is shown below:

Mail	
SMTP	
1st SMTP (mail) server	<input type="text"/>
1st SMTP (mail) server port	25
1st SMTP account name	<input type="text"/>
1st SMTP password	<input type="text"/>
1st recipient email address	<input type="text"/>
2nd SMTP (mail) server	<input type="text"/>
2nd SMTP (mail) server port	25
2nd SMTP account name	<input type="text"/>
2nd SMTP password	<input type="text"/>
2nd recipient email address	<input type="text"/>
Sender email address	<input type="text"/>
<input type="button" value="Save"/>	

Two sets of SMTP can be configured. Each set includes SMTP Server, Account Name, Password and E-mail Address settings. Concerning the SMTP server, contact your network service provider for more specific information.



## 9.6. FTP

The Administrator can set to sending alarm messages to a specific File Transfer Protocol (FTP) site when motion is detected. Users can assign an alarm message to up to two FTP sites. The FTP setting page is shown below. Enter the FTP details, which include server, server port, user name, password and remote folder, in the fields. Press "Save" when finished.

**GRUNDIG**

> System

- System
- Security
- Network
- DDNS
- Mail
- FTP**
- HTTP
- Application
- Motion detection
- Storage management
- Recording
- File location
- Iris adjustment
- View log file
- View user information
- View parameters
- Factory default
- Software version
- Software upgrade
- Maintenance
- < Back

**FTP**

FTP

Built-in FTP server port: 21

1st FTP server: [text field]

1st FTP server port: 21

1st FTP user name: [text field]

1st FTP password: [text field]

1st FTP remote folder: [text field]

1st FTP passive mode

2nd FTP server: [text field]

2nd FTP server port: 21

2nd FTP user name: [text field]

2nd FTP password: [text field]

2nd FTP remote folder: [text field]

2nd FTP passive mode

Save

## 9.7. HTTP

A HTTP Notification server can listen for notification messages from IP Cameras by triggered events. The HTTP setting page is shown below. Enter the HTTP details, which include server, user name, and password in the fields. <Alarm> triggered and <Motion Detection> notifications can be sent to the specified <HTTP> server.

Click "Save" when finished.

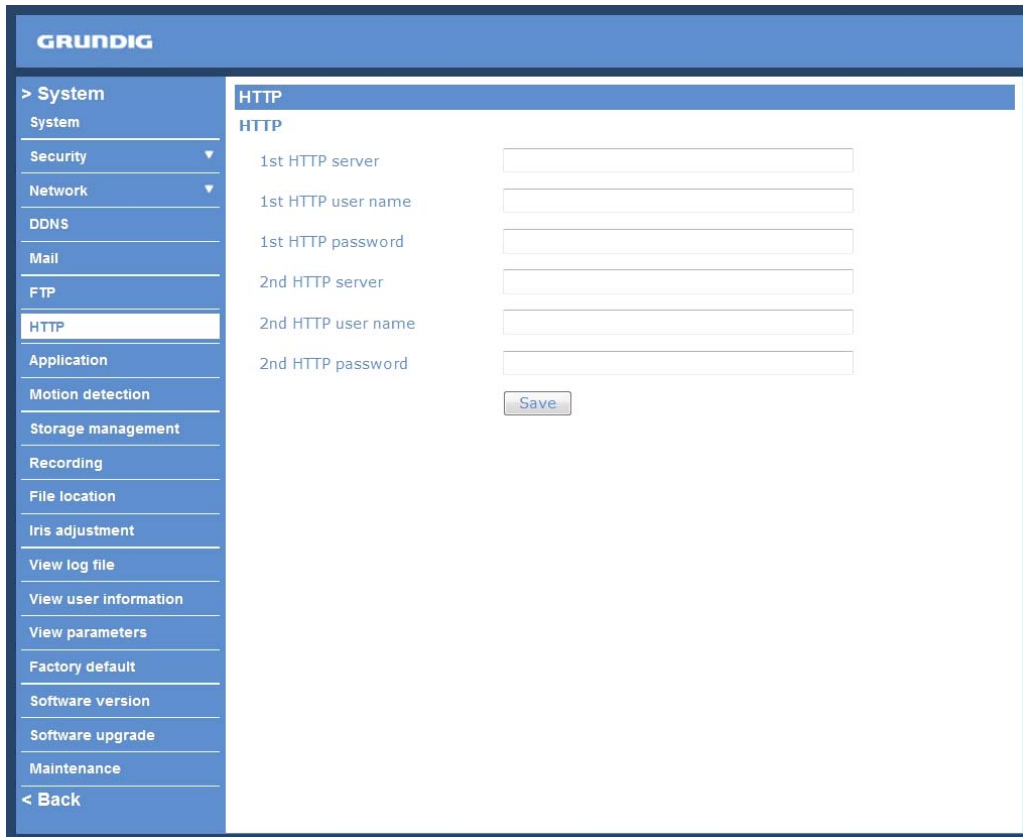

Please refer to: 9.8. Application: Send HTTP notification / 9.9. Motion Detection for HTTP Notification settings.

## 9.8. Application (Alarm Settings)

The IP Camera equips one alarm input and one relay output for cooperating with the alarm system to catch events' images. Refer to the alarm pin definition below to connect alarm devices to the IP Camera if needed. The alarm configuration page is also shown below.

Alarm Pin Definition :

PIN 1: Output+

PIN 2: Output-

PIN 3: Input+

PIN 4: Input-

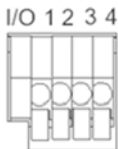
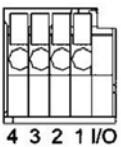

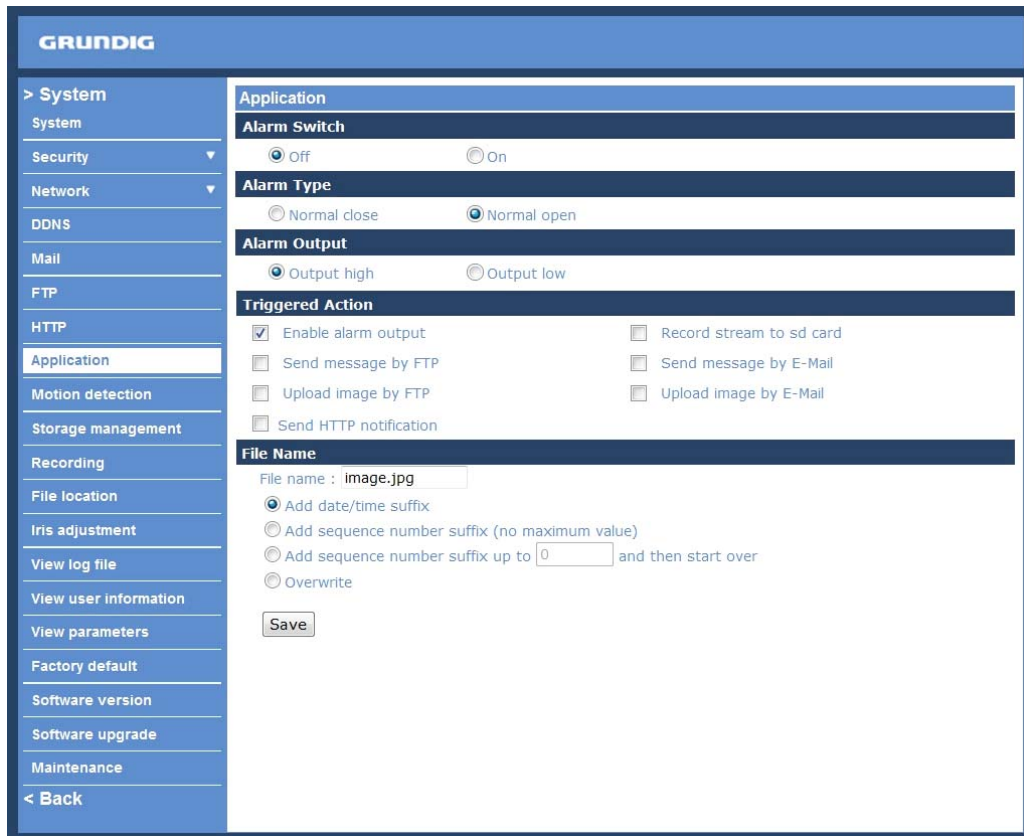

#### Alarm Switch :

The Administrator can enable or disable the alarm function.

#### Alarm Type :

Select an alarm type, "Normal close" or "Normal open", that corresponds with the alarm application.

#### Alarm Output :

Define alarm output signal as "high" or "low" for the normal alarm output status according to the current alarm application.

#### Triggered Action (Multi-option) :

The Administrator can specify alarm actions that will take place when motion is detected. All options are listed as follows:

##### - Enable Alarm Output:

Select the item to enable alarm relay output.

##### - Send Alarm Message by FTP/E-Mail:

The Administrator can choose to send an alarm message by FTP and/or by E-Mail when a motion is detected.

- Upload Image by FTP:

Select this item, and the Administrator can assign a FTP site and configure various parameters as shown in the figure below. When the alarm is triggered, event images will be uploaded to the appointed FTP site.

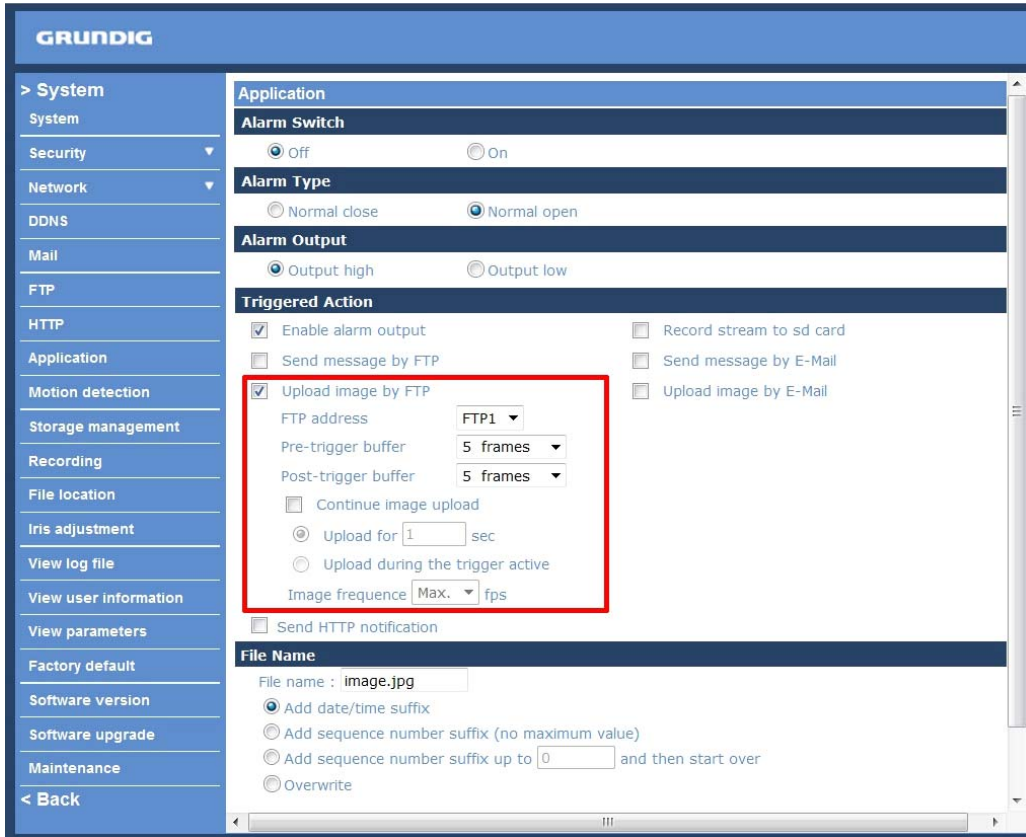

- Record Stream to SD Card:

Select the item, and the alarm-triggered recording will be saved on your Micro SD card.

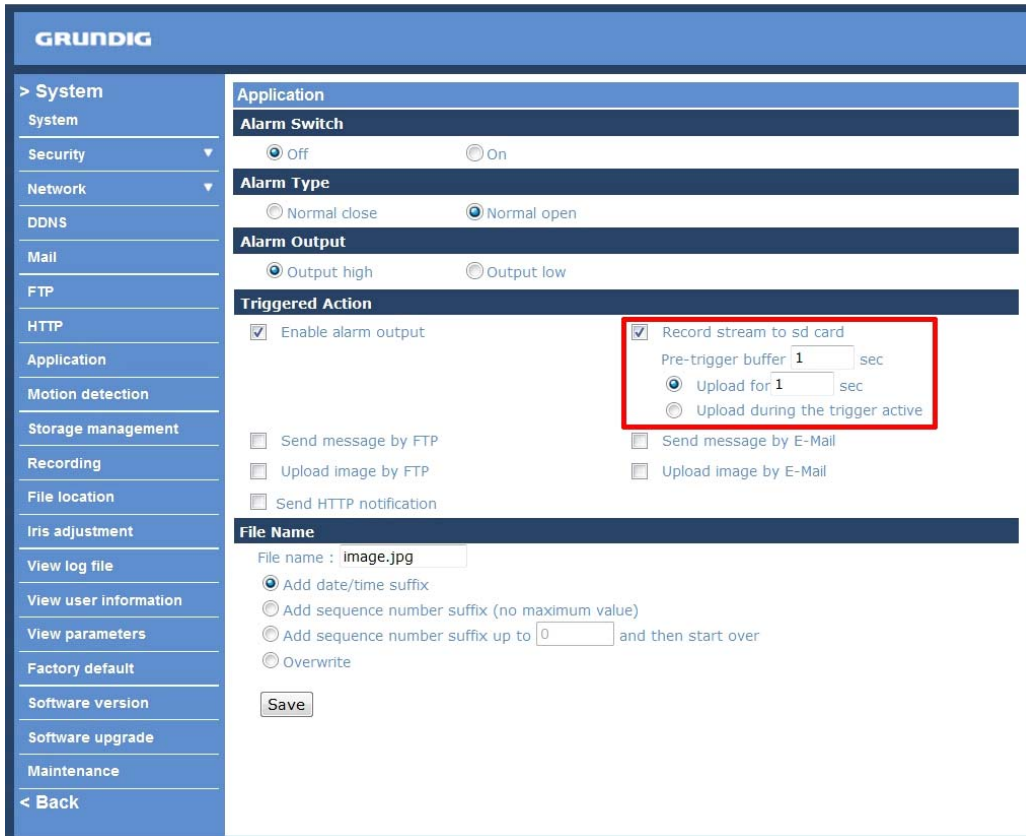

NOTE: Please make sure the local recording (with Micro SD/ SDHC card) is activated so that this function can be implemented. See section 9.12. Recording for further details.

- Upload Image by E-Mail:

Select this item, and the Administrator can assign an e-mail address and configure various parameters as shown in the figure below. When the alarm is triggered, event images will be sent to the appointed e-mail address.

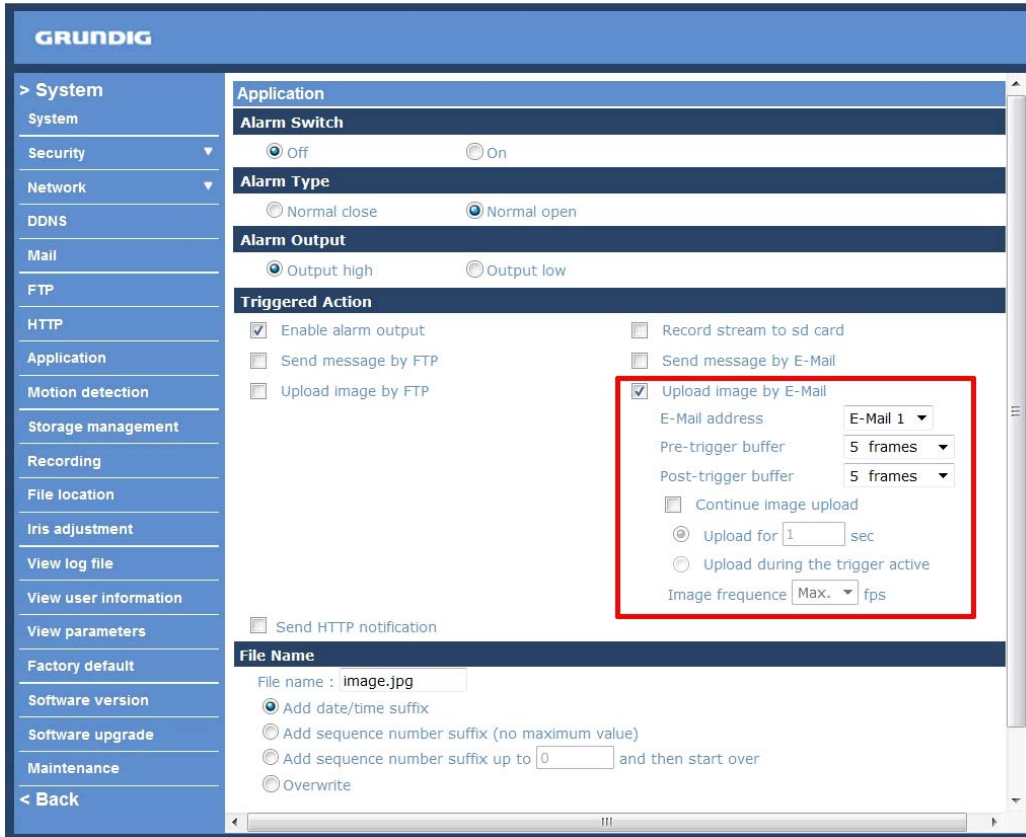

NOTE: Make sure SMTP or FTP configuration has been completed. See section 9.5. Mail and 9.6. FTP for further details.

- Send HTTP notification:

Check this item, select the destination HTTP address, and specify the parameters for event notifications when <Alarm> is triggered. When an alarm is triggered, the notification can be send to the specified HTTP server.

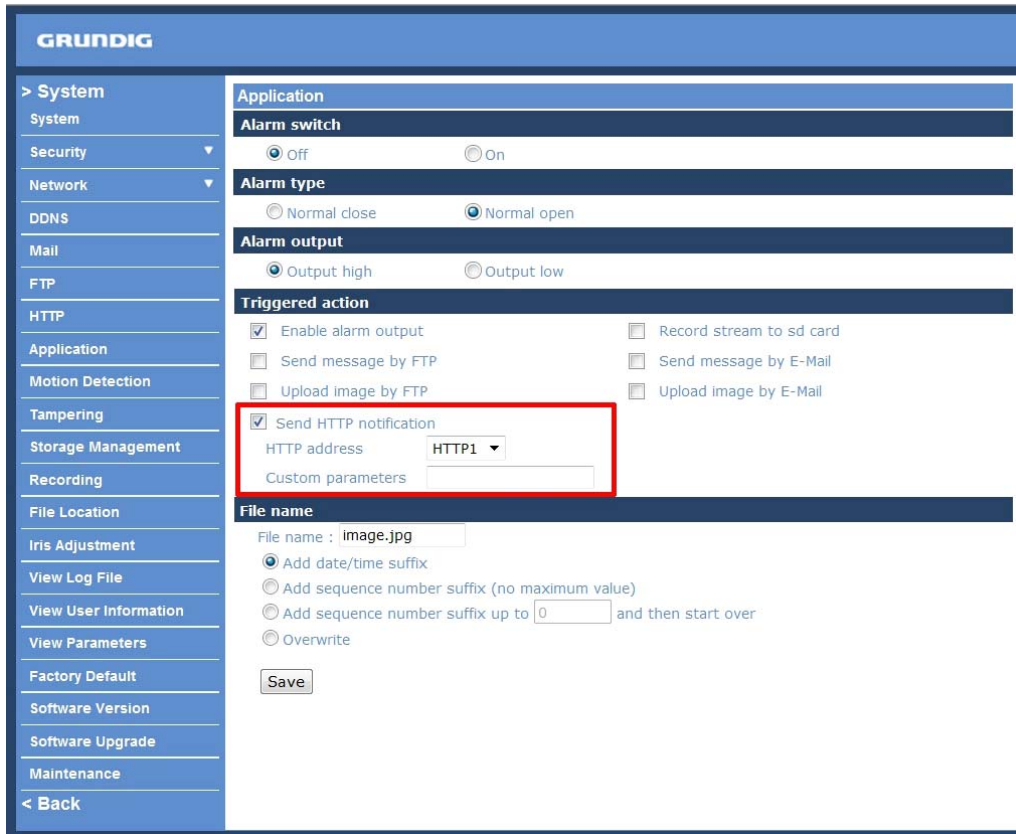

File Name :

Enter a file name into the blank box, e.g. image.jpg. The uploaded image's file name format can be set in this section. Please select the one that meets your requirements.

- Add date/time suffix:

File name: imageYYMMDD\_HHNNSS\_XX.jpg

Y: Year, M: Month, D: Day

H: Hour, N: Minute, S: Second

X: Sequence Number

- Add sequence number suffix (no maximum value):

File name: imageXXXXXX.jpg

X: Sequence Number

- Add sequence number suffix up to \_ and then start over:

File Name: imageXX.jpg

X: Sequence Number

The file name suffix will end at the number being set. For example, if the setting is "10" the file name will start from 00, end at 10, and then start all over again.

- Overwrite:

The original image in the FTP site will be overwritten by the new uploaded file with a static filename.

Save :

After completing all the settings mentioned above, please click on the Save button to save all the settings in this page.

## 9.9. Motion Detection

The Motion Detection function allows detecting suspicious motion and triggering alarms when motion volume in the detected area reaches/exceeds the determined sensitivity threshold value.

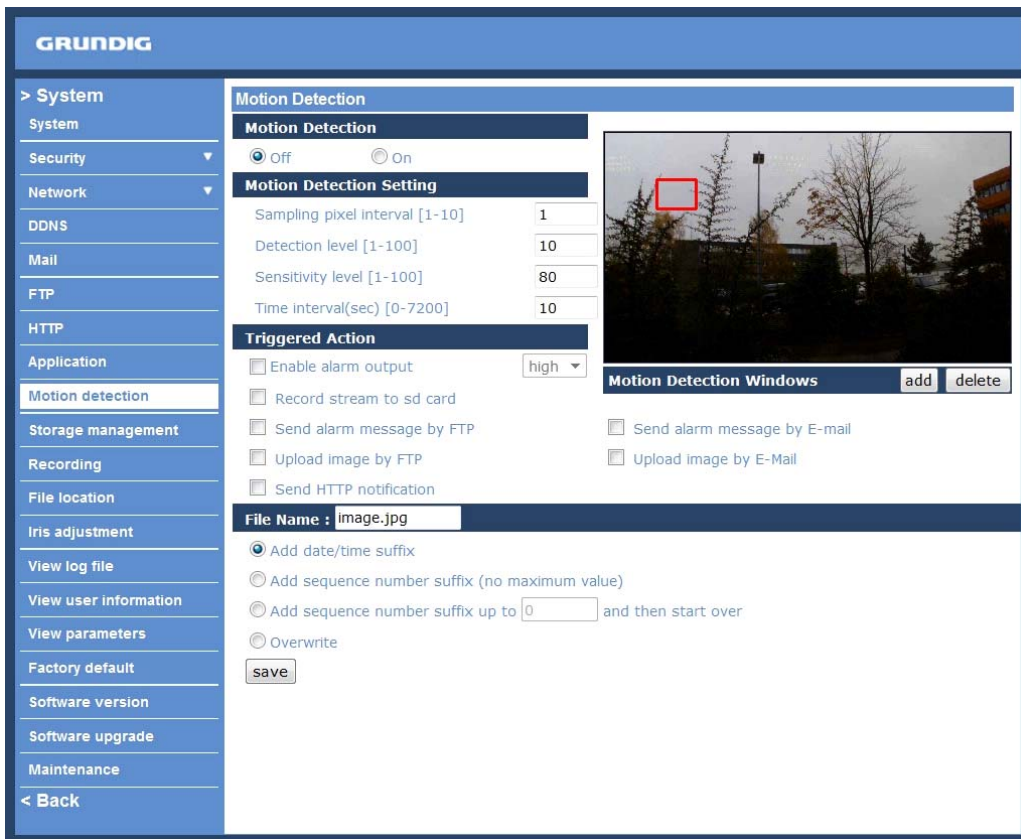

In the Motion Detection setting page is a frame (Motion Detection Window) displayed in the Live View Pane. The Motion Detection Window is for defining the motion detection area. To change the size of the Motion Detection Window, move the mouse cursor to the edge of the frame and draw it outward/inward. Moving the mouse to the center of the frame can shift the frame to the intended location.

Up to 10 Motion Detection Windows can be set. Press the “add” button under the Live View Pane to add a Motion Detection Window. To cancel a Motion Detection Window, move the mouse cursor to the selected Window, and click on the “delete” button.

If the Motion Detection function is activated, the pop-up window (Motion) with indication of motion will be shown.



---

When motion is detected, the signals will be displayed in the Motion window as shown below:



Detailed settings of Motion Detection are described as follows:

**Motion Detection :**

You will be able to turn on/off Motion Detection in the System section: Motion Detection. The default setting is Off.

**Motion Detection Setting :**

Users can adjust various parameters of Motion Detection in this section.

- Sampling pixel interval [1-10]:

The default value is 10, which means the system will take one sampling pixel for every 10 pixel.

- Detection level [1-100]:

The default level is 10. This item is to set the detection level for each sampling pixel; the smaller the value, the more sensitive it is.

- Sensitivity level [1-100]:

The default level is 80, which means if 20% or more sampling pixels are detected as changing, the system will detect motion. The bigger the value, the more sensitive it is. Meanwhile, when the value is bigger, the red horizontal line in the motion indication window will be accordingly lower.

- Time interval (sec) [0-7200]:

The default interval is 10. This value is the interval between each detected motion.

**Triggered Action (Multi-option) :**

The Administrator can specify alarm actions that will take place when the alarm is triggered. All options are listed as follows:

- Enable Alarm Output:

Check the item and select the predefined type of alarm output to enable alarm relay output when motion is detected.

- Record stream to SD Card:

Select this item, and the Motion Detection recording will be stored on a Micro SD/SDHC card when tampering is detected.

**NOTE:** Please make sure the local recording (with Micro SD/ SDHC card) is activated so that this function can be implemented. See section 9.12. Recording for further details.

- Send Alarm Message by FTP/E-Mail:

The Administrator can choose to send an alarm message by FTP and/or by E-Mail when a motion is detected.



---

- Upload Image by FTP:

Select this item, and the Administrator can assign a FTP site and configure various parameters as shown in the picture below. When a motion is detected, event images will be uploaded to the appointed FTP site.

The screenshot shows a configuration panel for 'Upload image by FTP'. It includes a checked checkbox, a dropdown for 'FTP address' (FTP1), two dropdowns for 'Pre-trigger buffer' and 'Post-trigger buffer' (both 5 frames), an unchecked checkbox for 'Continue image upload', two radio buttons for 'Upload for 1 sec' (selected) and 'Upload during the trigger active', and a dropdown for 'Image frequency' (Max. fps).

- Upload Image by E-Mail:

Select this item, and the Administrator can assign an e-mail address and configure various parameters as shown in the picture below. When a motion is detected, event images will be sent to the appointed e-mail address.

The screenshot shows a configuration panel for 'Upload image by E-Mail'. It includes a checked checkbox, a dropdown for 'E-Mail address' (E-Mail 1), two dropdowns for 'Pre-trigger buffer' and 'Post-trigger buffer' (both 5 frames), an unchecked checkbox for 'Continue image upload', two radio buttons for 'Upload for 1 sec' (selected) and 'Upload during the trigger active', and a dropdown for 'Image frequency' (Max. fps).

- Send HTTP notification:

Check this item, select the destination HTTP address, and specify the parameters for event notifications when <Motion Detection> is triggered. When an alarm is triggered, the notification can be sent to the specified HTTP server.

The screenshot shows a configuration panel for 'Send HTTP notification'. It includes a checked checkbox, a dropdown for 'HTTP address' (HTTP1), and a text input field for 'Custom parameters'.

NOTE: Make sure SMTP or FTP configuration has been completed. See section 9.5. Mail and 9.6. FTP for further details.

File Name :

The uploaded image's filename format can be set in this section. Please select the one that meets your requirements.

Save :

Click the "Save" button to save all the Motion Detection alarm settings mentioned above.

## 9.10. Tampering

The Tampering Alarm function helps the IP Camera against tampering such as deliberate redirection, blocking, spray paint, and lens covering, etc. through video analysis and reaction to such events by sending out notifications or uploading snapshots to the specified destination(s).

The screenshot shows the Grundig web interface for the Tampering Alarm settings. On the left is a navigation menu with options: > System, System, Security, Network, DDNS, Mail, FTP, HTTP, Application, Motion Detection, Tampering, Storage Management, Recording, File Location, Iris Adjustment, View Log File, View User Information, View Parameters, Factory Default, Software Version, Software Upgrade, Maintenance, and < Back. The main content area is titled 'Tampering Alarm' and contains the following settings:

- Tampering alarm:** Radio buttons for Off (selected) and On.
- Tampering duration:** A text input field for 'Minimum duration' set to '20' with the unit 'sec'.
- Triggered action:** A grid of checkboxes and a dropdown menu:
  - Enable alarm output (dropdown menu set to 'High')
  - Record stream to sd card
  - Send message by FTP
  - Send message by E-Mail
  - Upload image by FTP
  - Upload image by E-Mail
  - Send HTTP notification
- File name:** A text input field for 'File name' containing 'image.jpg'. Below it are radio button options:
  - Add date/time suffix
  - Add sequence number suffix (no maximum value)
  - Add sequence number suffix up to [0] and then start over
  - Overwrite

A 'Save' button is located at the bottom of the settings area.

Detection of camera tampering is achieved by measuring the differences between the older frames of video (which are stored in buffers) and more recent frames.

**Tampering Alarm :**

You will be able to turn on/off the Tampering Alarm function in the Tampering Alarm setting page. The default setting is Off.

**Tampering Duration :**

The Minimum Tampering Duration is the time for video analysis to determine whether any camera tampering has occurred. Minimum Duration can also be interpreted as defining the Tampering threshold; longer duration represents a higher threshold. Settable Tampering Duration time range is from 10 to 3600 seconds.

**Triggered Action (Multi-option) :**

The Administrator can specify alarm actions that will take place when tampering is detected. All options are listed as follows:

- Enable Alarm Output:

Check this item and select the predefined type of alarm output to enable alarm relay output when tampering is detected.

- Record stream to SD Card:

Select this item, and the Tampering Alarm recording will be stored on a Micro SD/SDHC card when tampering is detected.

NOTE: Please make sure the local recording (with Micro SD/ SDHC card) is activated so that this function can be implemented. See section 9.12. Recording for further details.

- Send Alarm Message by FTP/E-Mail:

The Administrator can select whether to send an alarm message by FTP and/or E-Mail when tampering is detected.

---

NOTE: The capital letter A/M/R appearing in the very beginning of a name denotes the sort of the recording: A stands for Alarm; M stands for Motion; R stands for regular recording.

- Upload Image by FTP:

Select this item, and the Administrator can assign a FTP site and configure various parameters as shown in the figure below. When tampering is detected, event images will be uploaded to the appointed FTP site.

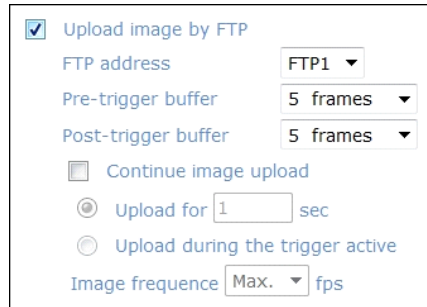

Upload image by FTP  
FTP address: FTP1  
Pre-trigger buffer: 5 frames  
Post-trigger buffer: 5 frames  
 Continue image upload  
 Upload for 1 sec  
 Upload during the trigger active  
Image frequency: Max. fps

- Upload Image by E-Mail:

Select this item, and the Administrator can assign an e-mail address and configure various parameters as shown in the figure below. When tampering is detected, event images will be sent to the appointed e-mail address.

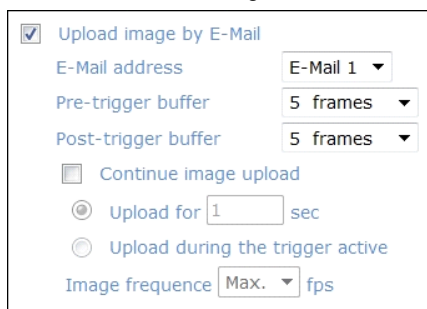

Upload image by E-Mail  
E-Mail address: E-Mail 1  
Pre-trigger buffer: 5 frames  
Post-trigger buffer: 5 frames  
 Continue image upload  
 Upload for 1 sec  
 Upload during the trigger active  
Image frequency: Max. fps

NOTE: Make sure SMTP or FTP configuration has been completed. See section 9.5. Mail and 9.6. FTP for further details.

- Send HTTP notification:

Check this item, select the destination HTTP address, and specify the parameters for HTTP notifications. When the Tampering Alarm is triggered, the HTTP notifications can be sent to the specified HTTP server.

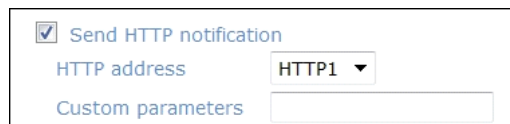

Send HTTP notification  
HTTP address: HTTP1  
Custom parameters: [ ]

File Name :

The uploaded image's filename format can be set in this section. Please select the one that meets your requirements.

Save :

Click the Save button to save all the Tampering Alarm settings mentioned above.

### 9.11. Storage Management

Users can store local recordings on a Micro SD/SDHC card up to 16 GB. This page shows the capacity information of the Micro SD card and a recording list with all the recording files saved on the memory card. Users can also format the SD card and implement automatic recording cleanup through the setting page.

To implement Micro SD card recording, please go to the "Recording" page (see 9.12. Recording) for activation.

NOTE: Please format the Micro SD/SDHC card when using it for the first time. Formatting will also be required when a memory card has already been used on one camera and was later transferred to another camera with a different software platform.

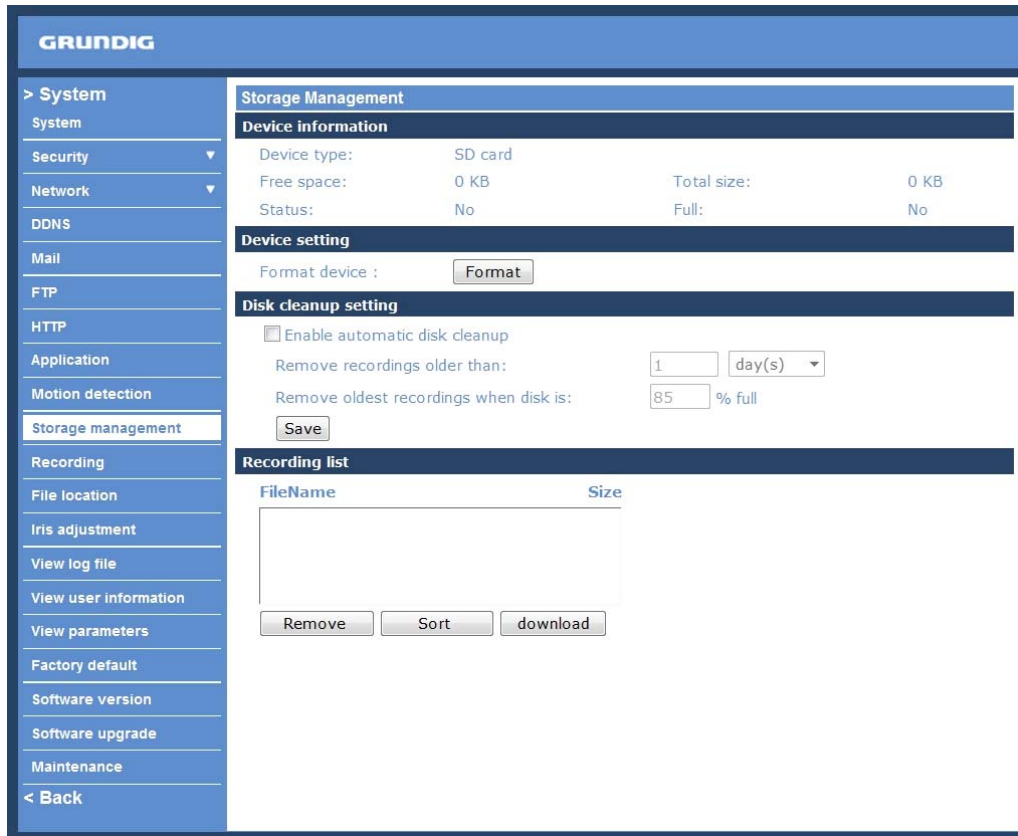

#### Device Information :

When users insert the Micro SD/SDHC card, the card information such as the memory capacity and status will be shown in the Device Information section. For the memory card being successfully installed, its status shall be shown in the "Device information" section in the Storage Management page.

#### Device Setting :

Press the "Format" button to format the memory card.

#### Disk Cleanup Setting :

Users can enable an automatic recordings cleanup by specifying the time and storage limits.

#### Recording List :

Each video file on the Micro SD/SDHC card will be listed in the Recording list as shown below. The maximum file size is 60 MB (60 MB per file).

If the recording modus is set to Always and at the same time the event recording (when a motion detection or an alarm takes place) is also turned on, in this case, when an event occurs, the event will be recorded first, afterwards the camera will return to normal recording mode.

When the recording mode is set to “Always” (consecutive recording) and the Micro SD/SDHC card recording is also allowed to be enabled when triggered by events, once the events occur, the system will immediately implement the recorded events to the memory card. After events recording, the IP Camera will return to regular recording mode.

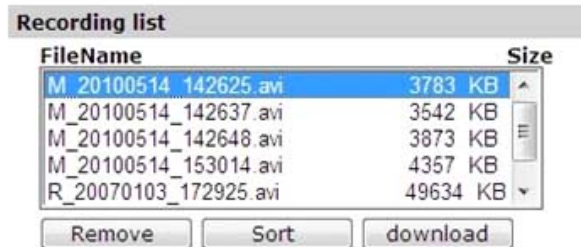

FileName	Size
M_20100514_142625.avi	3783 KB
M_20100514_142637.avi	3542 KB
M_20100514_142648.avi	3873 KB
M_20100514_153014.avi	4357 KB
R_20070103_172925.avi	49634 KB

Remove   Sort   download

- Remove:

To remove a file, select the file first, and then press the “Remove” button.

- Sort:

Press the “Sort” button, and the files in the Recording list will be listed in name and date order.

- Download:

To open/download a video clip, select the file first, and then press the “download” button below the Recording list field. The selected file window will pop up as shown below. Click on the AVI file to directly play the video in the player or download it to a specified location.

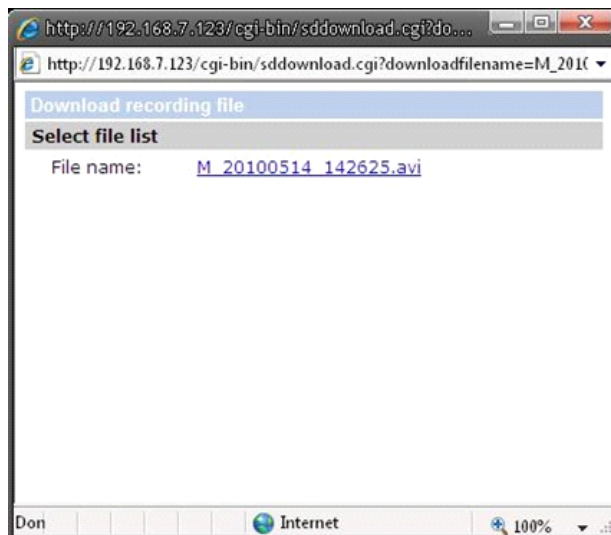

## 9.12. Recording

In the Recording setting page, users can specify the recording schedule that fits the present surveillance requirement.

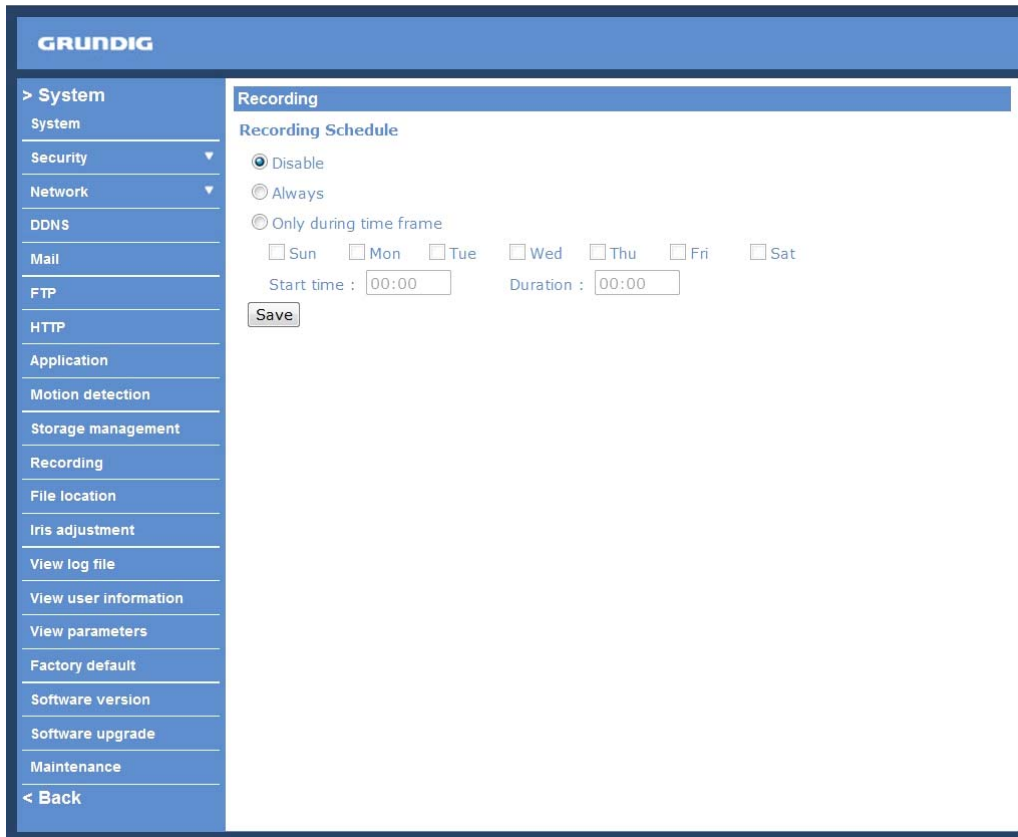

The screenshot shows the GRUNDIG web interface for configuring recording settings. On the left is a navigation menu with options: > System, System, Security, Network, DDNS, Mail, FTP, HTTP, Application, Motion detection, Storage management, Recording, File location, Iris adjustment, View log file, View user information, View parameters, Factory default, Software version, Software upgrade, Maintenance, and < Back. The main content area is titled 'Recording' and 'Recording Schedule'. It features three radio button options: 'Disable' (selected), 'Always', and 'Only during time frame'. Below these are checkboxes for days of the week: Sun, Mon, Tue, Wed, Thu, Fri, and Sat. There are also input fields for 'Start time' (00:00) and 'Duration' (00:00), and a 'Save' button.

Activating Micro SD/SDHC Card Recording :

Two types of schedule mode are offered: "Always" and "Only during time frame". Users can setup the time frame to fit the recording schedule or choose "Always" to allow the Micro SD/SDHC Card Recording to be activated all the time.

Please click on the "Save" button to confirm the schedule mode.

Terminating Micro SD/SDHC Card Recording :

Select "Disable" to terminate the recording function.

---

### 9.13. File Location

Users can specify a storage location for the snapshots and the live video recording. The default setting is: C:\. Once the setting is confirmed, press “Save,” and all the snapshots and recordings will be saved in the designate location.

NOTE: Please make sure the selected file path contains valid characters such as letters and numbers.

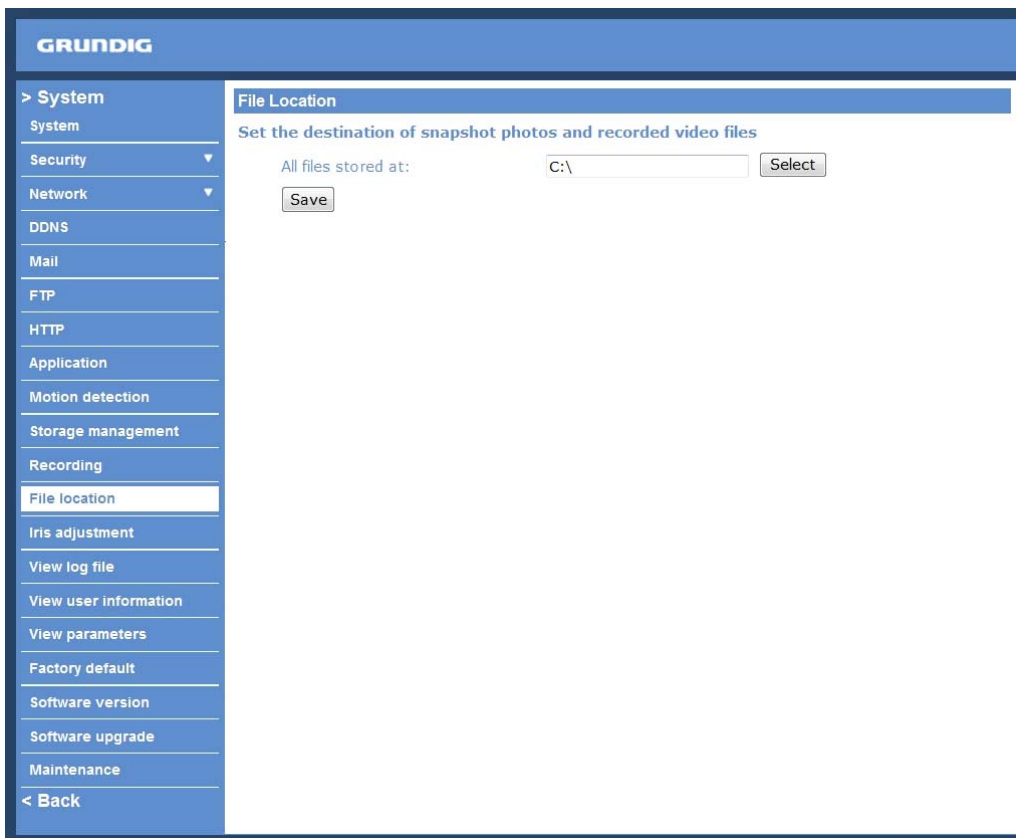

NOTE: Users with Windows 7 operating system who want to use the Snapshot or Recording function, need to follow the procedure in chapter 8. Home Page (section “Snapshot button”).

## 9.14. Iris Adjustment

For users who use an auto-iris lens, when it is required to undertake an iris adjustment, please refer to the iris adjustment procedure in the sub-menu Iris Adjustment to adjust the iris.



The screenshot shows the Grundig web interface. On the left is a navigation menu with the following items: > System, System, Security, Network, DDNS, Mail, FTP, HTTP, Application, Motion detection, Storage management, Recording, File location, Iris adjustment (highlighted), View log file, View user information, View parameters, Factory default, Software version, Software upgrade, Maintenance, and < Back. The main content area is titled 'Iris adjustment' and contains the following text: 'System will automatically adjust different auto iris lens. Follow below steps to adjust your auto iris lens.' It lists three steps: Step 1: 'Check if the auto iris lens is connected properly and adjust the lens focal length to the most wide angle of view'; Step 2: 'Shoot a high-brightness subject which will make the brightness of the whole screen uniform.'; and Step 3: 'Start the iris adjustment.' Below Step 3 is a 'Start' button.

## 9.15. View Log File

Click on the link to view the system log file. The content of this file provides useful information about configuration and connections after system boot-up.

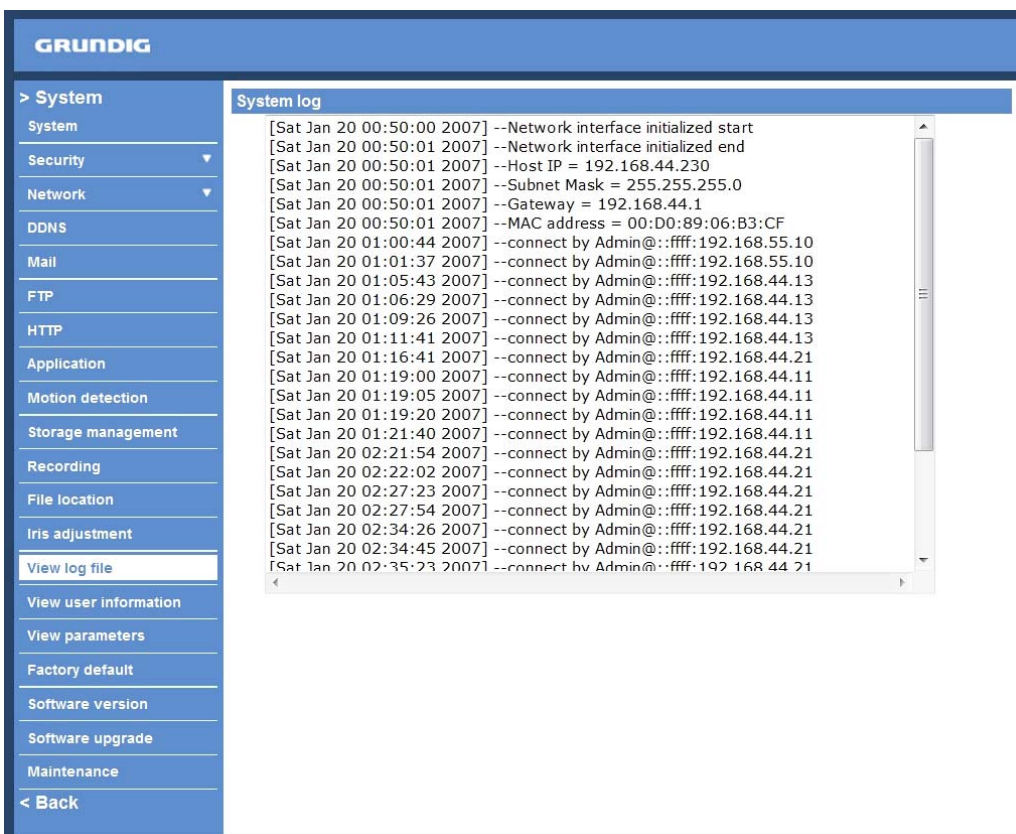

The screenshot shows the Grundig web interface with the 'View log file' option selected in the navigation menu. The main content area is titled 'System log' and displays a list of system events in a scrollable window. The log entries are as follows: [Sat Jan 20 00:50:00 2007] --Network interface initialized start; [Sat Jan 20 00:50:01 2007] --Network interface initialized end; [Sat Jan 20 00:50:01 2007] --Host IP = 192.168.44.230; [Sat Jan 20 00:50:01 2007] --Subnet Mask = 255.255.255.0; [Sat Jan 20 00:50:01 2007] --Gateway = 192.168.44.1; [Sat Jan 20 00:50:01 2007] --MAC address = 00:D0:89:06:B3:CF; [Sat Jan 20 01:00:44 2007] --connect by Admin@::ffff:192.168.55.10; [Sat Jan 20 01:01:37 2007] --connect by Admin@::ffff:192.168.55.10; [Sat Jan 20 01:05:43 2007] --connect by Admin@::ffff:192.168.44.13; [Sat Jan 20 01:06:29 2007] --connect by Admin@::ffff:192.168.44.13; [Sat Jan 20 01:09:26 2007] --connect by Admin@::ffff:192.168.44.13; [Sat Jan 20 01:11:41 2007] --connect by Admin@::ffff:192.168.44.13; [Sat Jan 20 01:16:41 2007] --connect by Admin@::ffff:192.168.44.21; [Sat Jan 20 01:19:00 2007] --connect by Admin@::ffff:192.168.44.11; [Sat Jan 20 01:19:05 2007] --connect by Admin@::ffff:192.168.44.11; [Sat Jan 20 01:19:20 2007] --connect by Admin@::ffff:192.168.44.11; [Sat Jan 20 01:21:40 2007] --connect by Admin@::ffff:192.168.44.11; [Sat Jan 20 02:21:54 2007] --connect by Admin@::ffff:192.168.44.21; [Sat Jan 20 02:22:02 2007] --connect by Admin@::ffff:192.168.44.21; [Sat Jan 20 02:27:23 2007] --connect by Admin@::ffff:192.168.44.21; [Sat Jan 20 02:27:54 2007] --connect by Admin@::ffff:192.168.44.21; [Sat Jan 20 02:34:26 2007] --connect by Admin@::ffff:192.168.44.21; [Sat Jan 20 02:34:45 2007] --connect by Admin@::ffff:192.168.44.21; [Sat Jan 20 02:35:23 2007] --connect by Admin@::ffff:192.168.44.21.



---

## 9.16. View User Information

The Administrator can view each user's login information and their privileges (see section 9.2. Security).

View User Login Information :

All the users in the network will be listed in the "User Information" zone, as shown below. The picture below shows: User: 4321

This indicates that one user's login username is: User, and the password is: 4321

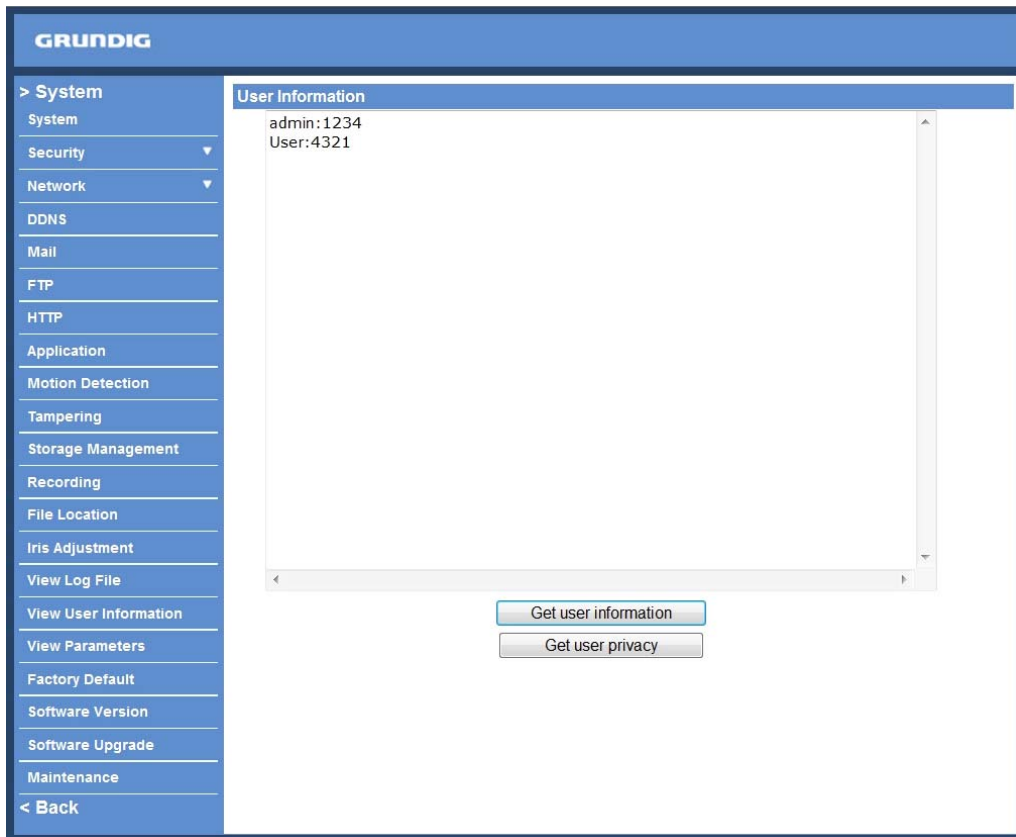

View User Privilege :

If you press "Get user privacy" at the bottom of the page, the Administrator will be able to view each user's privileges.

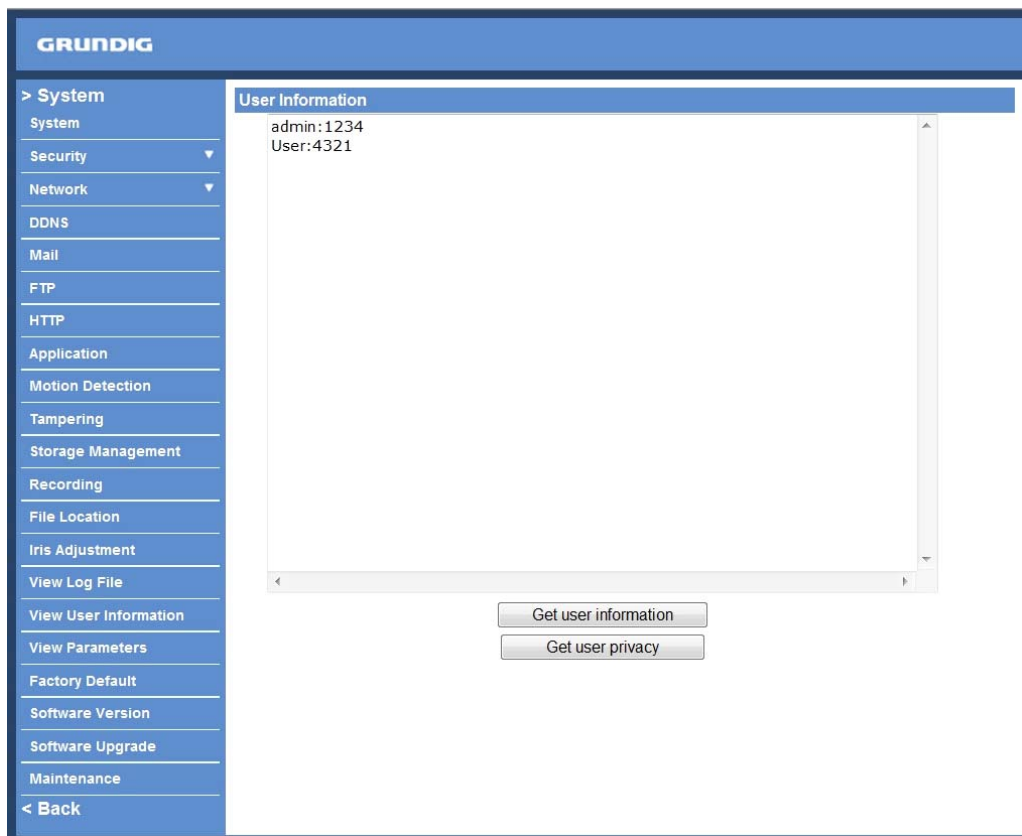

As the picture above shows: User: 1:1:0:1

1:1:0:1 = I/O access : Camera control : Talk : Listen (see 9.2. Security)

<input checked="" type="checkbox"/> I/O access	<input checked="" type="checkbox"/> Camera control
<input type="checkbox"/> Talk	<input checked="" type="checkbox"/> Listen

This denotes that the user has been granted the privileges of I/O access, Camera control and Listen.

## 9.17. View Parameters

Click on this item to view the entire system's parameter setting.

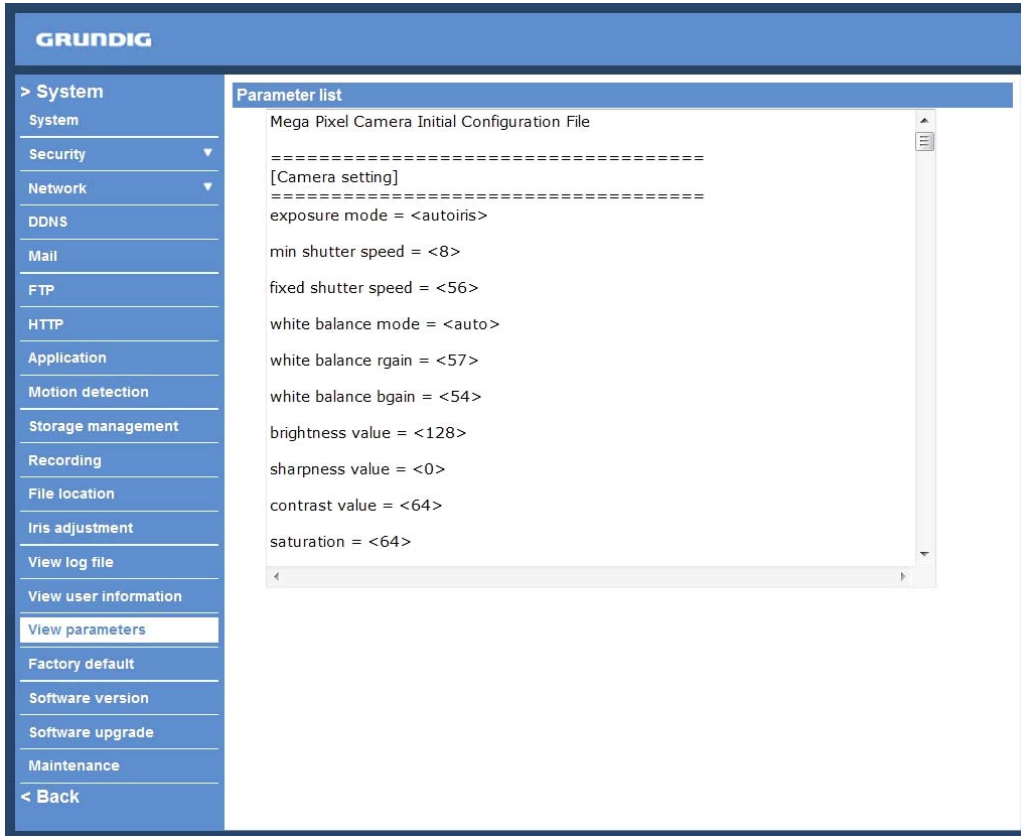

The screenshot shows the Grundig web interface. On the left is a navigation menu with the following items: > System, System, Security, Network, DDNS, Mail, FTP, HTTP, Application, Motion detection, Storage management, Recording, File location, Iris adjustment, View log file, View user information, View parameters (highlighted), Factory default, Software version, Software upgrade, Maintenance, and < Back. The main content area is titled 'Parameter list' and contains the following text:

```
Mega Pixel Camera Initial Configuration File
=====
[Camera setting]
=====
exposure mode = <autoiris>
min shutter speed = <8>
fixed shutter speed = <56>
white balance mode = <auto>
white balance rgain = <57>
white balance bgain = <54>
brightness value = <128>
sharpness value = <0>
contrast value = <64>
saturation = <64>
```

## 9.18. Factory Default

The factory default setting page is shown below. Follow the instructions to reset the IP Camera to factory default setting if needed.

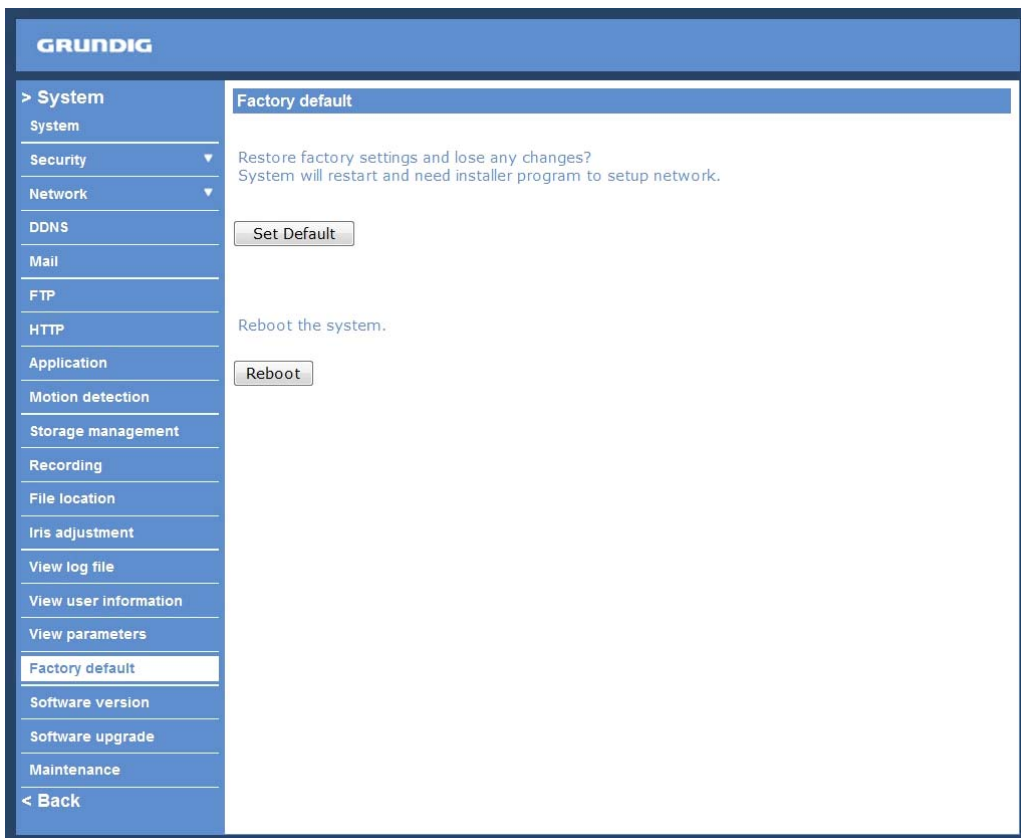

The screenshot shows the Grundig web interface. On the left is a navigation menu with the following items: > System, System, Security, Network, DDNS, Mail, FTP, HTTP, Application, Motion detection, Storage management, Recording, File location, Iris adjustment, View log file, View user information, View parameters, Factory default (highlighted), Software version, Software upgrade, Maintenance, and < Back. The main content area is titled 'Factory default' and contains the following text:

Restore factory settings and lose any changes?  
System will restart and need installer program to setup network.

Reboot the system.

---

Set Default :

Click on the “Set Default” button to recall the factory default settings. Then the system will restart in 30 seconds.

NOTE: The IP address will be restored to default.

Reboot :

Click on the “Reboot” button, and the system will restart without changing the current settings.

### 9.19. Software Version

The current software version is displayed in the software version page, which is shown in the picture below.

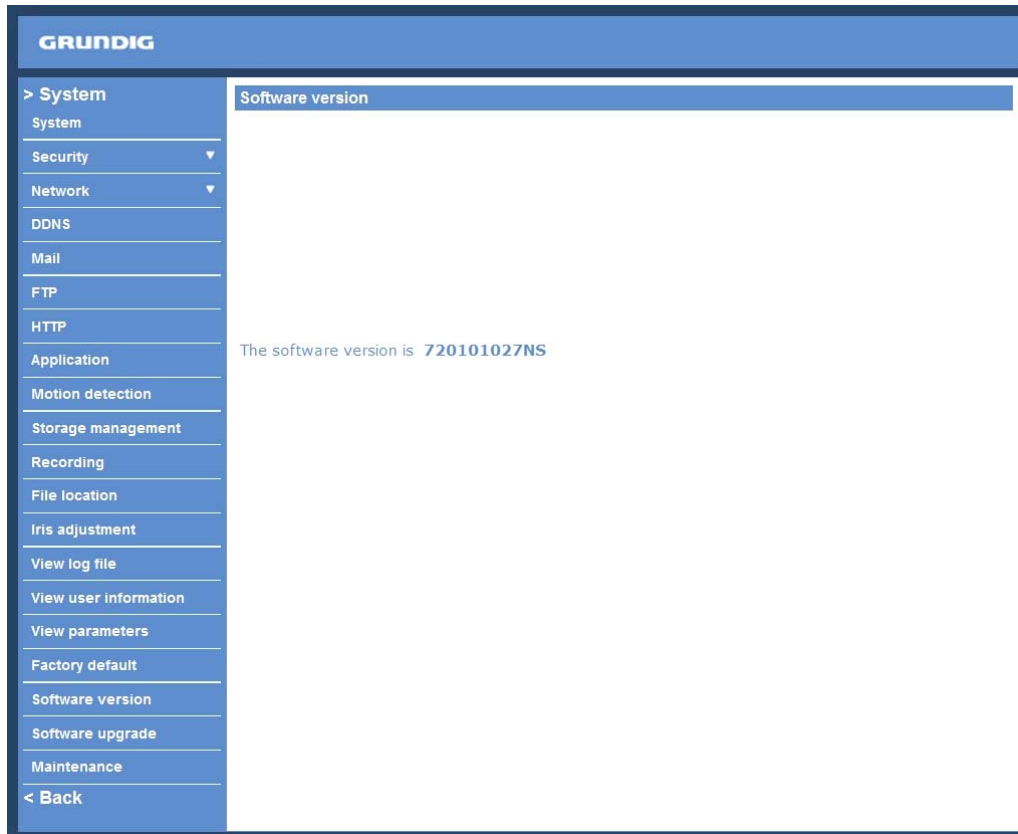

## 9.20. Software Upgrade

Software upgrade can be carried out on the “Software Upgrade” page, as shown below.

The screenshot shows the GRUNDIG web interface for software upgrade. The left sidebar contains a menu with the following items: > System, System, Security, Network, DDNS, Mail, FTP, HTTP, Application, Motion detection, Storage management, Recording, File location, Iris adjustment, View log file, View user information, View parameters, Factory default, Software version, Software upgrade, Maintenance, and < Back. The main content area is titled 'Upgrade' and contains the following steps:

- Step1:** Upload the binary file. There is a text input field and a 'Browse...' button.
- Step2:** Select binary file you want to upgrade. There is a dropdown menu with 'userland.jffs2' selected.
- Step3:** Click the upgrade button to start the upgrade process. There is an 'Upgrade' button.

NOTE: Make sure the upgrade software file is available before carrying out the software upgrade.

The procedure of a software upgrade is as follows:

Step 1: Click “Browse” and select the binary file to be uploaded, e.g. Userland.jffs2.

NOTE: Do not change the upgrade file name, or the system will fail to find the file.

Step 2: Pull down the upgrade binary file list and select the file you want to upgrade; in this case, select “userland.jffs2”.

Step 3: Press “Upgrade”. The system will first check whether the upgrade file exists or not, and then begin to upload the upgrade file. Subsequently, the upgrade status bar will display on the page. When 100% is reached, the upgrade process is finished.

After the upgrade process is finished, the viewer will return to the Home page.

Step 4: Close the video browser.

Step 5: Click “Control Panel”, and then double-click on “Add or Remove Programs.” In the “Currently installed programs” list, select “GRUNDIG Viewer” and click the button “Remove” to uninstall the existing GRUNDIG Viewer.

Step 6: Open a new web browser, re-login the IP Camera, and then allow the automatic download of the GRUNDIG Viewer.

## 9.21. Maintenance

Users can export configuration files to a specified location and retrieve data by uploading an existing configuration file to the IP Camera.

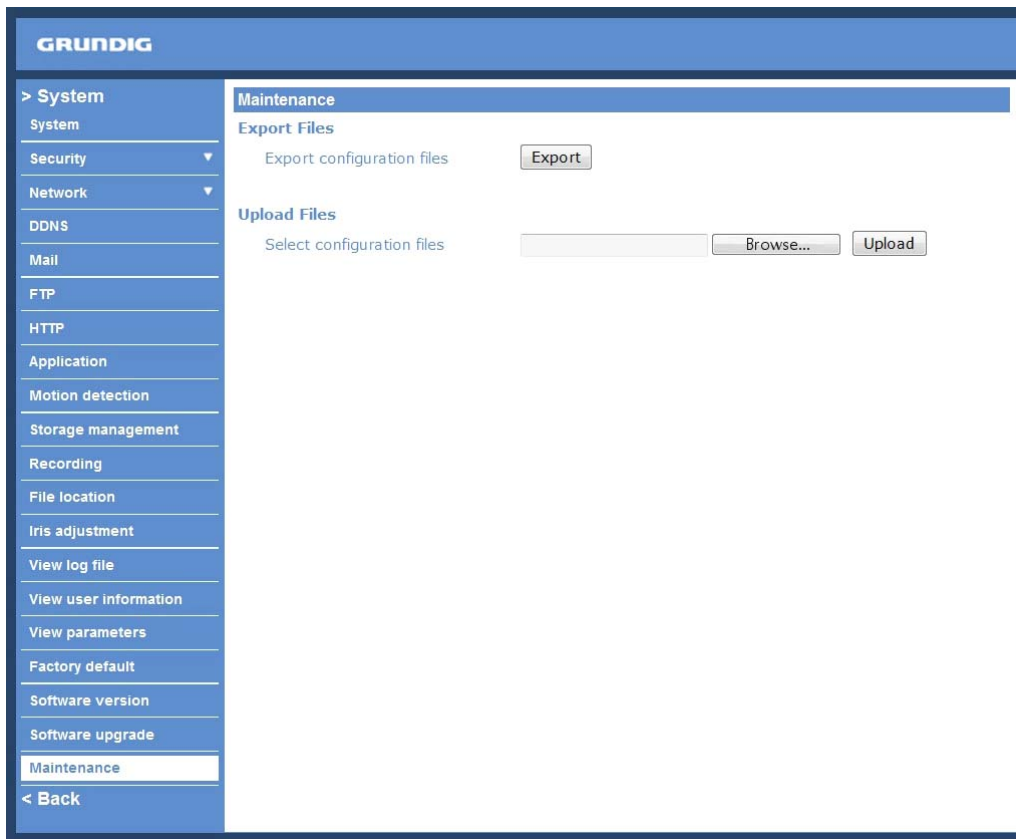

### Export:

Users can save the system settings by exporting the configuration file (.bin) to a specified location for future use. Press the “Export” button, and the popup File Download window will come up as shown below. Click “Save” and specify a desired location for saving the configuration file.



### Upload :

To copy an existing configuration file to the IP Camera, please first click on “Browse” to select the configuration file, and then press the “Upload” button for uploading.

## 10. Streaming Settings

Press the tab "Streaming" on the top of the page, and the configurable video and audio items will display in the left column. In Streaming, the Administrator can configure specific video resolution, video compression mode, video protocol, audio transmission mode, etc. Further details of these settings will be specified in the following sections.

### 10.1. Video Format

The video setting page is shown below:

**GRUNDIG**

> Streaming

- Video Format
- Video Compression
- Video OCX Protocol
- Video Frame Skip
- Video Mask
- Audio
- < Back

#### Video Format

**Video Resolution :**

MJPEG + H.264 ▾

- H.264 720p (25fps) + MJPEG 720p (25fps)
- H.264 720p (25fps) + MJPEG D1 (25fps)
- H.264 720p (25fps) + MJPEG CIF (25fps)
- H.264 720p (25fps) + MJPEG VGA (25fps)
- H.264 720p (25fps) + MJPEG QVGA (25fps)

Save

**Note :**  
Image attachment by FTP or E-mail will be available only while MJPEG streaming is selected.

**Text Overlay Settings :**

Include date       Include time

Include text string:

Save

**Video Rotate Type :**

- Normal video       Flip video
- Mirror video       180 degree rotate

Save

**GOV Settings :**

H.264-1 GOV Length :

H.264-2 GOV Length :

Save

---

#### Video Format :

Resolution for MJPEG & H.264 format includes:

- H.264 720p (25fps) + MJPEG 720p (25fps)
- H.264 720p (25fps) + MJPEG D1 (25fps)
- H.264 720p (25fps) + MJPEG CIF (25fps)
- H.264 720p (25fps) + MJPEG VGA (25fps)
- H.264 720p (25fps) + MJPEG QVGA (25fps)

For MJPEG & BNC:

- MJPEG 720p (25fps) + BNC Output

For MJPEG only:

- MJPEG 1080p (12fps)
- MJPEG SXGA (25fps)

For H.264 & H.264:

- H.264 720p (25fps) + H.264 D1 (25fps)
- H.264 720p (25fps) + H.264 CIF (25fps)
- H.264 720p (25fps) + H.264 VGA (25fps)
- H.264 720p (25fps) + H.264 VGA (25fps)
- H.264 720p (25fps) + H.264 QVGA (25fps Baseline)

For H.264 & BNC:

- H.264 720p (25fps) + BNC Output

For H.264 only:

- H.264 1080p (12fps)
- H.264 SXGA (25fps)

Click "Save" to confirm the setting.

#### Text Overlay Settings :

Users can select the items to display data including date/time/text on the live video pane. The maximum length of the string is 18 alphanumeric characters.

Click "Save" to confirm the Text Overlay setting.

#### Video Rotation Type :

Users can change the video display type if necessary. Selectable video rotate types include Normal video, Flip video, Mirror video and 180 degree rotation. Differences among these types are illustrated below.

Suppose the displayed image of IP Camera is shown as the figure below.





---

To rotate the image, users can select “Flip video”, for instance. Then the displayed image will be reversed as shown below.



The following are descriptions of different video rotation types.

- Flip video:

If select <Flip video>, the image will be rotated vertically.

- Mirror video:

If select <Mirror video>, the image will be rotated horizontally.

- 180 degree rotation:

Selecting <180 Degree rotation> will make the image 180° counter-/clockwise inversed.

Click “Save” to confirm the setting.

GOV Settings :

Users can set the GOV length to determine the frame structure (I-frames and P-frames) in a video stream for saving bandwidth. Longer GOV means decreasing the frequency of I-frames.

Click “Save” to confirm the GOV setting.

---

## 10.2. Video Compression

Users can specify the values for MJPEG/H.264 compression mode in the video compression page (see the picture below), depending on the application.

MJPEG Compression Settings:

A higher value implies higher bit rates and a higher visual quality. The default setting is 35; the setting range is from 1 to 70.

Click "Save" to confirm the setting.

H.264-1 / H.264-2 Bit Rate:

The default setting is 4096 kbps; the setting range is from 64 to 8192 kbps.

Click "Save" to confirm the setting.

The screenshot shows the Grundig web interface for video compression settings. On the left is a blue sidebar with a menu: > Streaming, Video Format, Video Compression (highlighted), Video OCX Protocol, Video Frame Skip, Video Mask, Audio, and < Back. The main content area is titled 'Video Compression' and contains several sections: 'MJPEG Compression setting :' with 'MJPEG Q factor : 35' and a 'Save' button; 'H.264-1 Compression setting :' with 'H264-1 bit rate : 4096 kbit/s' and a 'Save' button; 'H.264-2 Compression setting :' with 'H264-2 bit rate : 4096 kbit/s' and a 'Save' button; 'Compression information setting :' with a checked checkbox 'Display compression information in the home page' and a 'Save' button; and 'CBR mode setting :' with two unchecked checkboxes 'enable H.264-1 CBR mode' and 'enable H.264-2 CBR mode', and a 'Save' button.

MJPEG Q (Quality) factor :

A higher value implies higher bit rates and a higher visual quality. The default setting of the MJPEG Q factor is 35; the setting range is from 1 to 70.

H.264-1 / H.264-2 bit rate :

The default setting of H.264-1 / H.264-2 is 4096 kbps; the setting range is from 64 to 8192 kbps.

Display Compression Information :

Users can also decide whether to display compression information on the Home page.

Click "Save" to confirm the setting.

**CBR Mode Setting :**

The CBR (Constant Bit Rate) mode can become the preferred bit rate mode if the bandwidth available is limited. It is important to take into account the image quality when you choose to use CBR mode.

Click "Save" to confirm the setting.

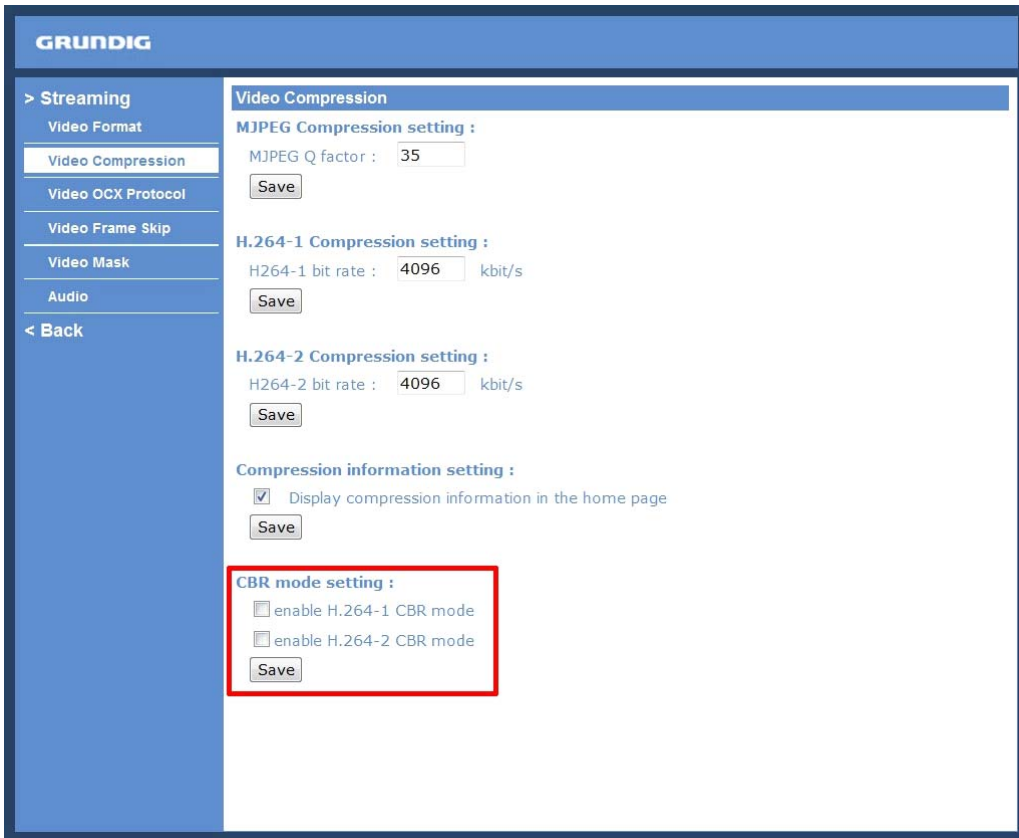

### 10.3. Video OCX Protocol

In the Video OCX protocol setting page, users can select RTP over UDP, RTP over TCP, RTSP over HTTP or MJPEG over HTTP, for streaming media over the network. In the case of multicast networking, users can select the Multicast mode. The Video OCX Protocol page is as follows:

Video OCX protocol setting options include:

- RTP over UDP / RTP over RTSP (TCP) / RTSP over HTTP / MJPEG over HTTP  
(Select a mode according to your data delivery requirements.)

- Multicast Mode:

Enter all required data, including multicast IP address, H.264 video port, MJPEG video port, audio port and TTL into each blank.

Click "Save" to confirm the setting.

---

## 10.4. Video Frame Skip

Video frame skipping is for saving bandwidth if necessary. The setting page is shown below.

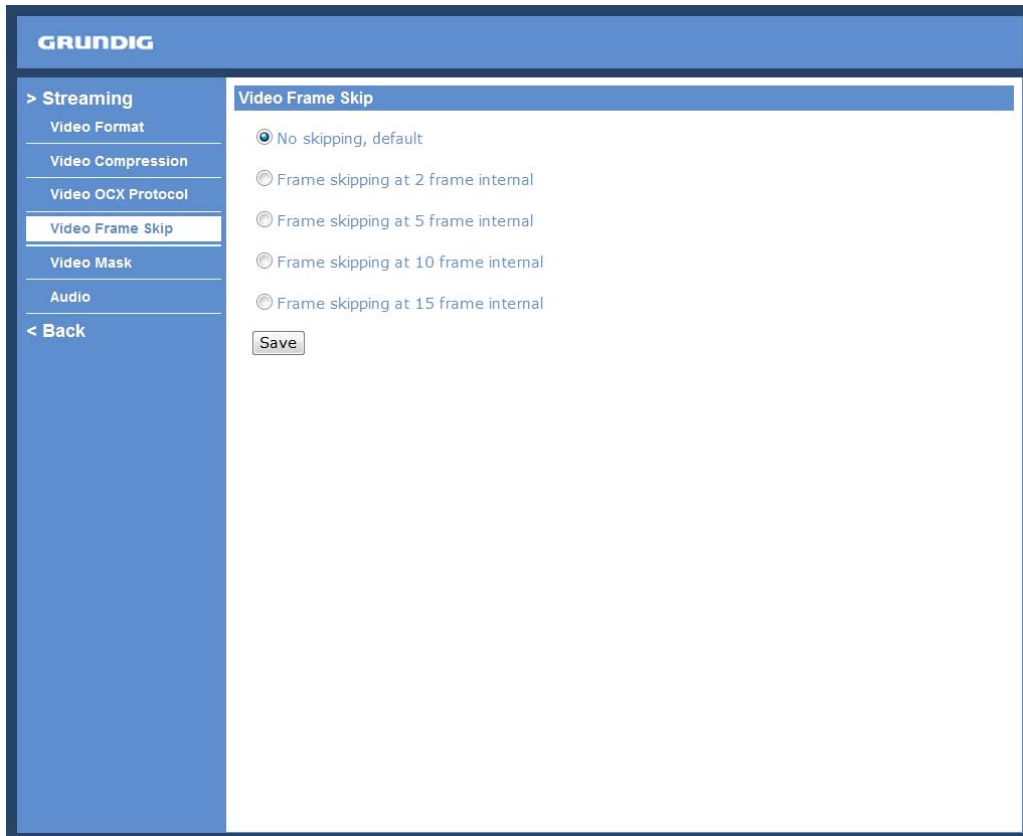

Video Frame Skip options include:

- No skipping, default
- Frame skipping at 2 frame interval
- Frame skipping at 5 frame interval
- Frame skipping at 10 frame interval
- Frame skipping to 15 frame interval

Click "Save" to confirm the setting.

NOTE: Higher frame skipping rate will decrease video smoothness.

## 10.5. Video Mask

There are up to five video masks which can be set by the users.

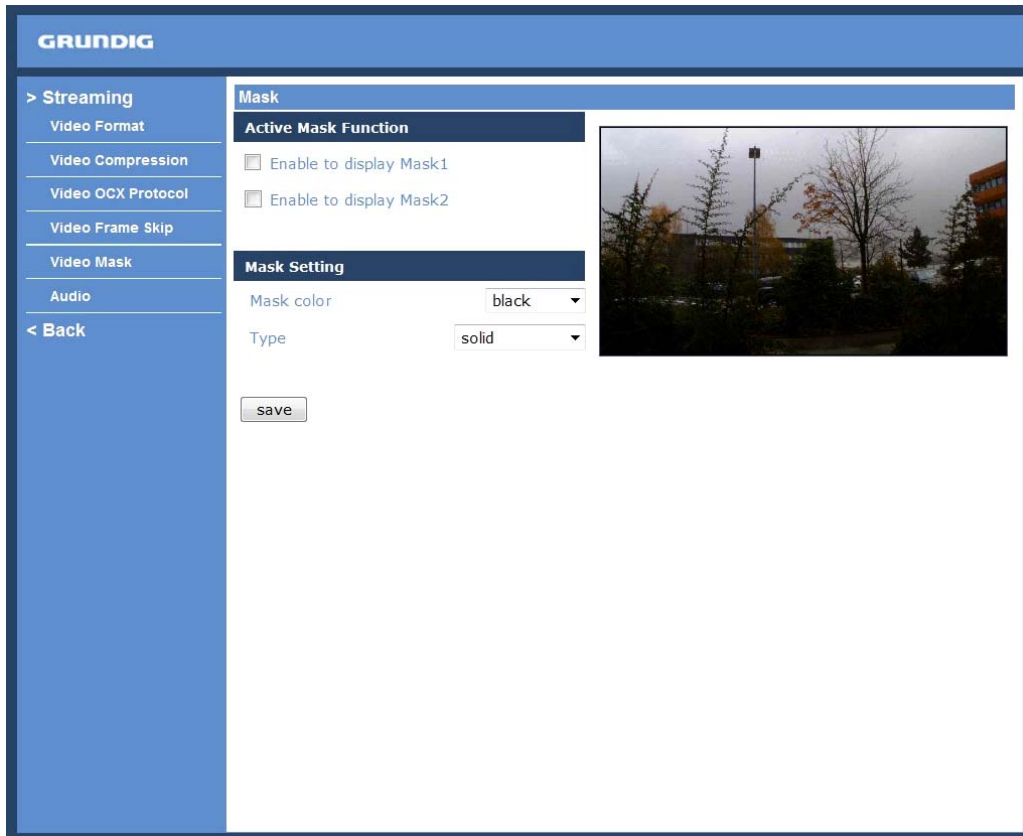

Active Mask Function :

- Add a Mask:

Check a Video Mask checkbox, and a red frame will come out in the Live Video pane at the right side. Use the mouse to drag and drop in order to adjust the mask's size and place it on the target zone.

NOTE: It is suggested to set the Video Mask twice as big as the object.

- Cancel a mask:

Uncheck the checkbox of the Video Mask meant to be deleted, and the selected mask will disappear from the Live Video pane instantly.

Mask Setting :

- Mask colour:

The selection of Mask colours includes red, black, white, yellow, green, blue, cyan, and magenta.

- Type:

Select to change the mask type as solid or transparent.

Click "Save" to confirm the setting.

## 10.6. Audio Mode and Bit Rate Settings

The audio setting page is shown below. In the Audio page, the Administrator can select one transmission mode and audio bit rate.

The screenshot shows the Grundig web interface for audio settings. The left sidebar contains a navigation menu with the following items: '> Streaming', 'Video Format', 'Video Compression', 'Video OCX Protocol', 'Video Frame Skip', 'Video Mask', 'Audio', and '< Back'. The 'Audio' section is selected. The main content area is titled 'Audio' and includes the following settings:

- Transmission Mode:** A group of radio buttons with the following options:
  - Full-duplex (Talk and listen simultaneously)
  - Half-duplex (Talk or listen, not at the same time)
  - Simplex (Talk only)
  - Simplex (Listen only)
  - Disable (selected)
- Server Gain Setting:** Two dropdown menus labeled 'Input gain:' and 'Output gain:', both set to the value '3'.
- Bit Rate:** A dropdown menu set to 'uLAW'.

A 'Save' button is located at the bottom of the settings area.

Transmission Mode :

- Full-Duplex (Talk and Listen simultaneously):

In the Full-Duplex mode, the local and remote sites can communicate with each other simultaneously, i.e. both sites can speak and be heard at the same time.

- Half-Duplex (Talk or Listen, not at the same time):

In the Half-Duplex mode, the local/remote site can only talk or listen to the other site at a time.

- Simplex (Talk only):

In the Talk only Simplex mode, the local/remote site can only talk to the other site.

- Simplex (Listen only):

In the Listen only Simplex mode, the local/remote site can only listen to the other site.

- Disable:

Select the item to turn off the audio transmission function.

Server Gain Setting :

Set the audio input/output gain levels for sound amplification. The audio gain values are adjustable from 1 to 6. The sound will be turned off if the audio gain is set to "Mute".

Bit Rate :

Selectable audio transmission bit rate include 16 Kbps (G.726), 24 Kbps (G.726), 32 Kbps (G.726), 40 Kbps (G.726), uLAW (G.711) and ALAW (G.711). Both uLAW and ALAW signify 64 Kbps but in different compression formats. A higher bit rate signifies a higher audio quality and requires a bigger bandwidth.

Click "Save" to confirm the setting.

## 11. Camera Settings

The picture below is the camera configuration page. Details of each parameter setting are described in the following subsections.

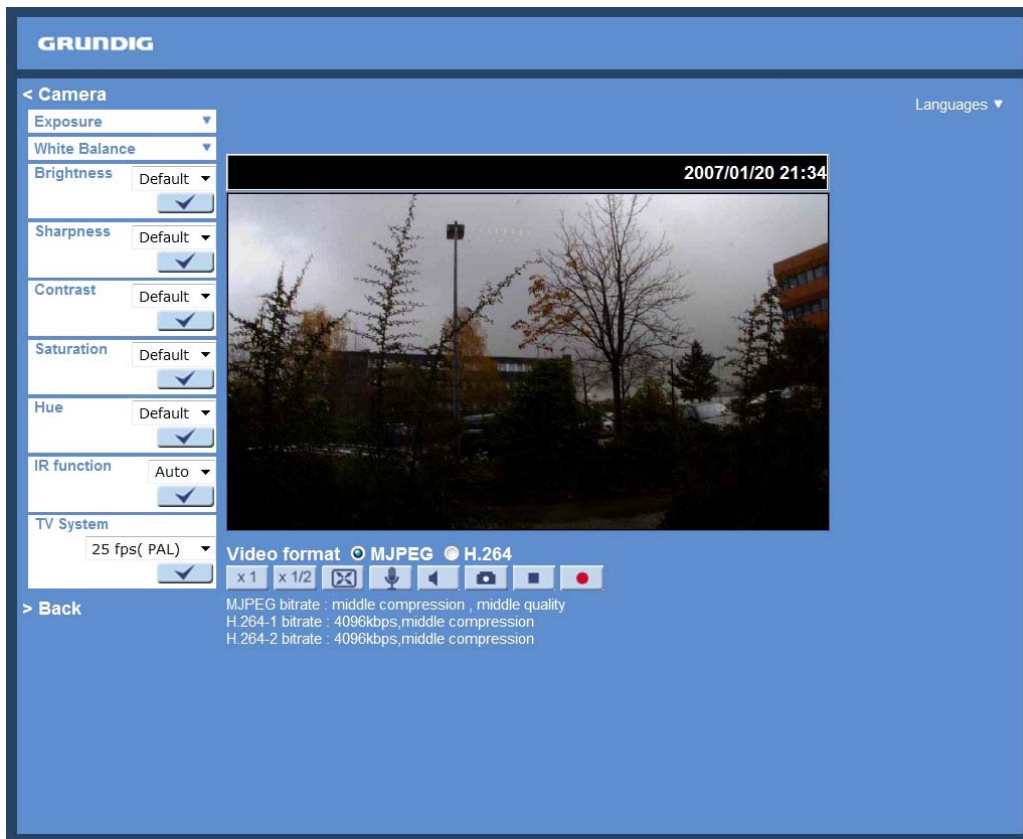

NOTE: Camera settings and function buttons may vary depending on the camera model.

### 11.1. Exposure Setting

The Exposure pull-down menu is as follows:

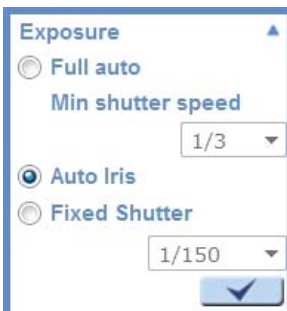

The exposure is the amount of light received by the image sensor and is determined by the width of lens diaphragm opening, the amount of exposure by the sensor (shutter speed) and other exposure parameters. With this item, users can define how the Auto Exposure function works.

Each exposure mode is specified as follows:

Full Auto Mode:

In this mode, the camera's Shutter Speed, IRIS and AGC (Auto Gain Control) control circuits work together automatically to get a consistent video output level. The shutter speed range is from 1 (1/1.5) to 1/30 (1/25) sec. with 6 (5) options. Users can select the suitable shutter speed according to the environmental luminance.

NOTE: The minimum shutter speed set in the Full Auto Mode will be applied to Auto Iris Mode.

Auto Iris Mode :

In this mode, the exposure gives priority to the auto iris. Shutter speed and AGC circuit will function automatically in cooperating with IRIS to get consistent exposure output.



---

NOTE: The minimum shutter speed will vary depending on the setting in Full Auto Mode.

Fixed Shutter Mode :

In this mode, a fixed shutter speed can be selected from the drop-down menu. The shutter speed range is from 1/10000 to 1 (1/1.5) sec. with 19 (18) options. Users can choose a suitable shutter speed according to the environmental illumination.

## 11.2. White Balance Setting

The White Balance pull-down menu is as follows:

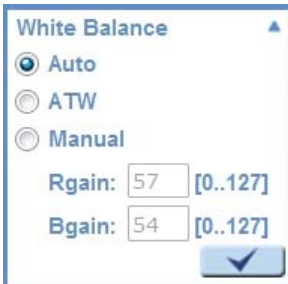

A camera needs to find a reference colour temperature, which is a way of measuring the quality of a light source, for calculating all the other colours. The unit for measuring this ratio is in degree Kelvin (K). Users can select one of the White Balance Control modes according to the operating environment. The following table shows the colour temperature of some light sources for reference.

Light Sources :

- Cloudy Sky (Colour Temperature: 6,000 to 8,000 K)
- Noon Sun and Clear Sky (Colour Temperature: 6,500 K)
- Household Lighting (Colour Temperature: 2,500 to 3,000 K)
- 75-watt Bulb (Colour Temperature: 2,820 K)
- Candle Flame (Colour Temperature: 1,200 to 1,500 K)

Auto Mode :

The Auto Balance White mode is suitable for an environment with a light source having a colour temperature ranging from 2700 ~ 7600K.

ATW Mode (Auto Tracing White Balance) :

With the Auto Tracking White Balance function\*, the white balance in a scene will be automatically adjusted while temperature colour is changing. The ATW Mode is suitable for an environment with a wider range of lighting conditions from 2500 ~ 9800K.

\* This function is only available in GCI-K0503B and GCI-H0602B.

Indoor/Outdoor Mode :

Select Indoor or Outdoor.

\* This function is only available in GCI-H0503B.

Manual Mode :

In this mode, users can change the White Balance value manually. For GCI-K0503B and GCI-H0602B, users can select a number between 0 ~ 127 in the "R-Gain/B-Gain" item to gain the red/blue illuminant on the Live Video Pane. For GCI-H0503B, users can select a number between 1 ~ 11.

Press < √ > to confirm the new setting.

## 11.3. Backlight Setting

Based on various lighting situations, users can select to turn on or off the function of Backlight Compensation\* to optimize the video quality. The default value of Backlight is Off.

Press < √ > to confirm the new setting.

\* The Backlight Compensation is only available for GCI-H0503B.

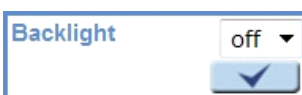

---

#### 11.4. Brightness Setting

Users can adjust the image's brightness by adjusting the item. To increase video brightness, select a bigger number.

Press < √ > to confirm the new setting.



#### 11.5. Sharpness Setting

##### Sharpness Setting

Increasing the sharpness level can make the image look sharper; it especially enhances the object's edges.

Press < √ > to confirm the new setting.

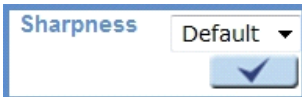

#### 11.6. Contrast Setting

The camera image contrast level is adjustable; please choose from a range of -6 to +19. Press < √ > to confirm the new setting.

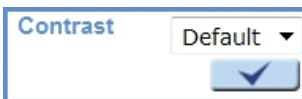

#### 11.7. Saturation Setting

The camera image saturation level is adjustable; please select from a range of -6 to +19.

Press < √ > to confirm the new setting.

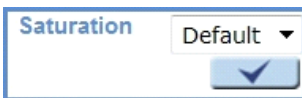

#### 11.8. Hue Setting

The camera image hue level\* is adjustable; please select from a range of -12 to +13.

Press < √ > to confirm the new setting.

\* The Hue Function is only available for GCI-H0602B and GCI-K0503B.

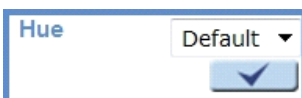

#### 11.9. Digital Zoom Setting

The camera's Digital Zoom\* is adjustable from x1 to x16. Press < √ > to confirm the new setting.

\* The Digital Zoom function is only available for GCI-H0503B.

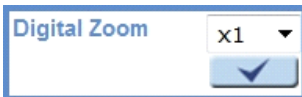

#### 11.10. IR Function

With the IR cut filter, the Dome Camera can still catch a clear image at night time or in low light conditions. Press < √ > to confirm the new setting.

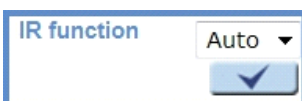

### 11.11. WDR Function

The Wide Dynamic Range (WDR) function\* is for solving high contrast or changing light issues so that it improves the video display. The WDR is adjustable from level 1 to 4. A higher level of WDR represents a wider dynamic range, so that the IP Camera can catch a greater scale of brightness.

Press < √ > to confirm the new setting.

\* The WDR function is only available for GCI-H0503B.



### 11.12. 3DNR Function

With the 3D Noise Reduction (3DNR) function\*, the IP Camera can deliver clearer images in low-light conditions. Press < √ > to confirm the new setting.

\* The 3DNR function is only available for GCI-H0503B.



### 11.13. TV System Setup

Select the video format that matches the present TV system.

Press < √ > to confirm the new setting.

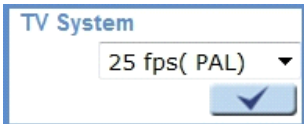

## 12. Logout

Press the tab "Logout" at the top of the page, and the login window will pop up. This permits login with another user name.

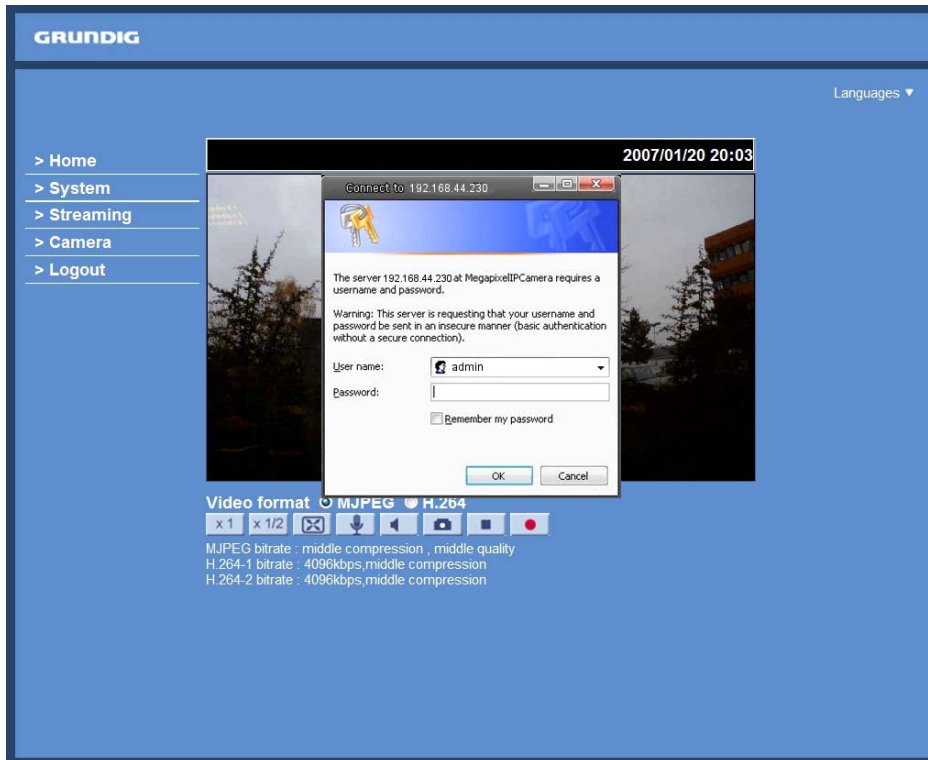

### 13. CMS Software Introduction

The Central Management System (CMS) software bundles the IP cameras into one system. Offering powerful functionalities via intuitive interface, it is a centralized monitoring solution for your video surveillance equipments.

It gives the user access to monitor multiple IP Cameras, and allows the user to simultaneously monitor 16 sites per group (up to 10 groups) within several clicks.

For further information on CMS software, please refer to the supplied CD.

NOTE: The free bundle CMS is a function-limited software. For additional features, please purchase a licensed CMS.



### 14. Internet Security Settings

If ActiveX control installation is blocked, please either set Internet security level to default or change ActiveX controls and plug-in settings.

Internet Security Level : Default

Step 1: Start the Internet Explorer (IE).

Step 2: Select <Tools> from the main menu of the browser. Then Click <Internet Options>.

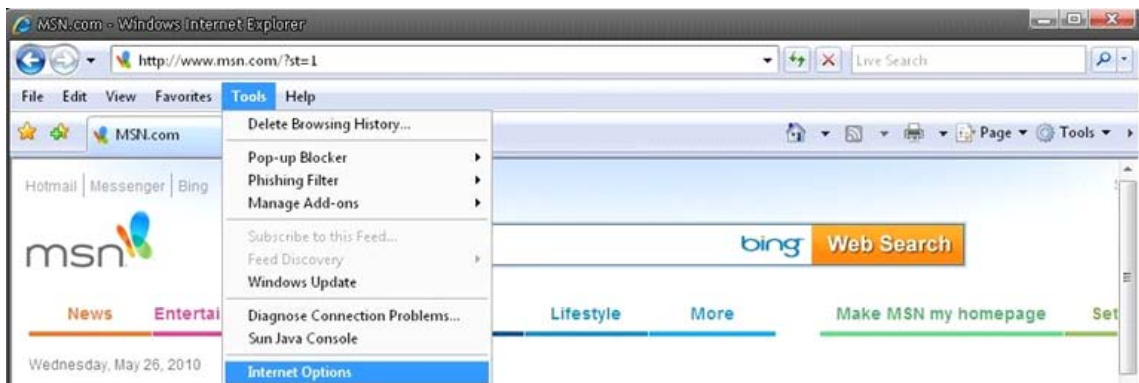

Step 3: Click the <Security> tab, and select <Internet>.

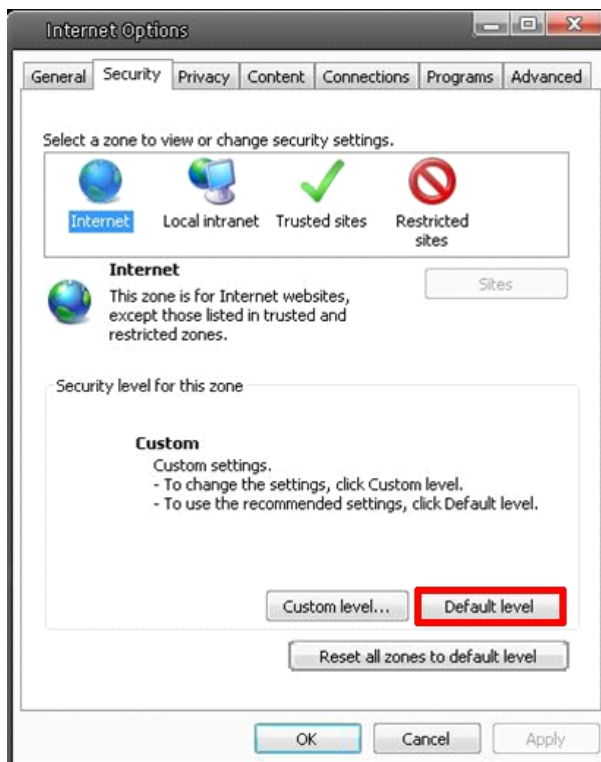

Step 4: Down the page, press “Default Level” (see the picture above) and click “OK” to confirm the setting. Close the browser window, and open a new one later when accessing the IP Camera.

ActiveX Controls and Plug-in Settings :

Step 1~3: Refer to the previous section above.

Step 4: Down the page, press “Custom Level” (see the picture below) to change ActiveX controls and plug-in settings.

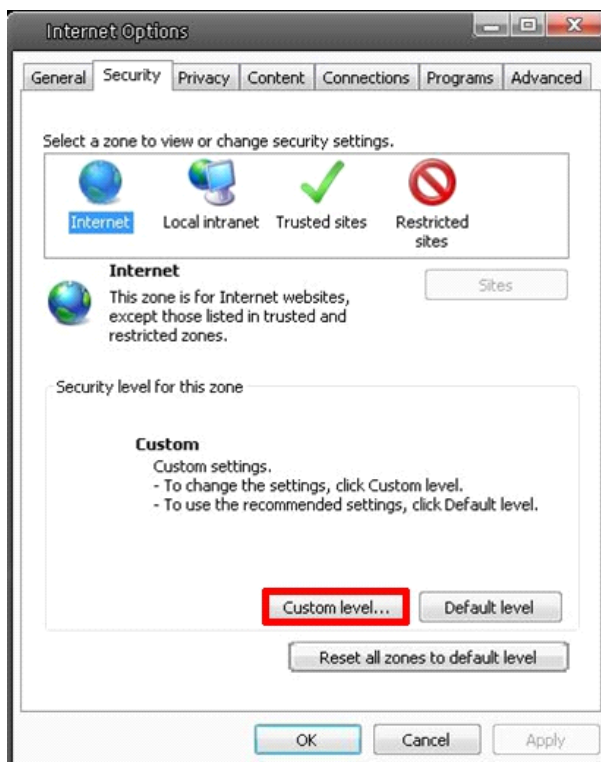

---

The Security Settings screen is displayed as shown below:

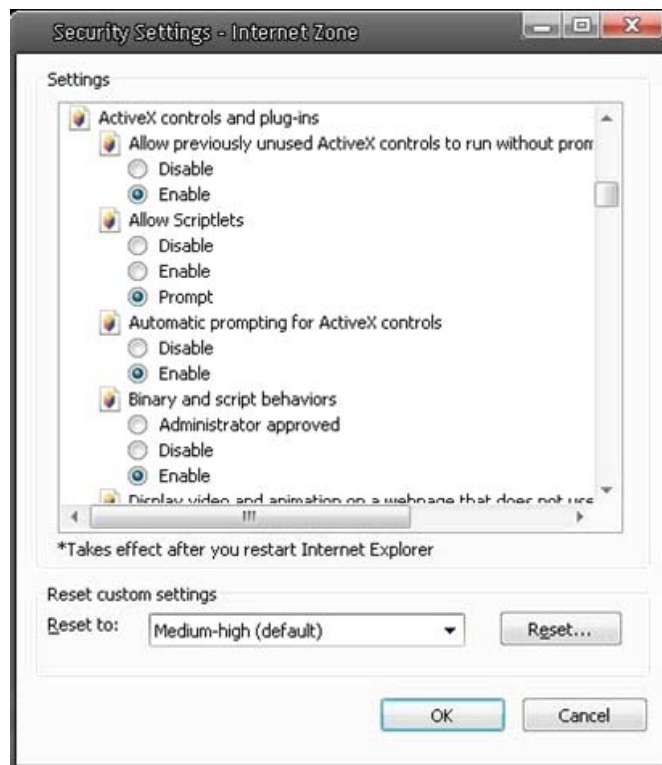

Step 5: Under “ActiveX controls and plug-ins”, set ALL items (as listed below) to <Enable> or <Prompt>. Please note that the items may vary depending on the Internet Explorer version you are using.

ActiveX controls and plug-in settings:

1. Allow previously unused ActiveX controls to run without prompt
2. Allow Scriptlets
3. Automatic prompting for ActiveX controls.
4. Binary and script behaviors
5. Display video and animation on a webpage that does not use external media player
6. Download signed ActiveX controls
7. Download unsigned ActiveX controls
8. Initialize and script ActiveX controls not marked as safe for scripting
9. Run ActiveX controls and plug-ins
10. Script ActiveX controls marked as safe for scripting

Step 6: Click <OK> to accept the settings and to close the Security screen.

Step 7: Click <OK> to close the Internet Options screen.

Step 8: Close the browser window, and restart a new one later for accessing the IP Camera.

---

## 15. GRUNDIG Viewer Download Procedure

The procedure of GRUNDIG Viewer software download is specified as follows:

Step 1: In the GRUNDIG Viewer installation page, click “Next” for starting the installation.



Step 2: Setup starts. Please wait for a while until the loading bar runs out.

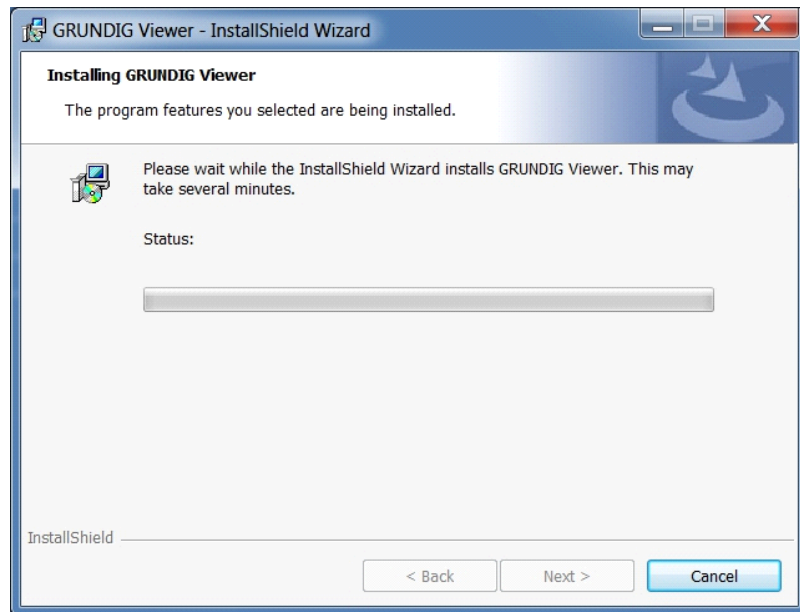

Step 3: Click "Finish" to close the GRUNDIG Viewer installation page.

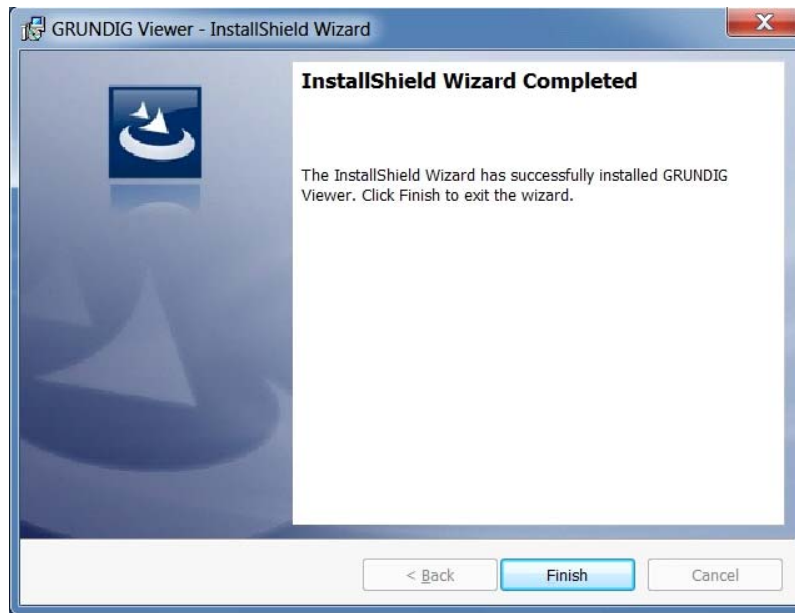

Then, the IP Camera's Home page will display as follows:

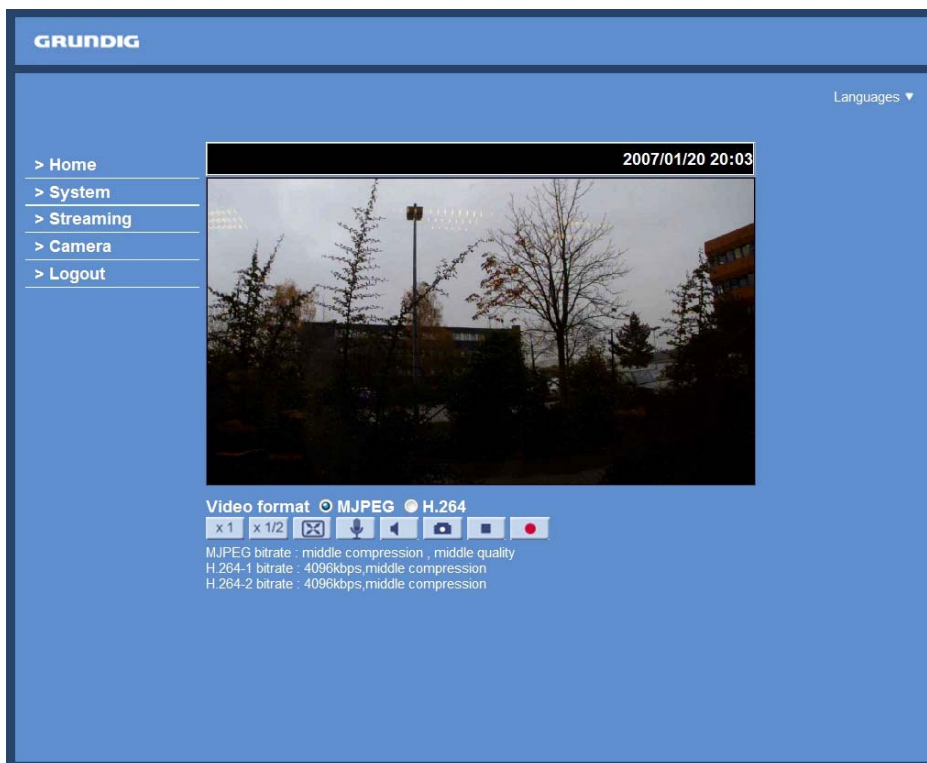

NOTE: Please note that the function buttons may vary depending on the camera model.



## 16. Install UPnP Components

Please follow the instructions below to install UPnP components. (The procedure is for Windows XP, for other systems please refer to the corresponding manuals.)

Step 1: Go to "Start", click on "Control Panel", and then double-click on "Add or Remove Programs".

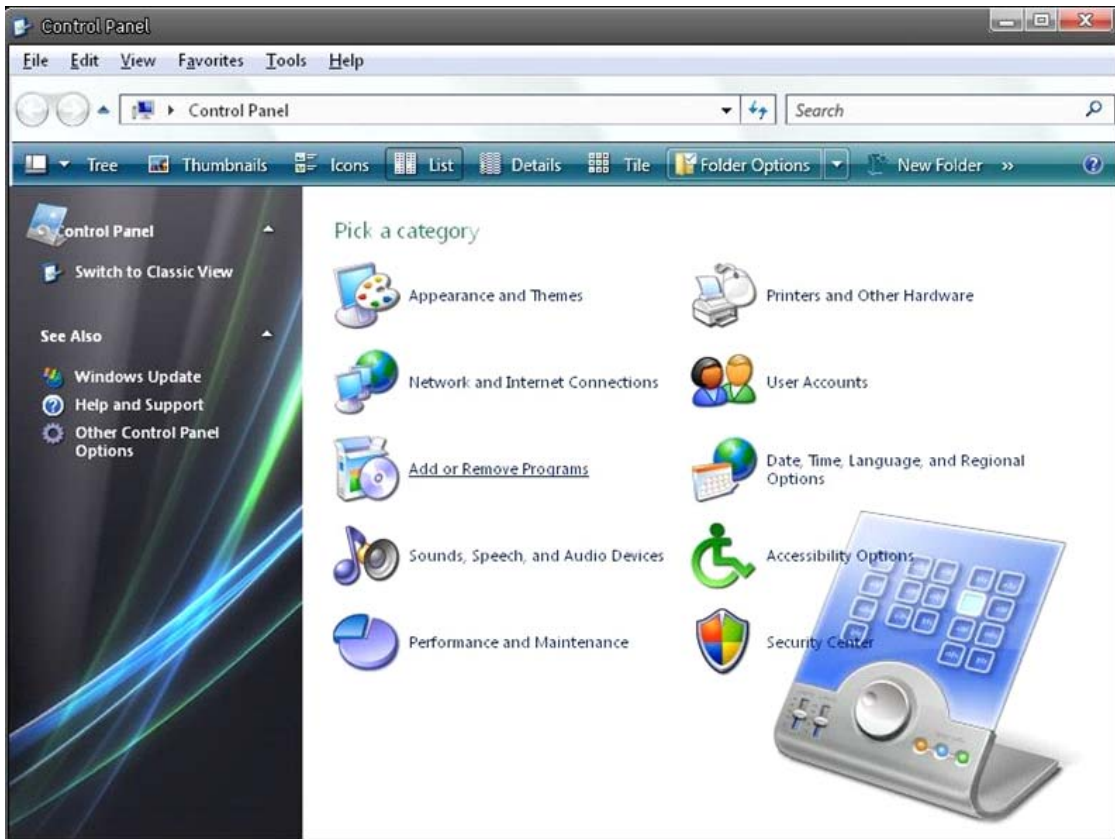

Step 2: Click on "Add/Remove Windows Components" in the Add or Remove Programs page.

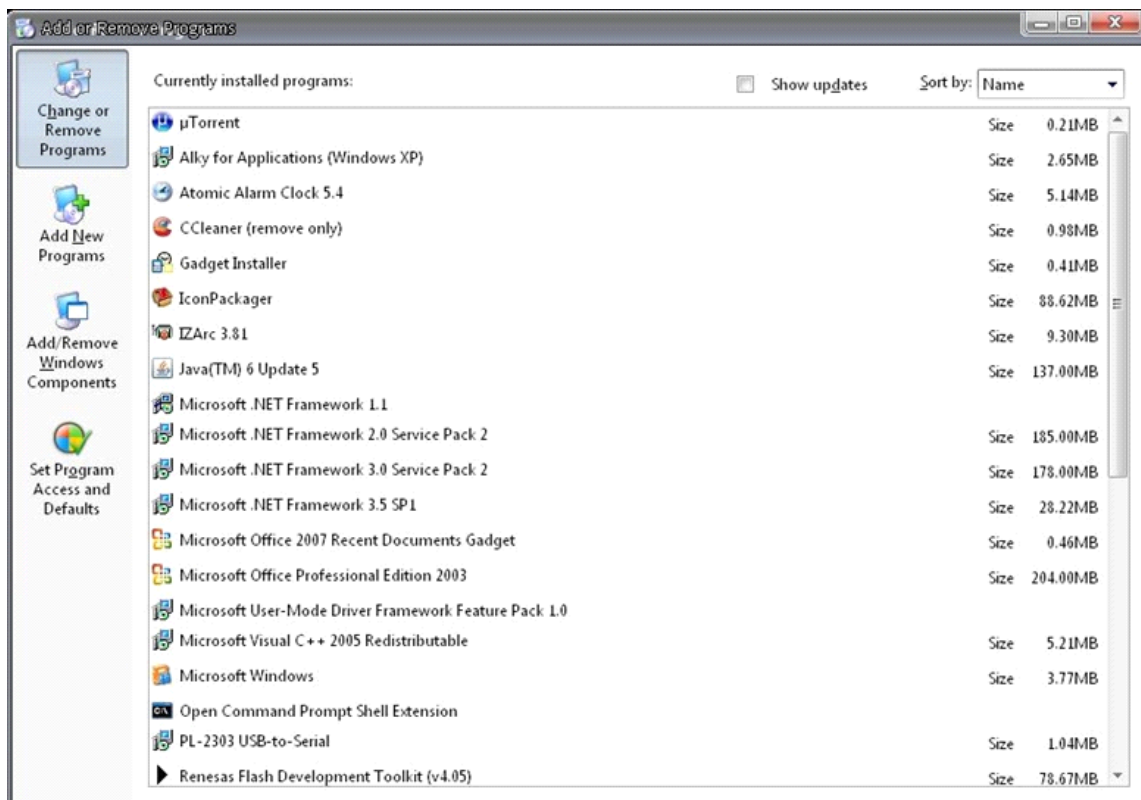

Step 3: Select "Networking Services" from the Components list in the Windows Components Wizard window, and then click "Details".

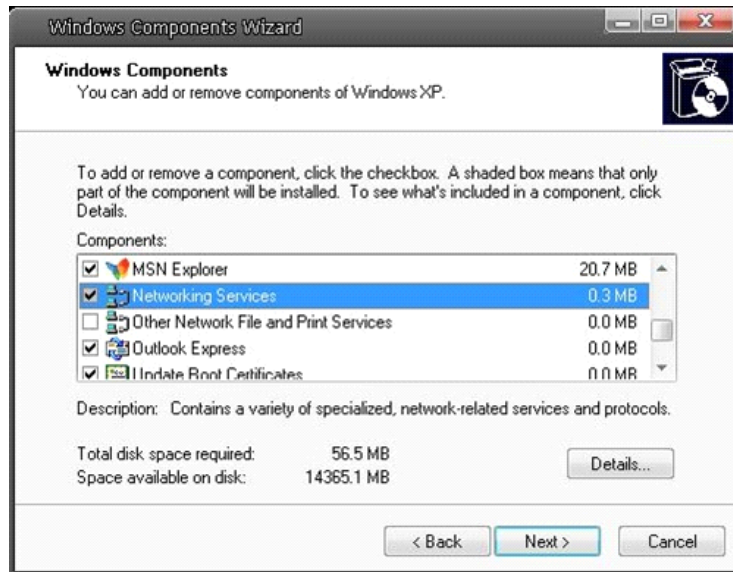

Step 4: Select "UPnP User Interface" in the Networking Services' subcomponents list and then click "OK".

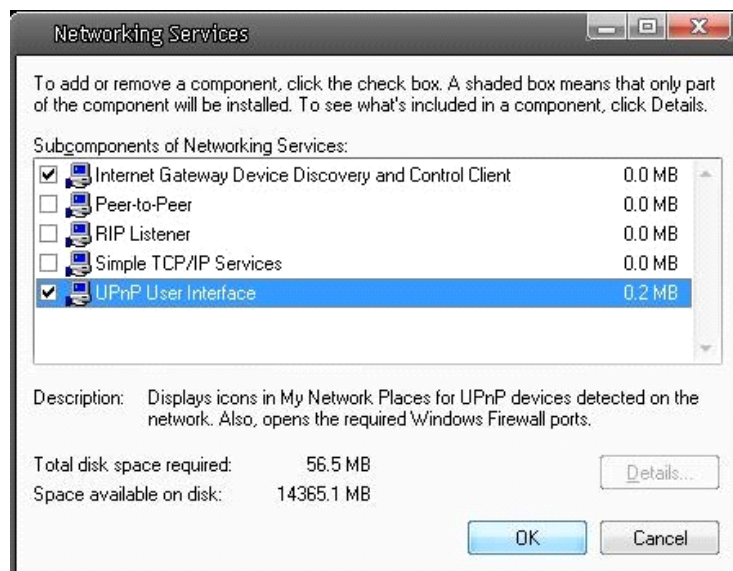

Step 5: Click "Next" in the Windows Components Wizard page.

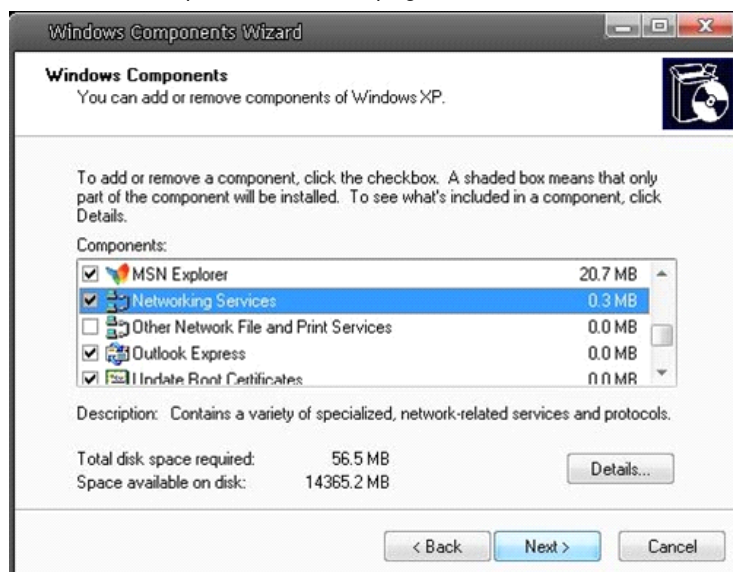

Step 6: Click "Finish" to complete the installation.



---

## 17. Back Focus Adjustment

When to adjust the back focus:

Back Focus refers to the distance from the rear lens element to the camera focal plane. In most cases, it is only required to adjust the back focus only when the focus cannot be adjusted throughout its zoom range.

Requirements:

Tools required when carrying out back focus adjustment include:

1. Back focus adjuster (in the package of the IP camera)
2. Test chart / contrasting object

How to adjust the back focus:

Step 1: Set the camera on a stable mount, with the test chart or object at least 75 feet (23 meters) away (or as far as possible). Please loosen the focus ring's retaining screw with the supplied back focus adjuster.



Step 2: Make sure the iris is wide open. Therefore, it is advised to keep the environment in low light condition. To open the automatic lens completely, please use a neutral density filter. With this filter it is possible to simulate a low light condition so that the lens can open up completely.

Step 3: Adjust the focus to infinite far ( $\infty$ ).

Step 4: Turn the zoom to the wide angle (telephoto) position, and then focus with the back focus on the subject.

Step 5: Set the zoom to the most extreme wide angle (telephoto) position.

Step 6: Focus on the object with the back focus ring. Check now whether it is possible to adjust the focus with the back focus ring also in the wide angle range.

Step 7: Repeat steps 3 ~ 6 until the focus can be adjusted throughout the zoom range. When using a zoom lens and changing the focal length, the focus does not need to be adjusted again once the back focus adjustment has been completed. This does not apply to vario lenses.

Step 8: Tighten the back focus ring's retaining screw to fix the ring.

---

**Specifications GCI-H0503B**

Image Sensor	1/3" CCD, 1.3 megapixel
Col/B&W	On/Off/Auto, IR-cut filter removable (ICR)
Pixels - total	1280 (H) x 960 (V)
Sensitivity	0.03 lux @ F1.2 (Colour) / 0.001 lux @ F1.2 (B&W)
Lens Mount	C/CS mount
Lens Drive Type	Auto iris, DC
Motion Detection	On/ Off/ Sensitivity/ Area setting
Privacy zones	5 zones, rectangle
BLC	On/Off + WDR
White Balance	Auto, Indoor, Outdoor, Manual
Digital Noise Reduction (DNR)	Off/Low/High
Shutter Speed	1 sec to 1/10,000 sec
Camera ID	20 character
Alarm Inputs	1
Alarm Outputs	1
Web Browser	MS Internet Explorer 6.0 (or higher)
Number of Clients	Up to 20 users
Video Compression	Dual stream: H.264+H.264, H.264+MJPEG, MJPEG+BNC, H.264+BNC or MJPEG+MPEG-4
Video Resolution	1280 X 960 (12 fps), 1280 X 720 (25 fps)
Network Protocol	IPv4, IPv6, TCP/IP, UDP, RTP, RTSP, HTTP, HTTPS, ICMP, FTP, SMTP, DHCP, PPPoE, UPnP, IGMP, 802.1X and SNMP
SD memory	Micro SD/SDHC
Alarm Event	Alarm Input, Motion Detection or Schedule: Image transfer or alarm message by FTP, Image transfer or alarm message by E-mail, recording on SD-card, enable alarm output and send HTTP notification
Audio Compression	G.726 ADPCM, G.711
LED Indicator	Power, link, active
Video Outputs	1Vpp, BNC
Input/Output sockets	Video Out(BNC), Power(3-Pin Term), RJ-45, Micro SD Card Slot, Alarm Terminal 4-Pin (Alarm In 2-Pin, Alarm Out 2-Pin), Audio (2 mini Jack 3.5mm)
Firmware Upgrade	Firmware upgrade by Web Browser
Configuration	Upload & Download configuration on remote PC
Operating Temperature	0°C ~ +50°C
Humidity	10 ~ 90% no condensation
Regulation	CE, FCC, RoHS Compliant
Supply Voltage	12 VDC / 24 VAC / PoE IEEE 802.3af
Power Consumption	6 W
Weight	0.36 kg
Dimensions (wxhxd)	76 x 53 x 126 mm

**Specifications GCI-H0602B**

Image Sensor	1/2.7" CMOS Omnivision, 2 megapixel
Col/B&W	Auto/Electronic
Pixels - total	1920(H) x 1080(V), Full HD
Sensitivity	0.2 lux @ F1.2
Video Resolution	Full HD 1920 x 1080 (12 fps), 720P 1280 X 720 (25 fps)
Supply Voltage	12 VDC / PoE IEEE 802.3af
Power Consumption	4 W
Weight	0.36 kg
Dimensions (wxhxd)	76 x 53 x 126 mm

**Specifications GCI-K0503B**

Image Sensor	1/2.7" CMOS Omnivision, 2 megapixel
Col/B&W	On/Off/Auto, IR-cut filter removable (ICR)
Pixels - total	1920(H) x 1080(V), Full HD

---

---

Sensitivity	0.2 lux @ F1.2 (Colour) / 0.02 lux @ F1.2 (B&W)
Video Resolution	Full HD 1920 x 1080 (25 fps), 720P 1280 X 720 (2x25 fps)
Supply Voltage	12 VDC / 24 VAC / PoE IEEE 802.3af
Power Consumption	5.5 W
Weight	0.36 kg
Dimensions (wxhxd)	76 x 53 x 126 mm

---

### Dimensions

---

